



TFE



TFA



TFT



TFP



TFN



TFM



TFF



TFS

CHARACTERISTICS

- Pilot hole in concrete needed, thread is created by the anchor during the installation process.
- Use for high loads. High fire resistance.
- Assessed for 2 installation depths and 3 for Ø10.
- Use in cracked and non-cracked concrete.
- Comply with guideline VdS CEA 4001:2021-01(07) "Guidelines for sprinklers systems. Planning and installation"
- Suitable when reduced edge distances or spacing required.
- Qualified for static and quasi-static.
- Easy installation.
- Installation through the fixture.
- Reusable
- Removable, leaving concrete surface flat.
- Variety of lengths and sizes, assembly flexibility.
- VdS available from Ø6 to Ø18
- Available in INDEXcal

APPLICATION

- Structural fixings in cracked and uncracked concrete subject to dry internal conditions.
- Glazing, windows and storefronts
- Racking and shelving
- Attaching railings, handrails and ledgers
- Fixings wood structures in concrete

ASSESSMENTS



BASE MATERIAL



SIZE RANGE

Ø5 - Ø18

DRILL CONDITION



DRY

WET

FLOODED





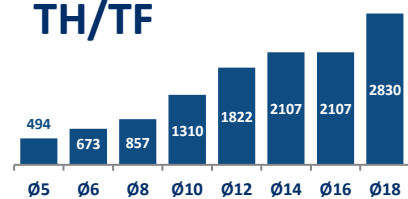











MAXIMUM LOADS RECOMMENDED FOR CRACKED AND UNCRACKED CONCRETE [kg]

TH/TF



APPLICATION EXAMPLES



1. RANGE						
ITEM	CODE	SIZES	PHOTO	DESCRIPTION	MATERIAL	COVERING
1	TFE	Ø5 - Ø18		Hexagonal head with flange screw anchor	Carbon steel, zinc plated coating ≥ 5 µm	
2	TFA	Ø5 - Ø10		Countersunk screw anchor	Carbon steel, zinc plated coating ≥ 5 µm	
3	TFT	Ø6		Truss head screw anchor	Carbon steel, zinc plated coating ≥ 5 µm	
4	TFP	Ø5 - Ø8		Pan head screw anchor	Carbon steel, zinc plated coating ≥ 5 µm	
5	TFN	Ø14		Hexagonal head screw anchor	Carbon steel, zinc plated coating ≥ 5 µm	
6	TFF	Ø5 - Ø8		Rod hanger internal thread screw anchor	Carbon steel, zinc plated coating ≥ 5 µm	
7	TFM	Ø6		Hexagonal head with flange and with external thread screw anchor	Carbon steel, zinc plated coating ≥ 5 µm	
8	TFS	Ø6 - Ø10		Stud head screw anchor	Carbon steel, zinc plated coating ≥ 5 µm	

2. INSTALLATION DATA

2.1. INSTALLATION DRAWING

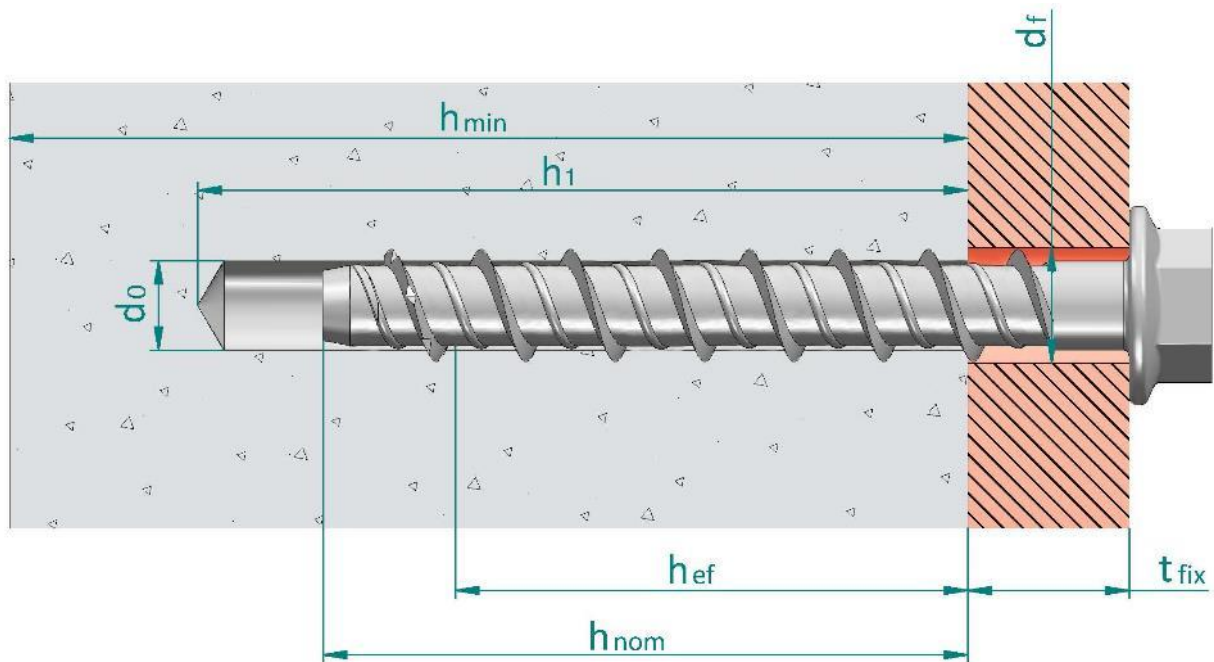

- d_0 : Nominal diameter of drill bit
- d_b : Bottom flange thickness
- d_f : Fixture clearance hole diameter
- h_{ef} : Effective anchorage depth
- h_1 : Depth of drilled hole
- h_{nom} : Overall fastener embedment depth in the concrete
- h_{min} : Minimum thickness of concrete member
- t_{fix} : Fixture thickness

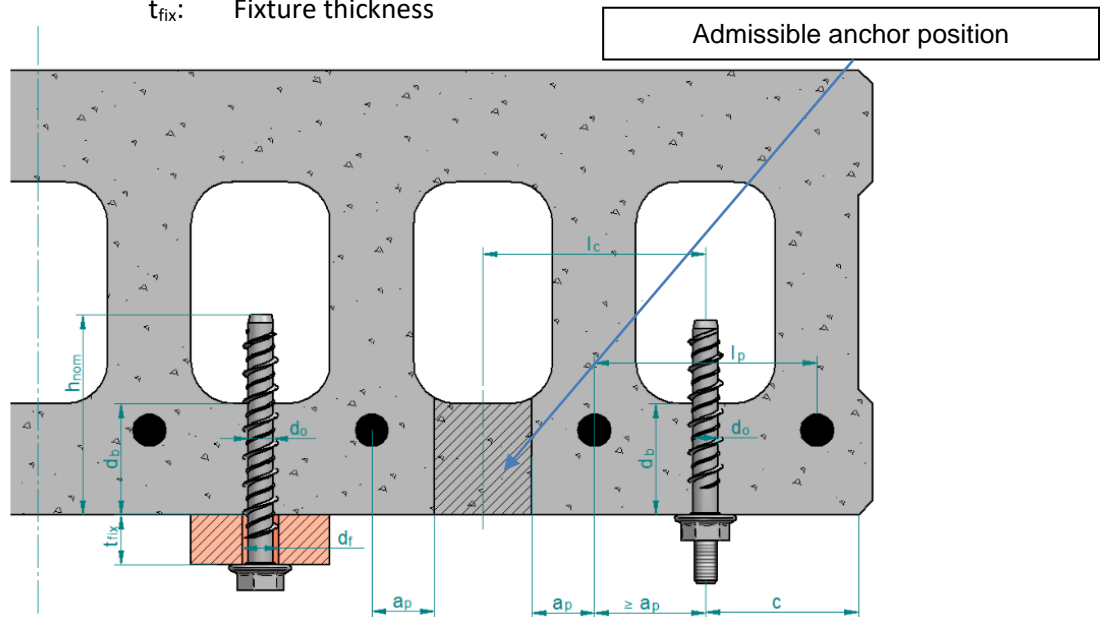

2.2. SEISMIC LOAD ASSESSMENT

Family	Code	Size (Letter)	Assessed	C1	C2	Family	Code	Size (Letter)	Assessed	C1	C2
[--]	[--]	[--]	ETA	[--]	[--]	[--]	[--]	[--]	ETA	[--]	[--]
TFE	TFE05040	Ø5 x 40 (A)	✓*	--	--	TFA	TFA05040	Ø5 x 40 (A)	✓*	--	--
	TFE05050	Ø5 x 50 (A)	✓*	--	--		TFA05060	Ø5 x 60 (B)	✓*	--	--
	TFE05060	Ø5 x 60 (B)	✓*	--	--		TFA05080	Ø5 x 80 (D)	✓*	--	--
	TFE05080	Ø5 x 80 (D)	✓*	--	--		TFA05100	Ø5 x 100 (E)	✓*	--	--
	TFE05100	Ø5 x 100 (E)	✓*	--	--		TFA06045	Ø6 x 45	✓	--	--
	TFE06035	Ø6 x 35	✓	--	--		TFA06050	Ø6 x 50	✓	--	--
	TFE06040	Ø6 x 40	✓	--	--		TFA06060	Ø6 x 60	✓	✓	--
	TFE06045	Ø6 x 45	✓	--	--		TFA06080	Ø6 x 80	✓	✓	--
	TFE06050	Ø6 x 50	✓	--	--		TFA06100	Ø6 x 100	✓	✓	--
	TFE06060	Ø6 x 60	✓	✓	--		TFA06120	Ø6 x 120	✓	✓	--
	TFE06070	Ø6 x 70	✓	✓	--		TFA06140	Ø6 x 140	✓	✓	--
	TFE06080	Ø6 x 80	✓	✓	--		TFA08060	Ø8 x 60	✓	✓	✓
	TFE06100	Ø6 x 100	✓	✓	--		TFA08080	Ø8 x 80	✓	✓	✓
	TFE06120	Ø6 x 120	✓	✓	--		TFA08100	Ø8 x 100	✓	✓	✓
	TFE08055	Ø8 x 55	✓	✓	✓		TFA08120	Ø8 x 120	✓	✓	✓
	TFE08060	Ø8 x 60	✓	✓	✓		TFA10100	Ø10 x 100	✓	✓	✓
	TFE08070	Ø8 x 70	✓	✓	✓		TFA10120	Ø10 x 120	✓	✓	✓
	TFE08075	Ø8 x 75	✓	✓	✓		TFT06040	Ø6 x 40	✓	--	--
	TFE08080	Ø8 x 80	✓	✓	✓		TFT06050	Ø6 x 50	✓	--	--
	TFE08090	Ø8 x 90	✓	✓	✓		TFT06060	Ø6 x 60	✓	✓	--
	TFE08100	Ø8 x 100	✓	✓	✓	TFP05040	Ø5 x 40 (A)	✓*	--	--	
	TFE08110	Ø8 x 110	✓	✓	✓	TFP05060	Ø5 x 60 (B)	✓*	--	--	
	TFE08120	Ø8 x 120	✓	✓	✓	TFP06040	Ø6 x 40	✓	--	--	
	TFE08140	Ø8 x 140	✓	✓	✓	TFP06050	Ø6 x 50	✓	--	--	
	TFE10060	Ø10 x 60	✓	--	--	TFP06060	Ø6 x 60	✓	✓	--	
	TFE10070	Ø10 x 70	✓	--	--	TFP06080	Ø6 x 80	✓	✓	--	
	TFE10080	Ø10 x 80	✓	--	--	TFP06100	Ø6 x 100	✓	✓	--	
	TFE10090	Ø10 x 90	✓	✓	✓	TFP08060	Ø8 x 60	✓	✓	✓	
	TFE10100	Ø10 x 100	✓	✓	✓	TFP08080	Ø8 x 80	✓	✓	✓	
	TFE10120	Ø10 x 120	✓	✓	✓	TFF05035S	Ø5 x 35 (M6)	✓*	--	--	
	TFE10140	Ø10 x 140	✓	✓	✓	TFF06035	Ø6 x 35 (M8-M10)	✓	--	--	
	TFE10160	Ø10 x 160	✓	✓	✓	TFF06040	Ø6 x 40 (M8-M10)	✓	--	--	
	TFE10180	Ø10 x 180	✓	✓	✓	TFF06055	Ø6 x 55 (M8-M10)	✓	--	--	
	TFE12080	Ø12 x 80	✓	--	--	TFF08050T	Ø8 x 50 (M10)	✓	--	--	
	TFE12090	Ø12 x 90	✓	--	--	TFF08050W	Ø8 x 50 (M12)	✓	--	--	
	TFE12100	Ø12 x 100	✓	--	--	TFM06035	Ø6 x 35 (M8)	✓	--	--	
	TFE12110	Ø12 x 110	✓	✓	✓	TFM06055	Ø6 x 55 (M10)	✓	--	--	
	TFE12130	Ø12 x 130	✓	✓	✓	TFN14080	Ø14 x 80	✓	--	--	
	TFE12150	Ø12 x 150	✓	✓	✓	TFS06100	Ø6 x 100 (M8)	✓	✓	--	
	TFE14080	Ø14 x 80	✓	--	--	TFS06120	Ø6 x 120 (M8)	✓	✓	--	
TFE14100	Ø14 x 100	✓	--	--	TFS08110	Ø8 x 110 (M10)	✓	✓	✓		
TFE14110	Ø14 x 110	✓	--	--	TFS08130	Ø8 x 130 (M10)	✓	✓	✓		
TFE14120	Ø14 x 120	✓	✓	✓	TFS10120	Ø10 x 120 (M12)	✓	--	--		
TFE14130	Ø14 x 130	✓	✓	✓	TFS10140	Ø10 x 140 (M12)	✓	--	--		
TFE14140	Ø14 x 140	✓	✓	✓							
TFE14160	Ø14 x 160	✓	✓	✓							
TFE16100	Ø16 x 100	✓	--	--							
TFE16150	Ø16 x 150	✓	--	--							
TFE18100	Ø18 x 100	✓	--	--							
TFE18130	Ø18 x 130	✓	--	--							
TFE18160	Ø18 x 160	✓	✓	✓							
TFE18180	Ø18 x 180	✓	✓	✓							
TFE18200	Ø18 x 200	✓	✓	✓							

3. INSTALLATION PARAMETERS (CONCRETE)

General Installation parameters										Standard Installation depth ($h_{ef, std}$)								Reduced Installation depth ($h_{ef, red}$)										
Family	Code	Size (Letter)	Assessed	Drill bit diameter	Fixture clearance hole	Spanner	Maximum torque	Minimum allowable spacing	Minimum allowable edge distance	Minimum concrete thickness	Depth of drill hole	Installation depth	Effective anchorage depth	Thickness of fixture	Critical spacing (concrete cone)	Critical edge distance (cone)	Critical spacing (splitting)	Critical edge distance (splitting)	Minimum concrete thickness	Depth of drill hole	Installation depth	Effective anchorage depth	Thickness of fixture	Critical spacing (concrete cone)	Critical edge distance (cone)	Critical spacing (splitting)	Critical edge distance (splitting)	
[--]	[--]	[--]	ETA	d_0 [mm]	d_f [mm]	SW/Tx [--]	T_{inst} [Nm]	S_{min} [mm]	C_{min} [mm]	h_{min} [mm]	h_1 [mm]	h_{nom} [mm]	h_{ef} [mm]	t_{fix} [mm]	$S_{cr,N}$ [mm]	$C_{cr,N}$ [mm]	$S_{cr,sp}$ [mm]	$C_{cr,sp}$ [mm]	h_{min} [mm]	h_1 [mm]	h_{nom} [mm]	h_{ef} [mm]	t_{fix} [mm]	$S_{cr,N}$ [mm]	$C_{cr,N}$ [mm]	$S_{cr,sp}$ [mm]	$C_{cr,sp}$ [mm]	
TFE	TFE05040	Ø5 x 40(A)	✓*	5	6,5 - 8	SW 8	8	35	35	--	--	--	--	--	--	--	--	--	80	45	35	26,5	5	80	40	80	40	
	TFE05050	Ø5 x 50(A)	✓*			SW 8				5	105	53	105	53	15													
	TFE05060	Ø5 x 60(B)	✓*			SW 8				15	105	53	105	53	35													
	TFE05080	Ø5 x 80(D)	✓*			SW 8				35	105	53	105	53	45													
	TFE05100	Ø5 x 100(E)	✓*			SW 8				55	105	53	105	53	65													
	TFE06035	Ø6 x 35	✓	6	7,5 - 9	SW 10	10	35	35	--	--	--	--	--	--	--	--	--	--	100	45	35	26,0	--	78	39	90	45
	TFE06040	Ø6 x 40	✓			SW 10				5	--	--	--															
	TFE06045	Ø6 x 45	✓			SW 10				10	--	--	--															
	TFE06050	Ø6 x 50	✓			SW 10				15	--	--	--															
	TFE06060	Ø6 x 60	✓			SW 10				25	129	65	170	85	35													
	TFE06070	Ø6 x 70	✓			SW 10				45	129	65	170	85	45													
	TFE06080	Ø6 x 80	✓			SW 10				65	129	65	170	85	65													
	TFE06100	Ø6 x 100	✓			SW 10				85	129	65	170	85	85													
	TFE06120	Ø6 x 120	✓			SW 10				100	129	65	170	85	100													
	TFE08055	Ø8 x 55	✓			SW 13				5	--	--	--	--	5													
	TFE08060	Ø8 x 60	✓	SW 13	10	--	--	--	--	10																		
	TFE08070	Ø8 x 70	✓	SW 13	15	--	--	--	--	15																		
	TFE08075	Ø8 x 75	✓	SW 13	25	152	76	200	100	25																		
	TFE08080	Ø8 x 80	✓	SW 13	35	152	76	200	100	35																		
	TFE08090	Ø8 x 90	✓	SW 13	45	152	76	200	100	45																		
	TFE08100	Ø8 x 100	✓	SW 13	55	152	76	200	100	55																		
	TFE08110	Ø8 x 110	✓	SW 13	60	152	76	200	100	60																		
	TFE08120	Ø8 x 120	✓	SW 13	70	152	76	200	100	70																		
	TFE08140	Ø8 x 140	✓	SW 13	75	152	76	200	100	75																		

*Ø5 Assessed only for use in concrete and in precast prestressed hollow core slabs for redundant non-structural systems

General Installation parameters										Standard Installation depth ($h_{ef, std}$)								Reduced Installation depth ($h_{ef, red}$)										
Family	Code	Size (Letter)	Assessed	Drill bit diameter	Fixture clearance hole	Spanner	Maximum torque	Minimum allowable spacing	Minimum allowable edge distance	Minimum concrete thickness	Depth of drill hole	Installation depth	Effective anchorage depth	Thickness of fixture	Critical spacing (concrete cone)	Critical edge distance (cone)	Critical spacing (splitting)	Critical edge distance (splitting)	Minimum concrete thickness	Depth of drill hole	Installation depth	Effective anchorage depth	Thickness of fixture	Critical spacing (concrete cone)	Critical edge distance (cone)	Critical spacing (splitting)	Critical edge distance (splitting)	
[--]	[--]	[--]	ETA	d_0	d_f	SW/Tx	T_{inst}	S_{min}	C_{min}	h_{min}	h_1	h_{nom}	h_{ef}	t_{fix}	$S_{cr,N}$	$C_{cr,N}$	$S_{cr,sp}$	$C_{cr,sp}$	h_{min}	h_1	h_{nom}	h_{ef}	t_{fix}	$S_{cr,N}$	$C_{cr,N}$	$S_{cr,sp}$	$C_{cr,sp}$	
				[mm]	[mm]	[--]	[Nm]	[mm]	[mm]	[mm]	[mm]	[mm]	[mm]	[mm]	[mm]	[mm]	[mm]	[mm]	[mm]	[mm]	[mm]	[mm]	[mm]	[mm]	[mm]	[mm]	[mm]	[mm]
TFE	TFE10060	Ø10 x 60	✓	10	12,5 - 14	SW 15	30	50	40	--	--	--	--	--	--	--	--	--	100	65	55	41,5	5	125	63	140	70	
	TFE10070	Ø10 x 70	✓			15																						
	TFE10080	Ø10 x 80	✓			25																						
	TFE10090	Ø10 x 90	✓			35																						
	TFE10100	Ø10 x 100	✓			45																						
	TFE10120	Ø10 x 120	✓			65																						
	TFE10140	Ø10 x 140	✓			85																						
	TFE10160	Ø10 x 160	✓			105																						
	TFE10180	Ø10 x 180	✓			125																						
	TFE12080	Ø12 x 80	✓	12	14,8 - 16	SW 18	50	75	45	--	--	--	--	--	--	--	--	--	120	90	75	58,0	5	174	87	190	95	
	TFE12090	Ø12 x 90	✓			15																						
	TFE12100	Ø12 x 100	✓			25																						
	TFE12110	Ø12 x 110	✓			35																						
	TFE12130	Ø12 x 130	✓			55																						
	TFE12150	Ø12 x 150	✓			75																						
	TFE14080	Ø14 x 80	✓	14	16,9 - 18	SW 21	70	80	50	--	--	--	--	--	--	--	--	--	120	90	75	58,0	5	174	87	190	95	
	TFE14100	Ø14 x 100	✓			15																						
	TFE14110	Ø14 x 110	✓			25																						
	TFE14120	Ø14 x 120	✓			35																						
	TFE14130	Ø14 x 130	✓			45																						
TFE14140	Ø14 x 140	✓	55																									
TFE14160	Ø14 x 160	✓	85																									
TFE16100	Ø16 x 100	✓	16	18,9 - 20	SW24	80	80	50	--	--	--	--	--	--	--	--	--	115	100	80	58	20	174	87	180	90		
TFE16150	Ø16 x 150	✓			70																							
TFE18100	Ø18 x 100	✓	18	20,9 - 22	SW 24	90	90	55	--	--	--	--	--	--	--	--	--	--	140	110	90	69,5	10	209	105	230	115	
TFE18130	Ø18 x 130	✓			40																							
TFE18160	Ø18 x 160	✓			70																							
TFE18180	Ø18 x 180	✓			90																							
TFE18200	Ø18 x 200	✓			110																							
					110																							

General Installation parameters										Standard Installation depth ($h_{ef, std}$)								Reduced Installation depth ($h_{ef, red}$)										
Family	Code	Size (Letter)	Assessed	Drill bit diameter	Fixture clearance hole	Spanner	Maximum torque	Minimum allowable spacing	Minimum allowable edge distance	Minimum concrete thickness	Depth of drill hole	Installation depth	Effective anchorage depth	Thickness of fixture	Critical spacing (concrete cone)	Critical edge distance (cone)	Critical spacing (splitting)	Critical edge distance (splitting)	Minimum concrete thickness	Depth of drill hole	Installation depth	Effective anchorage depth	Thickness of fixture	Critical spacing (concrete cone)	Critical edge distance (cone)	Critical spacing (splitting)	Critical edge distance (splitting)	
[--]	[--]	[--]	ETA	d_0	d_f	SW/Tx	T_{inst}	S_{min}	C_{min}	h_{min}	h_1	h_{nom}	h_{ef}	t_{fix}	$S_{cr,N}$	$C_{cr,N}$	$S_{cr,sp}$	$C_{cr,sp}$	h_{min}	h_1	h_{nom}	h_{ef}	t_{fix}	$S_{cr,N}$	$C_{cr,N}$	$S_{cr,sp}$	$C_{cr,sp}$	
				[mm]	[mm]	[--]	[Nm]	[mm]	[mm]	[mm]	[mm]	[mm]	[mm]	[mm]	[mm]	[mm]	[mm]	[mm]	[mm]	[mm]	[mm]	[mm]	[mm]	[mm]	[mm]	[mm]	[mm]	[mm]
TFA	TFA05040	Ø5 x 40(A)	✓*	5	6,5 - 8	TX25	8	35	35	80	55	45	35,0	--	105	53	105	53	80	45	35	26,5	5	80	40	80	40	
	TFA05060	Ø5 x 60(B)	✓*			25																						
	TFA05080	Ø5 x 80(D)	✓*			45																						
	TFA05100	Ø5 x 100(E)	✓*			65																						
	TFA06045	Ø6 x 45	✓	6	7,5 - 9	TX30	10	35	35	--	100	65	55	43,0	--	129	65	170	85	100	45	35	26,0	10	78	39	90	45
	TFA06050	Ø6 x 50	✓			15																						
	TFA06060	Ø6 x 60	✓			25																						
	TFA06080	Ø6 x 80	✓			45																						
	TFA06100	Ø6 x 100	✓			65																						
	TFA06120	Ø6 x 120	✓			85																						
	TFA06140	Ø6 x 140	✓	105																								
	TFA08060	Ø8 x 60	✓	8	10,5 - 12	TX45	20	35	35	--	100	75	65	50,5	--	152	76	200	100	100	60	50	37,5	10	113	57	130	65
	TFA08080	Ø8 x 80	✓			15																						
	TFA08100	Ø8 x 100	✓			35																						
	TFA08120	Ø8 x 120	✓			55																						
	TFA10100	Ø10 x 100	✓	10	12,5 - 14	TX50	30	50	40	135	95	85	67,0	15	201	101	210	105	100	65	55	41,5	45	125	63	140	70	
TFA10120	Ø10 x 120	✓	35			65																						
TFT	TFT06040	Ø6 x 40	✓	6	7,5 - 9	TX30	10	35	35	--	100	65	55	43,0	--	129	65	170	85	100	45	35	26,0	5	78	39	90	45
	TFT06050	Ø6 x 50	✓			15																						
	TFT06060	Ø6 x 60	✓			25																						
TFP	TFP05040	Ø5 x 40(A)	✓*	5	6,5 - 8	TX30	8	35	35	--	80	55	45	35,0	--	105	53	105	53	80	45	35	26,5	5	80	40	80	40
	TFP05060	Ø5 x 60(B)	✓*			25																						
	TFP06040	Ø6 x 40	✓	6	7,5 - 9	TX40	10	35	35	--	100	65	55	43,0	--	129	65	170	85	100	45	35	26,0	5	78	39	90	45
	TFP06050	Ø6 x 50	✓			15																						
	TFP06060	Ø6 x 60	✓			25																						
	TFP06080	Ø6 x 80	✓			45																						
	TFP06100	Ø6 x 100	✓			65																						
TFP08060	Ø8 x 60	✓	8	10,5 - 12	TX45	20	35	35	--	100	75	65	50,5	--	152	76	200	100	100	60	50	37,5	10	113	57	130	65	
TFP08080	Ø8 x 80	✓			30																							
TFN	TFN14080	Ø14 x 80	✓	14	16,9 - 18	SW 24	70	80	50	--	--	--	--	--	--	--	--	--	120	90	75	58,0	5	174	87	190	95	

*Ø5 Assessed only for use in concrete and in precast prestressed hollow core slabs for redundant non-structural systems

General Installation parameters										Standard Installation depth ($h_{ef, std}$)									Reduced Installation depth ($h_{ef, red}$)								
Family	Code	Size (Letter)	Assessed	Drill bit diameter	Fixture clearance hole	Spanner	Maximum torque	Minimum allowable spacing	Minimum allowable edge distance	Minimum concrete thickness	Depth of drill hole	Installation depth	Effective anchorage depth	Thickness of fixture	Critical spacing (concrete cone)	Critical edge distance (cone)	Critical spacing (splitting)	Critical edge distance (splitting)	Minimum concrete thickness	Depth of drill hole	Installation depth	Effective anchorage depth	Thickness of fixture	Critical spacing (concrete cone)	Critical edge distance (cone)	Critical spacing (splitting)	Critical edge distance (splitting)
				d_0	d_f					SW/Tx	T_{inst}	S_{min}	C_{min}	h_{min}	h_1	h_{nom}	h_{ef}	t_{fix}	$S_{cr,N}$	$C_{cr,N}$	$S_{cr,sp}$	$C_{cr,sp}$	h_{min}	h_1	h_{nom}	h_{ef}	t_{fix}
[--]	[--]	[--]	ETA	[mm]	[mm]	[--]	[Nm]	[mm]	[mm]	[mm]	[mm]	[mm]	[mm]	[mm]	[mm]	[mm]	[mm]	[mm]	[mm]	[mm]	[mm]	[mm]	[mm]	[mm]	[mm]	[mm]	[mm]
TFF	TFF05035S	Ø5 x 35 (M6)	✓*	5	--	SW10	8	35	35	--	--	--	--	--	--	--	--	--	80	45	35	26,5	--	80	40	80	40
	TFF06035	Ø6 x 35 (M8-M10)	✓	6	--	SW 13	10	35	35	--	--	--	--	--	--	--	--	--	100	45	35	26,0	--	78	39	90	45
	TFF06040	Ø6 x 40 (M8-M10)	✓			SW 13				--	--	--	--	--	100	45	35	26,0	--	78	39	90	45				
	TFF06055	Ø6 x 55 (M8-M10)	✓			SW 13				100	65	55	43,0	--	129	65	170	85	--	--	--	--	--				
	TFF08050T	Ø8 x 50 (M10)	✓	8	--	SW 13	20	35	35	--	--	--	--	--	--	--	--	--	100	60	50	37,5	--	113	57	130	65
	TFF08050W	Ø8 x 50 (M12)	✓			SW 17				--	--	--	--	--	100	60	50	37,5	--	113	57	130	65				
TFM	TFM06035	Ø6 x 35 (M8)	✓	6	--	SW 13	10	35	35	--	--	--	--	--	--	--	--	--	100	65	55	26,0	--	78	39	90	45
	TFM06055	Ø6 x 55 (M10)	✓			SW 13				100	65	55	43,0	--	129	65	170	85	--	--	--	--	--				
TFS	TFS06100	Ø6 x 100 (M8)	✓	6	7,5 - 9	SW 5	10	35	35	100	65	55	43,0	31	129	65	170	85	100	45	35	26,0	51	78	39	90	45
	TFS06120	Ø6 x 120 (M8)	✓			SW 5								51									71				
	TFS08110	Ø8 x 110 (M10)	✓	8	10,5 - 12	SW 7	20	35	35	100	75	65	50,5	29	152	76	200	100	100	60	50	37,5	44	113	57	130	65
	TFS08130	Ø8 x 130 (M10)	✓			SW 7								49									64				
	TFS10120	Ø10 x 120 (M12)	✓	10	12,5 - 14	SW 8	30	50	40	120	85	75	58,5	16	176	88	190	95	100	65	55	41,5	46	125	63	140	70
	TFS10140	Ø10 x 140 (M12)	✓			SW 8								36									66				

4. INSTALLATION PARAMETERS (HOLLOW CORE SLABS) [Installation depth reduced/intermediate/standard]

General Installation parameters											Installation depth ($h_{ef1}/ h_{ef2}/ h_{ef3}$)							
Family	Code	Size (Letter)	Assessed	Drill bit diameter	Fixture clearance hole	Spanner	Maximum torque	Minimum allowable spacing	Minimum allowable edge distance	Bottom flange thickness	Depth of drill hole	Installation depth	Effective anchorage depth	Thickness of fixture	Critical spacing (concrete cone)	Critical edge distance (cone)	Critical spacing (splitting)	Critical edge distance (splitting)
[-]	[-]	[-]	ETA	d_0	d_f	SW/Tx	T_{inst}	S_{min}	C_{min}	d_b	h_1	h_{nom}	h_{ef}	t_{fix}	$S_{cr,N}$	$C_{cr,N}$	$S_{cr,sp}$	$C_{cr,sp}$
				[mm]	[mm]	[-]	[Nm]	[mm]	[mm]	[mm]	[mm]	[mm]	[mm]	[mm]	[mm]	[mm]	[mm]	[mm]
TFE	TFE05040	Ø5 x 40(A)	✓*	5	6,5 - 8	SW 8	8	35	35	25/30/40	30/40/45	30/40/45	20/22/26,5	10/--/--	60/66/80	30/33/40	80	80
	TFE05050	Ø5 x 50(A)	✓*			20/10/5												
	TFE05060	Ø5 x 60(B)	✓*			30/20/15												
	TFE05080	Ø5 x 80(D)	✓*			50/40/35												
	TFE05100	Ø5 x 100(E)	✓*			70/60/55												
	TFE06035	Ø6 x 35	✓	6	7,5 - 9	SW 10	10	35	35	25/30/40	30/40/45	30/40/45	20/22/26	5/--/--	60/66/78	30/33/39	90	45
	TFE06040	Ø6 x 40	✓			10/--/--												
	TFE06045	Ø6 x 45	✓			15/5/--												
	TFE06050	Ø6 x 50	✓			20/10/5												
	TFE06060	Ø6 x 60	✓			30/20/15												
	TFE06070	Ø6 x 70	✓			40/30/25												
	TFE06080	Ø6 x 80	✓			50/40/35												
	TFE06100	Ø6 x 100	✓			70/60/55												
	TFE06120	Ø6 x 120	✓			90/80/75												
TFE06140	Ø6 x 140	✓	110/100/95															
TFA	TFA05040	Ø5 x 40(A)	✓*	5	6,5 - 8	TX25	8	35	35	25/30/40	30/40/45	30/40/45	20/22/26,5	10/--/--	60/66/80	30/33/40	80	80
	TFA05060	Ø5 x 60(B)	✓*			30/20/15												
	TFA05080	Ø5 x 80(D)	✓*			50/40/35												
	TFA05100	Ø5 x 100(E)	✓*			70/60/55												
	TFA06045	Ø6 x 45	✓	6	7,5 - 9	TX30	10	35	35	25/30/40	30/40/45	30/40/45	20/22/26	15/5/--	60/66/78	30/33/39	90	45
	TFA06050	Ø6 x 50	✓			20/10/5												
	TFA06060	Ø6 x 60	✓			30/20/15												
	TFA06080	Ø6 x 80	✓			50/40/35												
	TFA06100	Ø6 x 100	✓			70/60/55												
	TFA06120	Ø6 x 120	✓			90/80/75												
	TFA06140	Ø6 x 140	✓			110/100/95												

*Ø5 Assessed only for use in concrete and in precast prestressed hollow core slabs for redundant non-structural systems

General Installation parameters										Installation depth (h _{ef1} / h _{ef2} / h _{ef3})								
Family	Code	Size (Letter)	Assessed	Drill bit diameter	Fixture clearance hole	Spanner	Maximum torque	Minimum allowable spacing	Minimum allowable edge distance	Bottom flange thickness	Depth of drill hole	Installation depth	Effective anchorage depth	Thickness of fixture	Critical spacing (concrete cone)	Critical edge distance (cone)	Critical spacing (splitting)	Critical edge distance (splitting)
				d ₀	d _f													
[--]	[--]	[--]	ETA	[mm]	[mm]	[--]	[Nm]	[mm]	[mm]	[mm]	[mm]	[mm]	[mm]	[mm]	[mm]	[mm]	[mm]	[mm]
TFT	TFT06040	Ø6 x 40	✓	6	7,5 - 9	TX30	10	35	35	25/30/40	30/40/45	30/40/45	20/22/26	10/--/--	60/66/78	30/33/39	90	45
	TFT06050	Ø6 x 50	✓			TX30								20/10/5				
	TFT06060	Ø6 x 60	✓			TX30								30/20/15				
TFP	TFP05040	Ø5 x 40(A)	✓*	5	6,5 - 8	TX30	8	35	35	25/30/40	30/40/45	30/40/45	20/22/26,5	10/--/--	60/66/80	30/33/40	80	80
	TFP05060	Ø5 x 60(B)	✓*			TX30								30/20/15				
	TFP06040	Ø6 x 40	✓	6	7,5 - 9	TX40	10	35	35	25/30/40	30/40/45	30/40/45	20/22/26	10/--/--	60/66/78	30/33/39	90	45
	TFP06050	Ø6 x 50	✓			TX40								20/10/5				
	TFP06060	Ø6 x 60	✓			TX40								30/20/15				
	TFP06080	Ø6 x 80	✓			TX40								50/40/35				
	TFP06100	Ø6 x 100	✓			TX40								70/60/55				
TFF	TFF05035S	Ø5 x 35 (M6)	✓*	5	6,5 - 8	SW10	8	35	35	25/30/40	30/40/45	30/40/45	20/22/26	--/--/--	60/66/80	30/33/40	80	80
	TFF06035	Ø6 x 35 (M8-M10)	✓	6	7,5 - 9	SW 13	10	35	35	25/30/40	30/40/45	30/40/45	20/22/26	--/--/--	60/66/78	30/33/39	90	45
	TFF06040	Ø6 x 40 (M8-M10)	✓															
	TFF06055	Ø6 x 55 (M8-M10)	✓															
TFM	TFM06035	Ø6 x 35 (M8)	✓	6	7,5 - 9	SW 13	10	35	35	25/30/40	30/40/45	30/40/45	20/22/26	--/--/--	60/66/78	30/33/39	90	45
	TFM06055	Ø6 x 55 (M10)	✓															
TFS	TFS06100	Ø6 x 100 (M8)	✓	6	7,5 - 9	SW 5	10	35	35	25/30/40	30/40/45	30/40/45	20/22/26	56/46/41	60/66/78	30/33/39	90	45
		TFS06120	Ø6 x 120 (M8)											✓				

*Ø5 Assessed only for use in concrete and in precast prestressed hollow core slabs for redundant non-structural systems

5. INSTALLATION PROCEDURE

5.1. CONCRETE AND HOLLOW CORE SLAB INSTALLATION

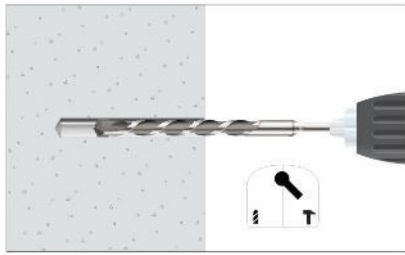

1. DRILLING

Check the concrete is well compacted and without significant porosity. Suitable for dry, wet and flooded holes. Use drill in hammer mode. Drill according to specified depths in previous tables.



2. BLOW AND CLEAN

Clean the hole from dust and concrete remains. Use blow pump and brush.

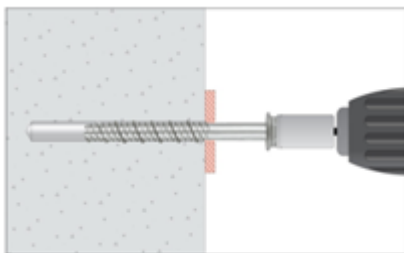

3. INSTALL

Select a powered impact wrench or a torque wrench that does not exceed the maximum torque indicated in previous tables. Attach an appropriate size hex socket to the wrench. Mount the screw anchor head in the socket.

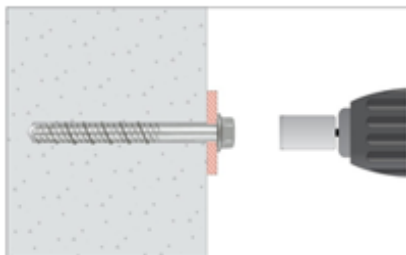

4. APPLY THE TORQUE

Drive the anchor with an impact driver or a torque wrench through the fixture and into the hole until the anchor head washer comes in contact with the fixture. The anchor must be snug after installation. Do not spin the hex socket off the anchor to disengage.

6. RESISTANCES (CONCRETE)

Resistances in concrete class C20/25 for an isolated anchor without spacing or concrete edge distance effects are indicated in the following table:

Values underlined and in italics show Steel failure, **bold** values concrete failure and other indicate pull out failure.
1 kN ≈ 100 kg

6.1 CHARACTERISTIC RESISTANCE (STRUCTURAL APPLICATION) [kN]

General Parameter				Non-cracked concrete				Cracked concrete											
Family	Code	Size	ETA Assessed	Tension $N_{Rk, ucr}$		Shear $V_{Rk, ucr}$		Tension $N_{Rk, ucr}$		Shear $V_{Rk, ucr}$									
				($h_{ef, std}$)	($h_{ef, red}$)	($h_{ef, std}$)	($h_{ef, red}$)	($h_{ef, std}$)	($h_{ef, red}$)	($h_{ef, std}$)	($h_{ef, red}$)								
TFE	TFE05040	Ø5 x 40	✓*	--	6,71	--	6,71	--	4,70	--	4,70								
	TFE05050	Ø5 x 50	✓*	10,19	6,71	<u><i>8,19</i></u>	6,71	7,13	4,70	7,13	4,70								
	TFE05060	Ø5 x 60	✓*																
	TFE05080	Ø5 x 80	✓*																
	TFE05100	Ø5 x 100	✓*																
	TFE06035	Ø6 x 35	✓	--	5,00	--	<u><i>12,53</i></u>	--	4,57	--	9,36								
	TFE06040	Ø6 x 40	✓																
	TFE06045	Ø6 x 45	✓																
	TFE06050	Ø6 x 50	✓																
	TFE06060	Ø6 x 60	✓	13,87	5,00	<u><i>12,53</i></u>	<u><i>12,53</i></u>	9,71	4,57	11,17	9,36								
	TFE06070	Ø6 x 70	✓																
	TFE06080	Ø6 x 80	✓																
	TFE06100	Ø6 x 100	✓																
	TFE06120	Ø6 x 120	✓																
	TFE08055	Ø8 x 55	✓									--	11,30	--	<u><i>19,57</i></u>	--	7,91	--	14,23
	TFE08060	Ø8 x 60	✓																
	TFE08070	Ø8 x 70	✓									17,65	11,30	<u><i>19,57</i></u>	<u><i>19,57</i></u>	12,36	7,91	15,69	14,23
	TFE08075	Ø8 x 75	✓																
	TFE08080	Ø8 x 80	✓																
	TFE08090	Ø8 x 90	✓																
	TFE08100	Ø8 x 100	✓																
	TFE08110	Ø8 x 110	✓																
	TFE08120	Ø8 x 120	✓																
	TFE08140	Ø8 x 140	✓																
	TFE10060	Ø10 x 60	✓	--	13,15	--	25,65	--	9,21	--	17,95								
	TFE10070	Ø10 x 70	✓																
	TFE10080	Ø10 x 80	✓																
	TFE10090	Ø10 x 90	✓																
	TFE10100	Ø10 x 100	✓	26,98	13,15	<u><i>27,40</i></u>	25,65	18,89	9,21	<u><i>27,40</i></u>	17,95								
	TFE10120	Ø10 x 120	✓																
	TFE10140	Ø10 x 140	✓																
	TFE10160	Ø10 x 160	✓																
	TFE10180	Ø10 x 180	✓																
	TFE12080	Ø12 x 80	✓									--	21,73	--	<u><i>37,24</i></u>	--	15,21	--	35,44
	TFE12090	Ø12 x 90	✓																
	TFE12100	Ø12 x 100	✓	--	37,54	21,73	<u><i>37,24</i></u>	<u><i>37,24</i></u>	26,27	15,21	<u><i>37,24</i></u>	35,44							
	TFE12110	Ø12 x 110	✓																
	TFE12130	Ø12 x 130	✓																
	TFE12150	Ø12 x 150	✓																
	TFE14080	Ø14 x 80	✓	--	21,73	--	<u><i>52,72</i></u>	--	15,21	--	38,79								
TFE14100	Ø14 x 100	✓																	
TFE14110	Ø14 x 110	✓																	
TFE14120	Ø14 x 120	✓																	
TFE14130	Ø14 x 130	✓	43,41	21,73	<u><i>52,72</i></u>	<u><i>52,72</i></u>	30,39	15,21	<u><i>52,72</i></u>	38,79									
TFE14140	Ø14 x 140	✓																	
TFE14160	Ø14 x 160	✓																	
TFE16100	Ø16 x 100	✓									--	43,41	21,73	<u><i>57,97</i></u>	46,50	30,39	15,21	<u><i>52,72</i></u>	32,55
TFE16150	Ø16 x 150	✓																	
TFE18100	Ø18 x 100	✓	--	28,50	--	75,82	--	19,95	--	53,07									
TFE18130	Ø18 x 130	✓																	
TFE18160	Ø18 x 160	✓	58,31	28,50	<u><i>80,78</i></u>	75,82	40,82	19,95	<u><i>80,78</i></u>	53,07									
TFE18180	Ø18 x 180	✓																	
TFE18200	Ø18 x 200	✓																	

General Parameter				Non-cracked concrete				Cracked concrete			
Family	Code	Size	ETA Assessed	Tension $N_{Rk, ucr}$		Shear $V_{Rk, ucr}$		Tension $N_{Rk, ucr}$		Shear $V_{Rk, ucr}$	
				($h_{ef, std}$)	($h_{ef, red}$)	($h_{ef, std}$)	($h_{ef, red}$)	($h_{ef, std}$)	($h_{ef, red}$)	($h_{ef, std}$)	($h_{ef, red}$)
TFA	TFA05040	Ø5 x 40	✓*	--	6,71	--	6,71	--	4,70	--	4,70
	TFA05060	Ø5 x 60	✓*	10,19	6,71	<u>8,19</u>	6,71	7,13	4,70	7,13	4,70
	TFA05080	Ø5 x 80	✓*								
	TFA05100	Ø5 x 100	✓*								
	TFA06045	Ø6 x 45	✓	--	5,00	--	<u>12,53</u>	--	4,57	--	9,36
	TFA06050	Ø6 x 50	✓	--		--		--			
	TFA06060	Ø6 x 60	✓	13,87	5,00	<u>12,53</u>	<u>12,53</u>	9,71	4,57	11,17	9,36
	TFA06080	Ø6 x 80	✓								
	TFA06100	Ø6 x 100	✓								
	TFA06120	Ø6 x 120	✓								
	TFA06140	Ø6 x 140	✓								
	TFA08060	Ø8 x 60	✓	--	11,30	--	<u>19,57</u>	--	7,91	--	14,23
	TFA08080	Ø8 x 80	✓	17,65	11,30	<u>19,57</u>	<u>19,57</u>	12,36	7,91	15,69	14,23
	TFA08100	Ø8 x 100	✓								
TFA08120	Ø8 x 120	✓									
TFA10100	Ø10 x 100	✓	26,98	13,15	<u>27,40</u>	25,65	18,89	9,21	<u>27,40</u>	17,95	
TFA10120	Ø10 x 120	✓									
TFT	TFT06040	Ø6 x 40	✓	--	5,00	--	<u>12,53</u>	--	4,57	--	9,36
	TFT06050	Ø6 x 50	✓	--		--		--			
	TFT06060	Ø6 x 60	✓	13,87	5,00	<u>12,53</u>	<u>12,53</u>	9,71	4,57	11,17	9,36
TFP	TFP05040	Ø5 x 40	✓*	--	6,71	--	6,71	--	4,70	--	4,70
	TFP05060	Ø5 x 60	✓*	10,19	6,71	<u>8,19</u>	6,71	7,13	4,70	7,13	4,70
	TFP06040	Ø6 x 40	✓	--	5,00	--	<u>12,53</u>	9,71	4,57	--	9,36
	TFP06050	Ø6 x 50	✓	--		--				--	
	TFP06060	Ø6 x 60	✓	13,87	5,00	<u>12,53</u>	<u>12,53</u>	9,71	4,57	11,17	9,36
	TFP06080	Ø6 x 80	✓								
	TFP06100	Ø6 x 100	✓								
	TFP08060	Ø8 x 60	✓	--	11,30	--	<u>19,57</u>	--	7,91	--	14,23
TFP08080	Ø8 x 80	✓	17,65	11,30	<u>19,57</u>	<u>19,57</u>	12,36	7,91	15,69	14,23	
TFN	TFN14080	Ø14 x 80	✓	--	21,73	--	<u>52,72</u>	--	15,21	--	38,79
TFF	TFF05035S	Ø5 x 35 (M6)	✓*	--	6,71	--	--	--	4,70	--	--
	TFF06035	Ø6 x 35 (M8-M10)	✓	--	5,00	--	--	--	4,57	--	--
	TFF06040	Ø6 x 40 (M8-M10)	✓	--		--	--	--			
	TFF06055	Ø6 x 55 (M8-M10)	✓	13,87	--	--	--	9,71	--	--	--
	TFF08050T	Ø8 x 50 (M10)	✓	--	11,30	--	--	--	7,91	--	--
	TFF08050W	Ø8 x 50 (M12)	✓	--		--	--	--			
TFM	TFM06035	Ø6 x 35 (M8)	✓	--	5,00	--	--	--	4,57	--	--
	TFM06055	Ø6 x 55 (M10)	✓	13,87	--	--	--	9,71	--	--	--
TFS	TFS06100	Ø6 x 100 (M8)	✓	13,87	5,00	<u>12,53</u>	<u>12,53</u>	9,71	4,57	11,17	9,36
	TFS06120	Ø6 x 120 (M8)	✓								
	TFS08110	Ø8 x 110 (M10)	✓	17,65	11,30	<u>19,57</u>	<u>19,57</u>	12,36	7,91	15,69	14,23
	TFS08130	Ø8 x 130 (M10)	✓								
	TFS10120	Ø10 x 120 (M12)	✓								
	TFS10140	Ø10 x 140 (M12)	✓	22,01	13,15	<u>27,40</u>	25,65	15,41	9,21	20,34	17,95

*Ø5 Assessed only for use in concrete and in precast prestressed hollow core slabs for redundant non-structural systems

6.2 DESIGN RESISTANCE (STRUCTURAL APPLICATION) [kN]

General Parameter				Non-cracked concrete				Cracked concrete							
Family	Code	Size	ETA Assessed	Tension $N_{Rd, ucr}$		Shear $V_{Rd, ucr}$		Tension $N_{Rd, cr}$		Shear $V_{Rd, cr}$					
				($h_{ef, std}$)	($h_{ef, red}$)	($h_{ef, std}$)	($h_{ef, red}$)	($h_{ef, std}$)	($h_{ef, red}$)	($h_{ef, std}$)	($h_{ef, red}$)				
TFE	TFE05040	Ø5 x 40	✓*	--	4,47	--	4,47	--	3,13	--	3,13				
	TFE05050	Ø5 x 50	✓*	6,79	4,47	<u>5,46</u>	4,47	4,75	3,13	4,75	3,13				
	TFE05060	Ø5 x 60	✓*												
	TFE05080	Ø5 x 80	✓*												
	TFE05100	Ø5 x 100	✓*												
	TFE06035	Ø6 x 35	✓	--	2,78	--	<u>8,35</u>	--	2,54	--	6,24				
	TFE06040	Ø6 x 40	✓	--		--		--							
	TFE06045	Ø6 x 45	✓	--		--		--							
	TFE06050	Ø6 x 50	✓	--		--		--							
	TFE06060	Ø6 x 60	✓	9,25	2,78	<u>8,35</u>	<u>8,35</u>	6,47	2,54	7,44	6,24				
	TFE06070	Ø6 x 70	✓												
	TFE06080	Ø6 x 80	✓												
	TFE06100	Ø6 x 100	✓												
	TFE06120	Ø6 x 120	✓	11,77	6,28	<u>13,05</u>	<u>13,05</u>	8,24	4,39	10,46	9,49				
	TFE08055	Ø8 x 55	✓												
	TFE08060	Ø8 x 60	✓												
	TFE08070	Ø8 x 70	✓												
	TFE08075	Ø8 x 75	✓	11,77	6,28	<u>13,05</u>	<u>13,05</u>	8,24	4,39	10,46	9,49				
	TFE08080	Ø8 x 80	✓												
	TFE08090	Ø8 x 90	✓												
	TFE08100	Ø8 x 100	✓												
	TFE08110	Ø8 x 110	✓	17,99	8,77	<u>18,27</u>	17,10	12,59	6,14	<u>18,27</u>	11,97				
	TFE08120	Ø8 x 120	✓												
	TFE08140	Ø8 x 140	✓												
	TFE10060	Ø10 x 60	✓												
	TFE10070	Ø10 x 70	✓	--	8,77	--	17,10	--	6,14	--	11,97				
	TFE10080	Ø10 x 80	✓	--		--		--							
	TFE10090	Ø10 x 90	✓	17,99		8,77		<u>18,27</u>		17,10		12,59	6,14	<u>18,27</u>	11,97
	TFE10100	Ø10 x 100	✓												
	TFE10120	Ø10 x 120	✓												
	TFE10140	Ø10 x 140	✓												
	TFE10160	Ø10 x 160	✓	25,02	14,49	<u>24,83</u>	<u>24,83</u>	17,52	10,14	<u>24,83</u>	23,63				
TFE10180	Ø10 x 180	✓													
TFE12080	Ø12 x 80	✓													
TFE12090	Ø12 x 90	✓													
TFE12090	Ø12 x 90	✓	--	14,49	--	<u>24,83</u>	--	10,14	--	23,63					
TFE12100	Ø12 x 100	✓	--		--		--								
TFE12110	Ø12 x 110	✓	25,02		14,49		<u>24,83</u>		<u>24,83</u>		17,52	10,14	<u>24,83</u>	23,63	
TFE12130	Ø12 x 130	✓													
TFE12150	Ø12 x 150	✓													
TFE14080	Ø14 x 80	✓													
TFE14100	Ø14 x 100	✓	--	21,73	--	<u>52,72</u>	--	15,21	--	38,79					
TFE14110	Ø14 x 110	✓	--		--		--								
TFE14120	Ø14 x 120	✓	43,41		21,73		<u>52,72</u>		<u>52,72</u>		30,39	15,21	<u>52,72</u>	38,79	
TFE14130	Ø14 x 130	✓													
TFE14140	Ø14 x 140	✓													
TFE14160	Ø14 x 160	✓													
TFE16100	Ø16 x 100	✓	--	--	--	--	20,26	10,14	<u>38,65</u>	21,70					
TFE16150	Ø16 x 150	✓	28,94	14,49	<u>38,65</u>	31,00									
TFE18100	Ø18 x 100	✓	--	19,00	--	50,54	--	13,30	--	35,38					
TFE18130	Ø18 x 130	✓	--		--		--								
TFE18160	Ø18 x 160	✓	38,87	19,00	<u>53,85</u>	50,54	27,21	13,30	<u>53,85</u>	35,38					
TFE18180	Ø18 x 180	✓													
TFE18200	Ø18 x 200	✓													

General Parameter				Non-cracked concrete				Cracked concrete			
Family	Code	Size	ETA Assessed	Tension $N_{Rd, ucr}$		Shear $V_{Rd, ucr}$		Tension $N_{Rd, cr}$		Shear $V_{Rd, cr}$	
				($h_{ef, std}$)	($h_{ef, red}$)	($h_{ef, std}$)	($h_{ef, red}$)	($h_{ef, std}$)	($h_{ef, red}$)	($h_{ef, std}$)	($h_{ef, red}$)
TFA	TFA05040	Ø5 x 40	✓*	--	4,47	--	4,47	--	3,13	--	3,13
	TFA05060	Ø5 x 60	✓*	6,79	4,47	<u>5,46</u>	4,47	4,75	3,13	4,75	3,13
	TFA05080	Ø5 x 80	✓*								
	TFA05100	Ø5 x 100	✓*								
	TFA06045	Ø6 x 45	✓	--	2,78	--	<u>8,35</u>	--	2,54	--	6,24
	TFA06050	Ø6 x 50	✓								
	TFA06060	Ø6 x 60	✓	9,25	2,78	<u>8,35</u>	<u>8,35</u>	6,47	2,54	7,44	6,24
	TFA06080	Ø6 x 80	✓								
	TFA06100	Ø6 x 100	✓								
	TFA06120	Ø6 x 120	✓								
	TFA06140	Ø6 x 140	✓								
	TFA08060	Ø8 x 60	✓	--	6,28	--	<u>13,05</u>	--	4,39	--	9,49
	TFA08080	Ø8 x 80	✓	11,77	6,28	<u>13,05</u>	<u>13,05</u>	8,24	4,39	10,46	9,49
	TFA08100	Ø8 x 100	✓								
TFA08120	Ø8 x 120	✓									
TFA10100	Ø10 x 100	✓	17,99	8,77	<u>18,27</u>	17,10	12,59	6,14	<u>18,27</u>	11,97	
TFA10120	Ø10 x 120	✓									
TFT	TFT06040	Ø6 x 40	✓	--	2,78	--	<u>8,35</u>	--	2,54	--	6,24
	TFT06050	Ø6 x 50	✓								
	TFT06060	Ø6 x 60	✓	9,25	2,78	<u>8,35</u>	<u>8,35</u>	6,47	2,54	7,44	6,24
TFP	TFP05040	Ø5 x 40	✓*	--	4,47	--	4,47	--	3,13	--	3,13
	TFP05060	Ø5 x 60	✓*	6,79	4,47	<u>5,46</u>	4,47	4,75	3,13	4,75	3,13
	TFP06040	Ø6 x 40	✓	--	2,78	--	<u>8,35</u>	--	2,54	--	6,24
	TFP06050	Ø6 x 50	✓								
	TFP06060	Ø6 x 60	✓	9,25	2,78	<u>8,35</u>	<u>8,35</u>	6,47	2,54	7,44	6,24
	TFP06080	Ø6 x 80	✓								
	TFP06100	Ø6 x 100	✓								
	TFP08060	Ø8 x 60	✓	--	6,28	--	<u>13,05</u>	--	4,39	--	9,49
TFP08080	Ø8 x 80	✓	11,77	6,28	<u>13,05</u>	<u>13,05</u>	8,24	4,39	10,46	9,49	
TFN	TFN14080	Ø14 x 80	✓	--	14,49	--	35,15	--	10,14	--	25,86
TFF	TFF05035S	Ø5 x 35 (M6)	✓*	--	4,47	--	--	--	3,13	--	--
	TFF06035	Ø6 x 35 (M8-M10)	✓	--	2,78	--	--	--	2,54	--	--
	TFF06040	Ø6 x 40 (M8-M10)	✓								
	TFF06055	Ø6 x 55 (M8-M10)	✓	9,25	--	--	--	6,47	--	--	--
	TFF08050T	Ø8 x 50 (M10)	✓	--	6,28	--	--	--	4,39	--	--
	TFF08050W	Ø8 x 50 (M12)	✓								
TFM	TFM06035	Ø6 x 35 (M8)	✓	--	2,78	--	--	--	2,54	--	--
	TFM06055	Ø6 x 55 (M10)	✓	9,25	--	--	--	6,47	--	--	--
TFS	TFS06100	Ø6 x 100 (M8)	✓	9,25	2,78	<u>8,35</u>	<u>8,35</u>	6,47	2,54	7,44	6,24
	TFS06120	Ø6 x 120 (M8)	✓								
	TFS08110	Ø8 x 110 (M10)	✓	11,77	6,28	<u>13,05</u>	<u>13,05</u>	8,24	4,39	10,46	9,49
	TFS08130	Ø8 x 130 (M10)	✓								
	TFS10120	Ø10 x 120 (M12)	✓								
	TFS10140	Ø10 x 140 (M12)	✓	14,67	8,77	<u>18,27</u>	17,10	10,27	6,14	13,56	11,97

*Ø5 Assessed only for use in concrete and in precast prestressed hollow core slabs for redundant non-structural systems

6.3 MAXIMUM RECOMMENDED LOADS (STRUCTURAL APPLICATION) [kN] (with $\gamma_F= 1.4$)

General Parameter				Non-cracked concrete				Cracked concrete			
Family	Code	Size	ETA Assessed	Tension $N_{rec,ucr}$		Shear $V_{rec,ucr}$		Tension $N_{rec,cr}$		Shear $V_{rec,cr}$	
				($h_{ef, std}$)	($h_{ef, red}$)	($h_{ef, std}$)	($h_{ef, red}$)	($h_{ef, std}$)	($h_{ef, red}$)	($h_{ef, std}$)	($h_{ef, red}$)
TFE	TFE05040	Ø5 x 40	✓*	--	3,20	--	3,20	--	2,24	--	2,24
	TFE05050	Ø5 x 50	✓*	4,85	3,20	<u>3,90</u>	3,20	3,40	2,24	3,40	2,24
	TFE05060	Ø5 x 60	✓*								
	TFE05080	Ø5 x 80	✓*								
	TFE05100	Ø5 x 100	✓*								
	TFE06035	Ø6 x 35	✓								
	TFE06040	Ø6 x 40	✓	1,98	5,97	1,81	4,46				
	TFE06045	Ø6 x 45	✓								
	TFE06050	Ø6 x 50	✓								
	TFE06060	Ø6 x 60	✓								
	TFE06070	Ø6 x 70	✓	6,61	1,98	<u>5,97</u>	<u>5,97</u>	4,62	1,81	5,32	4,46
	TFE06080	Ø6 x 80	✓								
	TFE06100	Ø6 x 100	✓								
	TFE06120	Ø6 x 120	✓								
	TFE08055	Ø8 x 55	✓								
	TFE08060	Ø8 x 60	✓	--	4,48	--	<u>9,32</u>	--	3,14	--	6,78
	TFE08070	Ø8 x 70	✓	8,41	4,48	<u>9,32</u>	<u>9,32</u>	5,88	3,14	7,47	6,78
	TFE08075	Ø8 x 75	✓								
	TFE08080	Ø8 x 80	✓								
	TFE08090	Ø8 x 90	✓								
	TFE08100	Ø8 x 100	✓								
	TFE08110	Ø8 x 110	✓								
	TFE08120	Ø8 x 120	✓								
	TFE08140	Ø8 x 140	✓								
	TFE10060	Ø10 x 60	✓	--	6,26	--	12,21	--	4,38	--	8,55
	TFE10070	Ø10 x 70	✓								
	TFE10080	Ø10 x 80	✓								
	TFE10090	Ø10 x 90	✓	12,85	6,26	<u>13,05</u>	12,21	8,99	4,38	<u>13,05</u>	8,55
	TFE10100	Ø10 x 100	✓								
	TFE10120	Ø10 x 120	✓								
	TFE10140	Ø10 x 140	✓								
	TFE10160	Ø10 x 160	✓								
TFE10180	Ø10 x 180	✓									
TFE12080	Ø12 x 80	✓	--	10,35	--	<u>17,73</u>	--	7,24	--	16,88	
TFE12090	Ø12 x 90	✓									
TFE12100	Ø12 x 100	✓									
TFE12110	Ø12 x 110	✓	17,87	10,35	<u>17,73</u>	<u>17,73</u>	12,51	7,24	<u>17,73</u>	16,88	
TFE12130	Ø12 x 130	✓									
TFE12150	Ø12 x 150	✓									
TFE14080	Ø14 x 80	✓	--	10,35	--	<u>25,10</u>	--	7,24	--	18,47	
TFE14100	Ø14 x 100	✓									
TFE14110	Ø14 x 110	✓									
TFE14120	Ø14 x 120	✓	20,67	10,35	<u>25,10</u>	<u>25,10</u>	14,47	7,24	<u>25,10</u>	18,47	
TFE14130	Ø14 x 130	✓									
TFE14140	Ø14 x 140	✓									
TFE14160	Ø14 x 160	✓									
TFE16100	Ø16 x 100	✓	--	--	--	--	14,47	7,24	<u>27,60</u>	15,50	
TFE16150	Ø16 x 150	✓	20,67	10,35	<u>27,60</u>	22,14	--	--	--	--	
TFE18100	Ø18 x 100	✓	--	13,57	--	36,10	--	9,50	--	25,27	
TFE18130	Ø18 x 130	✓									
TFE18160	Ø18 x 160	✓									
TFE18180	Ø18 x 180	✓	27,77	13,57	<u>38,47</u>	36,10	19,44	9,50	<u>38,47</u>	25,27	
TFE18200	Ø18 x 200	✓									

General Parameter				Non-cracked concrete				Cracked concrete			
Family	Code	Size	ETA Assessed	Tension $N_{rec, ucr}$		Shear $V_{rec, ucr}$		Tension $N_{rec, cr}$		Shear $V_{rec, cr}$	
				($h_{ef, sta}$)	($h_{ef, red}$)	($h_{ef, sta}$)	($h_{ef, red}$)	($h_{ef, sta}$)	($h_{ef, red}$)	($h_{ef, sta}$)	($h_{ef, red}$)
TFA	TFA05040	Ø5 x 40	✓*	--	3,20	--	3,20	--	2,24	--	2,24
	TFA05060	Ø5 x 60	✓*	4,85	3,20	<u>3,90</u>	3,20	3,40	2,24	3,40	2,24
	TFA05080	Ø5 x 80	✓*								
	TFA05100	Ø5 x 100	✓*								
	TFA06045	Ø6 x 45	✓	--	1,98	--	<u>5,97</u>	--	1,81	--	4,46
	TFA06050	Ø6 x 50	✓								
	TFA06060	Ø6 x 60	✓	6,61	1,98	<u>5,97</u>	<u>5,97</u>	4,62	1,81	5,32	4,46
	TFA06080	Ø6 x 80	✓								
	TFA06100	Ø6 x 100	✓								
	TFA06120	Ø6 x 120	✓								
	TFA06140	Ø6 x 140	✓	8,41	4,48	<u>9,32</u>	<u>9,32</u>	5,88	3,14	7,47	6,78
	TFA08060	Ø8 x 60	✓								
	TFA08080	Ø8 x 80	✓								
	TFA08100	Ø8 x 100	✓								
TFA08120	Ø8 x 120	✓	12,85	6,26	<u>13,05</u>	12,21	8,99	4,38	<u>13,05</u>	8,55	
TFA10100	Ø10 x 100	✓									
TFA10120	Ø10 x 120	✓									
TFT	TFT06040	Ø6 x 40	✓	--	1,98	--	<u>5,97</u>	--	1,81	--	4,46
	TFT06050	Ø6 x 50	✓								
	TFT06060	Ø6 x 60	✓	6,61	1,98	<u>5,97</u>	<u>5,97</u>	4,62	1,81	5,32	4,46
TFP	TFP05040	Ø5 x 40	✓*	--	3,20	--	3,20	--	2,24	--	2,24
	TFP05060	Ø5 x 60	✓*	4,85	3,20	<u>3,90</u>	3,20	3,40	2,24	3,40	2,24
	TFP06040	Ø6 x 40	✓								
	TFP06050	Ø6 x 50	✓	--	1,98	--	<u>5,97</u>	--	1,81	--	4,46
	TFP06060	Ø6 x 60	✓								
	TFP06080	Ø6 x 80	✓	6,61	1,98	<u>5,97</u>	<u>5,97</u>	4,62	1,81	5,32	4,46
	TFP06100	Ø6 x 100	✓								
	TFP08060	Ø8 x 60	✓	--	4,48	--	<u>9,32</u>	--	3,14	--	6,78
TFP08080	Ø8 x 80	✓									
TFN	TFN14080	Ø14 x 80	✓	--	10,35	--	25,10	--	7,24	--	18,47
TFF	TFF05035S	Ø5 x 35 (M6)	✓*	--	3,20	--	--	--	2,24	--	--
	TFF06035	Ø6 x 35 (M8-M10)	✓	--	1,98	--	--	--	1,81	--	--
	TFF06040	Ø6 x 40 (M8-M10)	✓								
	TFF06055	Ø6 x 55 (M8-M10)	✓	6,61	--	--	--	4,62	--	--	--
	TFF08050T	Ø8 x 50 (M10)	✓	--	4,48	--	<u>9,32</u>	--	3,14	--	--
	TFF08050W	Ø8 x 50 (M12)	✓								
TFM	TFM06035	Ø6 x 35 (M8)	✓	--	1,98	--	--	--	1,81	--	--
	TFM06055	Ø6 x 55 (M10)	✓	6,61	--	--	--	4,62	--	--	--
TFS	TFS06100	Ø6 x 100 (M8)	✓	6,61	1,98	<u>5,97</u>	<u>5,97</u>	4,62	1,81	5,32	4,46
	TFS06120	Ø6 x 120 (M8)	✓								
	TFS08110	Ø8 x 110 (M10)	✓	8,41	4,48	<u>9,32</u>	<u>9,32</u>	5,88	3,14	7,47	6,78
	TFS08130	Ø8 x 130 (M10)	✓								
	TFS10120	Ø10 x 120 (M12)	✓	10,48	6,26	<u>13,05</u>	12,21	7,34	4,38	9,68	8,55
	TFS10140	Ø10 x 140 (M12)	✓								

*Ø5 Assessed only for use in concrete and in precast prestressed hollow core slabs for redundant non-structural systems

PULL OUT INCREASING FACTOR FOR TENSION LOADS IN HIGH RESISTANCE CONCRETE ψ_c

Diameter	Ø5		Ø6		Ø8		Ø10			Ø12		Ø14		Ø18	
	($h_{ef, red}$)	($h_{ef, sta}$)	($h_{ef, red}$)	($h_{ef, sta}$)	($h_{ef, red}$)	($h_{ef, sta}$)	($h_{ef, 1}$)	($h_{ef, 2}$)	($h_{ef, 3}$)	($h_{ef, red}$)	($h_{ef, sta}$)	($h_{ef, red}$)	($h_{ef, sta}$)	($h_{ef, red}$)	($h_{ef, sta}$)
C30/37	1,00	1,00	1,16	1,22	1,21	1,22	1,22	1,17	1,22	1,16	1,22	1,21	1,20	1,22	1,17
C40/50	1,00	1,00	1,28	1,41	1,39	1,41	1,41	1,30	1,41	1,29	1,41	1,39	1,37	1,40	1,32
C50/60	1,00	1,00	1,39	1,58	1,54	1,58	1,58	1,42	1,58	1,40	1,58	1,55	1,51	1,57	1,42

7. RESISTANCES (HOLLOW CORE SLABS)

Resistances in hollow core slab class C30/37 for an isolated anchor without spacing or concrete edge distance effects are indicated in the following table:

Values underlined and in italics show Steel failure, **bold** values concrete failure and other indicate pull out failure.
1 KN ≈ 100 kg

7.1 CHARACTERISTIC RESISTANCE (NON-STRUCTURAL APPLICATION) [kN]

General Parameter				Hollow core slabs					
Family	Code	Size	ETA Assessed	Tension N _{Rk}			Shear V _{Rk}		
				(h _{ef1})	(h _{ef2})	(h _{ef3})	(h _{ef1})	(h _{ef2})	(h _{ef3})
TFE	TFE05040	Ø5 x 40	✓*	5,39	--	--	5,39	--	--
	TFE05050	Ø5 x 50	✓*		--	--		--	--
	TFE05060	Ø5 x 60	✓*		6,22	8,22		6,22	<i>8,19</i>
	TFE05080	Ø5 x 80	✓*						
	TFE05100	Ø5 x 100	✓*						
	TFE06035	Ø6 x 35	✓	5,39	--	--	5,39	--	--
	TFE06040	Ø6 x 40	✓		--	--		--	--
	TFE06045	Ø6 x 45	✓		--	--		--	--
	TFE06050	Ø6 x 50	✓		6,22	7,99		6,22	7,99
	TFE06060	Ø6 x 60	✓						
	TFE06070	Ø6 x 70	✓						
	TFE06080	Ø6 x 80	✓						
	TFE06100	Ø6 x 100	✓						
TFE06120	Ø6 x 120	✓							
TFA	TFA05040	Ø5 x 40	✓*	5,39	--	--	5,39	--	--
	TFA05060	Ø5 x 60	✓*		6,22	8,22		6,22	<i>8,19</i>
	TFA05080	Ø5 x 80	✓*						
	TFA05100	Ø5 x 100	✓*						
	TFA06045	Ø6 x 45	✓	5,39	--	--	5,39	--	--
	TFA06050	Ø6 x 50	✓		--	--		--	--
	TFA06060	Ø6 x 60	✓		6,22	7,99		6,22	7,99
	TFA06080	Ø6 x 80	✓						
	TFA06100	Ø6 x 100	✓						
THT	TFT06040	Ø6 x 40	✓	5,39	--	--	5,39	--	--
	TFT06050	Ø6 x 50	✓		6,22	7,99		6,22	7,99
	TFT06060	Ø6 x 60	✓						
THP	TFP05040	Ø5 x 40	✓*	5,39	--	--	5,39	--	--
	TFP05060	Ø5 x 60	✓*		6,22	8,22		6,22	<i>8,19</i>
	TFP06040	Ø6 x 40	✓	5,39	--	--	5,39	--	--
	TFP06050	Ø6 x 50	✓		6,22	7,99		6,22	7,99
	TFP06060	Ø6 x 60	✓						
	TFP06080	Ø6 x 80	✓						
TFF	TFF05035S	Ø5 x 35 (M6)	✓*	5,39	6,22	8,22	5,39	6,22	<i>8,19</i>
	TFF06035	Ø6 x 35 (M8-M10)	✓	5,39	6,22	7,99	5,39	6,22	7,99
	TFF06040	Ø6 x 40 (M8-M10)	✓						
	TFF06055	Ø6 x 55 (M8-M10)	✓						
TFM	TFM06035	Ø6 x 35 (M8)	✓	5,39	6,22	7,99	5,39	6,22	7,99
	TFM06055	Ø6 x 55 (M10)	✓						
TFS	TFS06100	Ø6 x 100 (M8)	✓	5,39	6,22	7,99	5,39	6,22	7,99
	TFS06120	Ø6 x 120 (M8)	✓						

Ø5 Homologado solamente para uso en hormigón y en losas alveolares prefabricadas para sistemas no-estructurales redundantes

7.2 DESIGN RESISTANCE (NON-STRUCTURAL APPLICATION) [kN]										
General Parameter				Hollow core slabs						
Family	Code	Size	ETA Assessed	Tension N_{Rd}			Shear V_{Rd}			
				(h_{ef1})	(h_{ef2})	(h_{ef3})	(h_{ef1})	(h_{ef2})	(h_{ef3})	
TFE	TFE05040	Ø5 x 40	✓*	2,99	--	--	3,59	--	--	
	TFE05050	Ø5 x 50	✓*		--	--		--	--	
	TFE05060	Ø5 x 60	✓*		3,45	4,57		4,14	<u>5,46</u>	
	TFE05080	Ø5 x 80	✓*							
	TFE05100	Ø5 x 100	✓*	2,99	--	--	3,59	--	--	
	TFE06035	Ø6 x 35	✓		--	--		--	--	
	TFE06040	Ø6 x 40	✓		3,45	4,44		4,14	5,33	
	TFE06045	Ø6 x 45	✓							
	TFE06050	Ø6 x 50	✓							
	TFE06060	Ø6 x 60	✓							
	TFE06070	Ø6 x 70	✓							
	TFE06080	Ø6 x 80	✓							
TFE06100	Ø6 x 100	✓								
TFE06120	Ø6 x 120	✓								
TFA	TFA05040	Ø5 x 40	✓*	2,99	--	--	3,59	--	--	
	TFA05060	Ø5 x 60	✓*		3,45	4,57		4,14	<u>5,46</u>	
	TFA05080	Ø5 x 80	✓*							
	TFA05100	Ø5 x 100	✓*							
	TFA06045	Ø6 x 45	✓	2,99	3,45	4,44	3,59	4,14	--	
	TFA06050	Ø6 x 50	✓							
	TFA06060	Ø6 x 60	✓							
	TFA06080	Ø6 x 80	✓							
	TFA06100	Ø6 x 100	✓							
TFA06120	Ø6 x 120	✓								
TFA06140	Ø6 x 140	✓								
THT	TFT06040	Ø6 x 40	✓	2,99	--	--	3,59	--	--	
	TFT06050	Ø6 x 50	✓		3,45	4,44		4,14	5,33	
	TFT06060	Ø6 x 60	✓							
THP	TFP05040	Ø5 x 40	✓*	2,99	--	--	3,59	--	--	
	TFP05060	Ø5 x 60	✓*		3,45	4,57		4,14	<u>5,46</u>	
	TFP06040	Ø6 x 40	✓	2,99	--	--	3,59	--	--	
	TFP06050	Ø6 x 50	✓							
	TFP06060	Ø6 x 60	✓		3,45	4,44		4,14	5,33	
	TFP06080	Ø6 x 80	✓							
	TFP06100	Ø6 x 100	✓							
TFF	TFF05035S	Ø5 x 35 (M6)	✓*	2,99	6,22	8,22	3,59	4,14	<u>5,46</u>	
	TFF06035	Ø6 x 35 (M8-M10)	✓	2,99	3,45	4,44	3,59	4,14	5,33	
	TFF06040	Ø6 x 40 (M8-M10)	✓							
	TFF06055	Ø6 x 55 (M8-M10)	✓							
TFM	TFM06035	Ø6 x 35 (M8)	✓	2,99	3,45	4,44	3,59	4,14	5,33	
	TFM06055	Ø6 x 55 (M10)	✓							
TFS	TFS06100	Ø6 x 100 (M8)	✓	2,99	3,45	4,44	3,59	4,14	5,33	
	TFS06120	Ø6 x 120 (M8)	✓							

Ø5 Homologado solamente para uso en hormigón y en losas alveolares prefabricadas para sistemas no-estructurales redundantes

7.3 MAXIMUM RECOMMENDED LOADS (NON-STRUCTURAL APPLICATION) [kN] (with $\gamma_f=1.4$)

General Parameter				Hollow core slabs					
Family	Code	Size	ETA Assessed	Tension N_{rec}			Shear V_{rec}		
				(h_{ef1})	(h_{ef2})	(h_{ef3})	(h_{ef1})	(h_{ef2})	(h_{ef3})
TFE	TFE05040	Ø5 x 40	✓*	2,14	--	--	2,57	--	--
	TFE05050	Ø5 x 50	✓*		--	--		--	--
	TFE05060	Ø5 x 60	✓*		2,47	3,26		2,96	<u>3,90</u>
	TFE05080	Ø5 x 80	✓*						
	TFE05100	Ø5 x 100	✓*	2,14	--	--	2,57	--	--
	TFE06035	Ø6 x 35	✓		--	--		--	--
	TFE06040	Ø6 x 40	✓		2,47	3,17		2,96	3,80
	TFE06045	Ø6 x 45	✓						
	TFE06050	Ø6 x 50	✓						
	TFE06060	Ø6 x 60	✓						
	TFE06070	Ø6 x 70	✓						
	TFE06080	Ø6 x 80	✓						
TFE06100	Ø6 x 100	✓							
TFE06120	Ø6 x 120	✓							
TFA	TFA05040	Ø5 x 40	✓*	2,14	--	--	2,57	--	--
	TFA05060	Ø5 x 60	✓*		2,47	3,26		2,96	<u>3,90</u>
	TFA05080	Ø5 x 80	✓*						
	TFA05100	Ø5 x 100	✓*						
	TFA06045	Ø6 x 45	✓	2,14	--	--	2,57	--	--
	TFA06050	Ø6 x 50	✓		2,47	3,17		2,96	3,80
	TFA06060	Ø6 x 60	✓						
	TFA06080	Ø6 x 80	✓						
	TFA06100	Ø6 x 100	✓						
	TFA06120	Ø6 x 120	✓						
THT	TFT06040	Ø6 x 40	✓	2,14	--	--	2,57	--	--
	TFT06050	Ø6 x 50	✓		2,47	3,17		2,96	3,80
	TFT06060	Ø6 x 60	✓						
THP	TFP05040	Ø5 x 40	✓*	2,14	--	--	2,57	--	--
	TFP05060	Ø5 x 60	✓*		2,47	3,26		2,96	<u>3,90</u>
	TFP06040	Ø6 x 40	✓	2,14	--	--	2,57	--	--
	TFP06050	Ø6 x 50	✓		2,47	3,17		2,96	3,80
	TFP06060	Ø6 x 60	✓						
	TFP06080	Ø6 x 80	✓						
	TFP06100	Ø6 x 100	✓						
TFF	TFF05035S	Ø5 x 35 (M6)	✓*	2,14	2,47	3,26	2,57	2,96	<u>3,90</u>
	TFF06035	Ø6 x 35 (M8-M10)	✓	2,14	2,47	3,17	2,57	2,96	3,80
	TFF06040	Ø6 x 40 (M8-M10)	✓						
	TFF06055	Ø6 x 55 (M8-M10)	✓						
TFM	TFM06035	Ø6 x 35 (M8)	✓	2,14	2,47	3,17	2,57	2,96	3,80
	TFM06055	Ø6 x 55 (M10)	✓						
TFS	TFS06100	Ø6 x 100 (M8)	✓	2,14	2,47	3,17	2,57	2,96	3,80
	TFS06120	Ø6 x 120 (M8)	✓						

Ø5 Homologado solamente para uso en hormigón y en losas alveolares prefabricadas para sistemas no-estructurales redundantes

8. OFFICIAL DOCUMENTATION

The following documents are available on our official website www.indexfix.com:

- European assessment ETA 20/0046 for Installation in cracked and non-cracked concrete according to guideline EAD 330232-01-0601, option 1, from $\varnothing 6$ to $\varnothing 18$.
- European assessment ETA 20/0494 for use in concrete and prestressed hollow core slabs for redundant non-structural systems according to guideline EAD 330747-00-0601 from $\varnothing 5$ to $\varnothing 6$.
- Declaration of performance DoP THE.
- VdS certificate CEA 4001:2021-01(07) *Guidelines for sprinklers systems. Planning and installation for applications of water extinguishing systems on concrete elements* from $\varnothing 8$ to $\varnothing 18$.
- Available in the anchor design software INDEXcal.