



TFE



TFA



TFT



TFP



TFN



TFM



TFF



TFS

## EIGENSCHAFTEN

- Funktion durch mechanische Überlagerung zwischen Gewinde und Beton.
- Für schwere Lasten. Hohe Feuerbeständigkeit.
- Zugelassen für 2 Einbautiefen bzw. bis zu 3 für  $\varnothing 10$ .
- Geeignet für ungerissenen und gerissenen Beton.
- Erfüllt die Richtlinie VdS CEA 4001:2021-01(07) „Richtlinien für Sprinkleranlagen. Planung und Einbau“
- Besonders geeignet bei geringen Abständen zwischen Anker bzw. Rändern.
- Einsatz für statische oder quasistatische Lasten und seismische Beanspruchung C1 und C2.
- Einfache Montage.
- Installation mit der Bohrung des Anbauteils.
- Vorbohren erforderlich; das Gewinde wird beim Einbau des Ankers im Baustoff erstellt.
- Wiederverwendbar
- Ausbau möglich, ohne auf dem Untergrund des Grundmaterials Spuren zu hinterlassen.
- Verschiedene Längen und Größen, flexibler Einbau.
- VdS verfügbar von  $\varnothing 8$  bis  $\varnothing 18$
- Verfügbar in INDEXcal

## ANWENDUNGEN

- Konstruktive Befestigungen in gerissenem und ungerissenem Beton in Innenräumen
- Verglasungen, Fenster und Schaufenster
- Regale und Rohrgestelle
- Montage von Geländern und Handläufen in Innenbereichen
- Befestigungen von Holzbauten an Beton.

## ZULASSUNGEN



## BAUSTOFFE



## VERFÜGBARE GRÖßEN

$\varnothing 5 - \varnothing 18$

## BOHRLOCHBEDINGUNGEN



TROCKEN

NASS

MIT WASSER  
GEFÜLLT





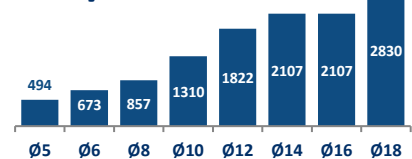











## MAX. EMPFOHLENE ZUGTRAGFÄHIGKEIT IN UNGERISSENEM BETON [kg]

TH/TF



## ANWENDUNGSBEISPIEL



1. SORTIMENT						
POS.	ARTIKELN	GRÖÖE	FOTO	BESCHREIBUNG	MATERIAL	BESCHICHTUNG
1	TFE	Ø5 - Ø18		Sechskant-Flanschkopf mit Bund	Gestanzter Kohlenstoffstahl, verzinkt ≥ 5 µm	
2	TFA	Ø5 - Ø10		Senkkopf	Gestanzter Kohlenstoffstahl, verzinkt ≥ 5 µm	
3	TFT	Ø6		Flachrundkopf	Gestanzter Kohlenstoffstahl, verzinkt ≥ 5 µm	
4	TFP	Ø5 - Ø8		Linsenkopf	Gestanzter Kohlenstoffstahl, verzinkt ≥ 5 µm	
5	TFN	Ø14		Sechskantkopf	Gestanzter Kohlenstoffstahl, verzinkt ≥ 5 µm	
6	TFF	Ø5 - Ø8		Kopf mit Hülse	Gestanzter Kohlenstoffstahl, verzinkt ≥ 5 µm	
7	TFM	Ø6		Sechskant-Flanschkopf mit überstehender Achse	Gestanzter Kohlenstoffstahl, verzinkt ≥ 5 µm	
8	TFS	Ø6 - Ø10		Kopf mit überstehender Achse, Unterlegscheibe und Mutter	Gestanzter Kohlenstoffstahl, verzinkt ≥ 5 µm	

2. EINBAUHINWEISE

2.1. EINBAUPLAN

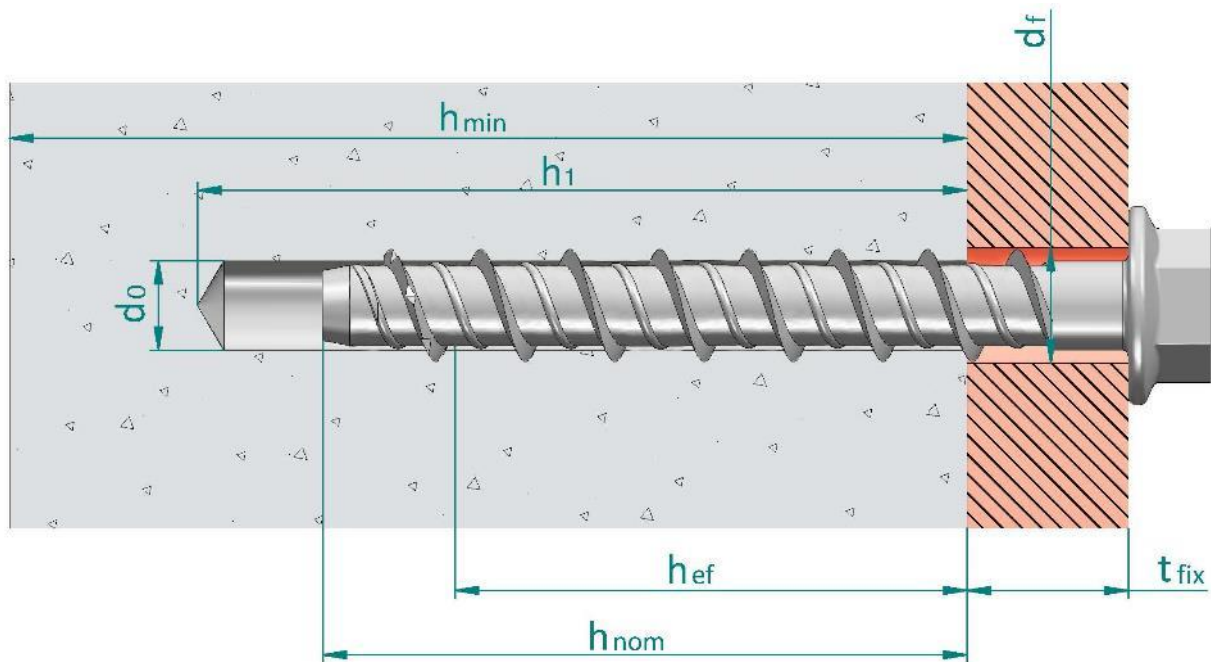

- $d_0$ : Nenn-Bohrungsdurchmesser
- $d_b$ : Bodenstärke der Spannbeton-Hohldecken
- $d_f$ : Durchmesser des Durchgangslochs im Anbauteil
- $h_{ef}$ : Effektive Verankerungstiefe
- $h_1$ : Bohrlochtiefe
- $h_{nom}$ : Verankerungstiefe im Beton
- $h_{min}$ : Minimale Betondicke
- $t_{fix}$ : Dicke des Anbauteils

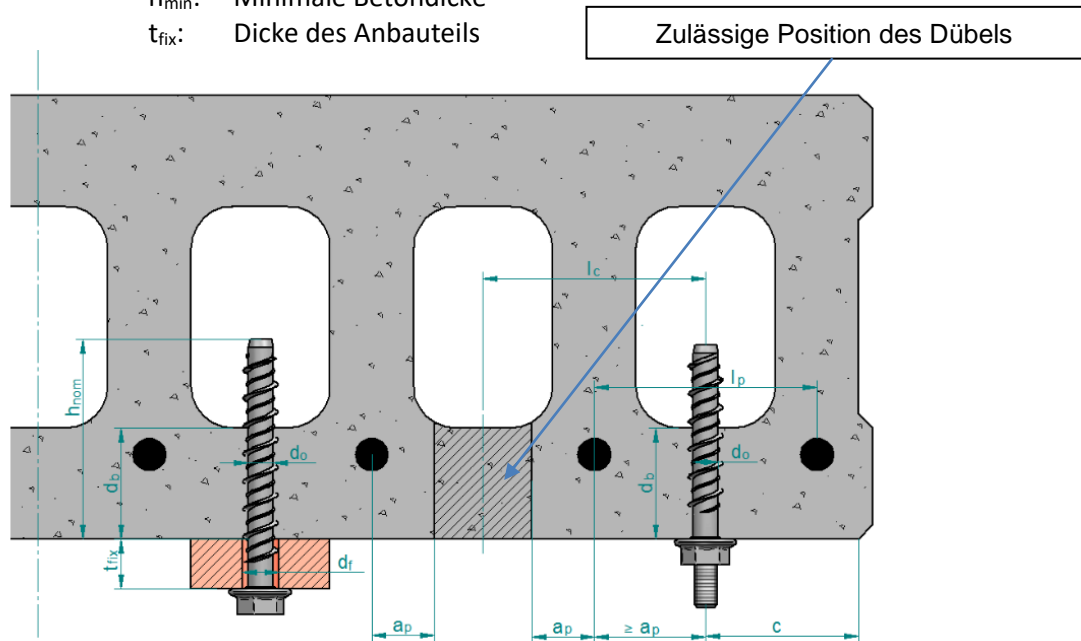

2.2. ERDBEBENZULASSUNG

Familie	Artikelnr.	Abmessung (Buchstabe)	Zulassung	C1	C2	Familie	Artikelnr.	Abmessung (Buchstabe)	Zulassung	C1	C2
[--]	[--]	[--]	ETA	[--]	[--]	[--]	[--]	[--]	ETA	[--]	[--]
TFE	TFE05040	Ø5 x 40 (A)	✓*	--	--	TFA	TFA05040	Ø5 x 40 (A)	✓*	--	--
	TFE05050	Ø5 x 50 (A)	✓*	--	--		TFA05060	Ø5 x 60 (B)	✓*	--	--
	TFE05060	Ø5 x 60 (B)	✓*	--	--		TFA05080	Ø5 x 80 (D)	✓*	--	--
	TFE05080	Ø5 x 80 (D)	✓*	--	--		TFA05100	Ø5 x 100 (E)	✓*	--	--
	TFE05100	Ø5 x 100 (E)	✓*	--	--		TFA06045	Ø6 x 45	✓	--	--
	TFE06035	Ø6 x 35	✓	--	--		TFA06050	Ø6 x 50	✓	--	--
	TFE06040	Ø6 x 40	✓	--	--		TFA06060	Ø6 x 60	✓	✓	--
	TFE06045	Ø6 x 45	✓	--	--		TFA06080	Ø6 x 80	✓	✓	--
	TFE06050	Ø6 x 50	✓	--	--		TFA06100	Ø6 x 100	✓	✓	--
	TFE06060	Ø6 x 60	✓	✓	--		TFA06120	Ø6 x 120	✓	✓	--
	TFE06070	Ø6 x 70	✓	✓	--		TFA06140	Ø6 x 140	✓	✓	--
	TFE06080	Ø6 x 80	✓	✓	--		TFA08060	Ø8 x 60	✓	✓	✓
	TFE06100	Ø6 x 100	✓	✓	--		TFA08080	Ø8 x 80	✓	✓	✓
	TFE06120	Ø6 x 120	✓	✓	--		TFA08100	Ø8 x 100	✓	✓	✓
	TFE08055	Ø8 x 55	✓	✓	✓		TFA08120	Ø8 x 120	✓	✓	✓
	TFE08060	Ø8 x 60	✓	✓	✓		TFA10100	Ø10 x 100	✓	✓	✓
	TFE08070	Ø8 x 70	✓	✓	✓		TFA10120	Ø10 x 120	✓	✓	✓
	TFE08075	Ø8 x 75	✓	✓	✓		TFT06040	Ø5 x 40	✓	--	--
	TFE08080	Ø8 x 80	✓	✓	✓		TFT06050	Ø5 x 50	✓	--	--
	TFE08090	Ø8 x 90	✓	✓	✓		TFT06060	Ø5 x 60	✓	✓	--
	TFE08100	Ø8 x 100	✓	✓	✓	TFP05040	Ø5 x 40 (A)	✓*	--	--	
	TFE08110	Ø8 x 110	✓	✓	✓	TFP05060	Ø5 x 60 (B)	✓*	--	--	
	TFE08120	Ø8 x 120	✓	✓	✓	TFP06040	Ø6 x 40	✓	--	--	
	TFE08140	Ø8 x 140	✓	✓	✓	TFP06050	Ø6 x 50	✓	--	--	
	TFE10060	Ø10 x 60	✓	--	--	TFP06060	Ø6 x 60	✓	✓	--	
	TFE10070	Ø10 x 70	✓	--	--	TFP06080	Ø6 x 80	✓	✓	--	
	TFE10080	Ø10 x 80	✓	--	--	TFP06100	Ø6 x 100	✓	✓	--	
	TFE10090	Ø10 x 90	✓	✓	✓	TFP08060	Ø8 x 60	✓	✓	✓	
	TFE10100	Ø10 x 100	✓	✓	✓	TFP08080	Ø8 x 80	✓	✓	✓	
	TFE10120	Ø10 x 120	✓	✓	✓	TFF05035S	Ø5 x 35 (M6)	✓*	--	--	
	TFE10140	Ø10 x 140	✓	✓	✓	TFF06035	Ø6 x 35 (M8-M10)	✓	--	--	
	TFE10160	Ø10 x 160	✓	✓	✓	TFF06040	Ø6 x 40 (M8-M10)	✓	--	--	
	TFE10180	Ø10 x 180	✓	✓	✓	TFF06055	Ø6 x 55 (M8-M10)	✓	--	--	
	TFE12080	Ø12 x 80	✓	--	--	TFF08050T	Ø8 x 50 (M10)	✓	--	--	
	TFE12090	Ø12 x 90	✓	--	--	TFF08050W	Ø8 x 50 (M12)	✓	--	--	
	TFE12100	Ø12 x 100	✓	--	--	TFM06035	Ø6 x 35 (M8)	✓	--	--	
	TFE12110	Ø12 x 110	✓	✓	✓	TFM06055	Ø6 x 55 (M10)	✓	--	--	
	TFE12130	Ø12 x 130	✓	✓	✓	TFN14080	Ø14 x 80	✓	--	--	
	TFE12150	Ø12 x 150	✓	✓	✓	TFS06100	Ø6 x 100 (M8)	✓	✓	--	
	TFE14080	Ø14 x 80	✓	--	--	TFS06120	Ø6 x 120 (M8)	✓	✓	--	
TFE14100	Ø14 x 100	✓	--	--	TFS08110	Ø8 x 110 (M10)	✓	✓	✓		
TFE14110	Ø14 x 110	✓	--	--	TFS08130	Ø8 x 130 (M10)	✓	✓	✓		
TFE14120	Ø14 x 120	✓	✓	✓	TFS10120	Ø10 x 120 (M12)	✓	--	--		
TFE14130	Ø14 x 130	✓	✓	✓	TFS10140	Ø10 x 140 (M12)	✓	--	--		
TFE14140	Ø14 x 140	✓	✓	✓							
TFE14160	Ø14 x 160	✓	✓	✓							
TFE16100	Ø16 x 100	✓	--	--							
TFE16150	Ø16 x 150	✓	--	--							
TFE18100	Ø18 x 100	✓	--	--							
TFE18130	Ø18 x 130	✓	--	--							
TFE18160	Ø18 x 160	✓	✓	✓							
TFE18180	Ø18 x 180	✓	✓	✓							
TFE18200	Ø18 x 200	✓	✓	✓							

3. EINBAUPARAMETER (BETON)

Allgemeine Einbaukennwerte										Standard-Einbautiefe (h <sub>ef, std</sub> )							Reduzierte Einbautiefe (h <sub>ef, red</sub> )										
Familie	Artikelnr.	Abmessung (Buchstabe)	Zulassung	Bohrungsdurchmesser	Bohrlochdurchmesser der zu befestigenden	Einbauschlüssel	Max. Einbaudrehmoment	Minimaler Achsabstand	Minimaler Abstand zum Rand	Minimale Betondicke	Bohrlochtiefe	Einbautiefe	Effektive Tiefe	Zu befestigende Dicke	Kritischer Achsabstand	Kritischer Abstand zum Rand (Ausbruch)	Kritischer Achsabstand (Spalten)	Kritischer Abstand zum Rand (Spalten)	Minimale Betondicke	Bohrlochtiefe	Einbautiefe	Effektive Tiefe	Zu befestigende Dicke	Kritischer Achsabstand	Kritischer Abstand zum Rand (Ausbruch)	Kritischer Achsabstand (Spalten)	Kritischer Abstand zum Rand (Spalten)
[--]	[--]	[--]	ETA	d <sub>0</sub> [mm]	d <sub>f</sub> [mm]	SW/Tx [--]	T <sub>inst</sub> [Nm]	S <sub>min</sub> [mm]	C <sub>min</sub> [mm]	h <sub>min</sub> [mm]	h <sub>1</sub> [mm]	h <sub>nom</sub> [mm]	h <sub>ef</sub> [mm]	t <sub>fix</sub> [mm]	S <sub>cr,N</sub> [mm]	C <sub>cr,N</sub> [mm]	S <sub>cr,sp</sub> [mm]	C <sub>cr,sp</sub> [mm]	h <sub>min</sub> [mm]	h <sub>1</sub> [mm]	h <sub>nom</sub> [mm]	h <sub>ef</sub> [mm]	t <sub>fix</sub> [mm]	S <sub>cr,N</sub> [mm]	C <sub>cr,N</sub> [mm]	S <sub>cr,sp</sub> [mm]	C <sub>cr,sp</sub> [mm]
TFE	TFE05040	Ø5 x 40(A)	✓*	5	6,5 - 8	SW 8	8	35	35	--	--	--	--	--	--	--	--	--	80	45	35	26,5	5	80	40	80	40
	TFE05050	Ø5 x 50(A)	✓*			SW 8				5	105	53	105	53	15												
	TFE05060	Ø5 x 60(B)	✓*			SW 8				15	35	55	45	35,0	35												
	TFE05080	Ø5 x 80(D)	✓*			SW 8				35	55	45	35,0	55													
	TFE05100	Ø5 x 100(E)	✓*			SW 8				55	55	45	35,0	55													
	TFE06035	Ø6 x 35	✓	6	7,5 - 9	SW 10	10	35	35	--	--	--	--	--	--	--	--	--	100	45	35	26,0	5	78	39	90	45
	TFE06040	Ø6 x 40	✓			SW 10				5	129	65	170	85	5												
	TFE06045	Ø6 x 45	✓			SW 10				10	129	65	170	85	15												
	TFE06050	Ø6 x 50	✓			SW 10				15	129	65	170	85	35												
	TFE06060	Ø6 x 60	✓			SW 10				25	129	65	170	85	45												
	TFE06070	Ø6 x 70	✓			SW 10				45	129	65	170	85	65												
	TFE06080	Ø6 x 80	✓			SW 10				65	129	65	170	85	85												
	TFE06100	Ø6 x 100	✓			SW 10				85	129	65	170	85	85												
	TFE06120	Ø6 x 120	✓			SW 10				85	129	65	170	85	85												
	TFE08055	Ø8 x 55	✓			8				10,5 - 12	SW 13	20	35	35	--	--	--	--									
	TFE08060	Ø8 x 60	✓	SW 13	10		76	200	100		10																
	TFE08070	Ø8 x 70	✓	SW 13	20		76	200	100		20																
	TFE08075	Ø8 x 75	✓	SW 13	25		76	200	100		25																
	TFE08080	Ø8 x 80	✓	SW 13	30		76	200	100		30																
	TFE08090	Ø8 x 90	✓	SW 13	40		76	200	100		40																
	TFE08100	Ø8 x 100	✓	SW 13	50		76	200	100		50																
TFE08110	Ø8 x 110	✓	SW 13	60	76		200	100	60																		
TFE08120	Ø8 x 120	✓	SW 13	70	76		200	100	70																		
TFE08140	Ø8 x 140	✓	SW 13	75	76		200	100	75																		

\*Ø5 Zulassung nur für Verankerungen in Beton und vorgefertigten Spannbeton-Hohldecken für redundante nichttragende Systeme

Allgemeine Einbaukennwerte										Standard-Einbautiefe ( $h_{ef, std}$ )								3Reduzierte Einbautiefe ( $h_{ef, red}$ )										
Familie	Artikelnr.	Abmessung (Buchstabe)	Zulassung	Bohrungsdurchmesser	Bohrlochdurchmesser der zu befestigenden	Einbauschlüssel	Max. Einbaudrehmoment	Minimaler Achsabstand	Minimaler Abstand zum Rand	Minimale Betondicke	Bohrlochtiefe	Einbautiefe	Effektive Tiefe	Zu befestigende Dicke	Kritischer Achsabstand	Kritischer Abstand zum Rand (Ausbruch)	Kritischer Achsabstand (Spalten)	Kritischer Abstand zum Rand (Spalten)	Minimale Betondicke	Bohrlochtiefe	Einbautiefe	Effektive Tiefe	Zu befestigende Dicke	Kritischer Achsabstand	Kritischer Abstand zum Rand (Ausbruch)	Kritischer Achsabstand (Spalten)	Kritischer Abstand zum Rand (Spalten)	
[--]	[--]	[--]	ETA	$d_0$	$d_f$	SW/Tx	$T_{inst}$	$S_{min}$	$C_{min}$	$h_{min}$	$h_1$	$h_{nom}$	$h_{ef}$	$t_{fix}$	$S_{cr,N}$	$C_{cr,N}$	$S_{cr,sp}$	$C_{cr,sp}$	$h_{min}$	$h_1$	$h_{nom}$	$h_{ef}$	$t_{fix}$	$S_{cr,N}$	$C_{cr,N}$	$S_{cr,sp}$	$C_{cr,sp}$	
				[mm]	[mm]	[--]	[Nm]	[mm]	[mm]	[mm]	[mm]	[mm]	[mm]	[mm]	[mm]	[mm]	[mm]	[mm]	[mm]	[mm]	[mm]	[mm]	[mm]	[mm]	[mm]	[mm]	[mm]	[mm]
TFE	TFE10060	Ø10 x 60	✓	10	12,5 - 14	SW 15	30	50	40	--	--	--	--	--	--	--	--	--	100	65	55	41,5	5	125	63	140	70	
	TFE10070	Ø10 x 70	✓			15																						
	TFE10080	Ø10 x 80	✓			25																						
	TFE10090	Ø10 x 90	✓			35																						
	TFE10100	Ø10 x 100	✓			45																						
	TFE10120	Ø10 x 120	✓			65																						
	TFE10140	Ø10 x 140	✓			85																						
	TFE10160	Ø10 x 160	✓			105																						
	TFE10180	Ø10 x 180	✓			125																						
	TFE12080	Ø12 x 80	✓	12	14,8 - 16	SW 18	50	75	45	--	--	--	--	--	--	--	--	--	120	90	75	58,0	5	174	87	190	95	
	TFE12090	Ø12 x 90	✓			15																						
	TFE12100	Ø12 x 100	✓			25																						
	TFE12110	Ø12 x 110	✓			35																						
	TFE12130	Ø12 x 130	✓			55																						
	TFE12150	Ø12 x 150	✓			75																						
	TFE14080	Ø14 x 80	✓	14	16,9 - 18	SW 21	70	80	50	--	--	--	--	--	--	--	--	--	120	90	75	58,0	5	174	87	190	95	
	TFE14100	Ø14 x 100	✓			25																						
	TFE14110	Ø14 x 110	✓			35																						
	TFE14120	Ø14 x 120	✓			45																						
	TFE14130	Ø14 x 130	✓			55																						
TFE14140	Ø14 x 140	✓	65																									
TFE14160	Ø14 x 160	✓	85																									
TFE16100	Ø16 x 100	✓	16	18,9 - 20	SW24	80	80	50	--	--	--	--	--	--	--	--	--	115	100	80	58	20	174	87	180	90		
TFE16150	Ø16 x 150	✓			70																							
TFE18100	Ø18 x 100	✓	18	20,9 - 22	SW 24	90	90	55	--	--	--	--	--	--	--	--	--	--	140	110	90	69,5	10	209	105	230	115	
TFE18130	Ø18 x 130	✓			40																							
TFE18160	Ø18 x 160	✓			70																							
TFE18180	Ø18 x 180	✓			90																							
TFE18200	Ø18 x 200	✓			110																							
					110																							

Allgemeine Einbaukennwerte										Standard-Einbautiefe ( $h_{ef, std}$ )								Reduzierte Einbautiefe ( $h_{ef, red}$ )									
Familie	Artikelnr.	Abmessung (Buchstabe)	Zulassung	Bohrungsdurchmesser	Bohrlochdurchmesser der zu befestigenden	Einbauschlüssel	Max. Einbaudrehmoment	Minimaler Achsabstand	Minimaler Abstand zum Rand	Minimale Betondecke	Bohrlochtiefe	Einbautiefe	Effektive Tiefe	Zu befestigende Dicke	Kritischer Achsabstand	Kritischer Abstand zum Rand (Ausbruch)	Kritischer Achsabstand (Spalten)	Kritischer Abstand zum Rand (Spalten)	Minimale Betondecke	Bohrlochtiefe	Einbautiefe	Effektive Tiefe	Zu befestigende Dicke	Kritischer Achsabstand	Kritischer Abstand zum Rand (Ausbruch)	Kritischer Achsabstand (Spalten)	Kritischer Abstand zum Rand (Spalten)
				$d_0$	$d_f$					SW/Tx	$T_{inst}$	$S_{min}$	$C_{min}$	$h_{min}$	$h_1$	$h_{nom}$	$h_{ef}$	$t_{fix}$	$S_{Cr,N}$	$C_{Cr,N}$	$S_{Cr,sp}$	$C_{Cr,sp}$	$h_{min}$	$h_1$	$h_{nom}$	$h_{ef}$	$t_{fix}$
[--]	[--]	[--]	ETA	[mm]	[mm]	[--]	[Nm]	[mm]	[mm]	[mm]	[mm]	[mm]	[mm]	[mm]	[mm]	[mm]	[mm]	[mm]	[mm]	[mm]	[mm]	[mm]	[mm]	[mm]	[mm]	[mm]	[mm]
TFA	TFA05040	Ø5 x 40(A)	✓*	5	6,5 - 8	TX25	8	35	35	--	--	--	--	--	--	--	--	--	80	45	35	26,5	5	80	40	80	40
	TFA05060	Ø5 x 60(B)	✓*			TX25				15	25																
	TFA05080	Ø5 x 80(D)	✓*			TX25				35	45																
	TFA05100	Ø5 x 100(E)	✓*			TX25				55	65																
	TFA06045	Ø6 x 45	✓	6	7,5 - 9	TX30	10	35	35	--	--	--	--	--	--	--	--	--	100	45	35	26,0	10	78	39	90	45
	TFA06050	Ø6 x 50	✓			TX30				15																	
	TFA06060	Ø6 x 60	✓			TX30				5	25																
	TFA06080	Ø6 x 80	✓			TX30				45	65																
	TFA06100	Ø6 x 100	✓			TX30				129	170																
	TFA06120	Ø6 x 120	✓			TX30				65	85																
	TFA06140	Ø6 x 140	✓			TX30				85	105																
	TFA08060	Ø8 x 60	✓			8				10,5 - 12	TX45	20	35	35	--	--	--	--					--				
	TFA08080	Ø8 x 80	✓	TX45	15		30																				
	TFA08100	Ø8 x 100	✓	TX45	35		50																				
TFA08120	Ø8 x 120	✓	TX45	55	70																						
TFA10100	Ø10 x 100	✓	10	12,5 - 14	TX50	30	50	40	135	95	85	67,0	15	201	101	210	105	100	65	55	41,5	45	125	63	140	70	
TFA10120	Ø10 x 120	✓			TX50				35	65																	
TFT	TFT06040	Ø6 x 40	✓	6	7,5 - 9	TX30	10	35	35	--	--	--	--	--	--	--	--	--	100	45	35	26,0	5	78	39	90	45
	TFT06050	Ø6 x 50	✓			TX30				15	25																
	TFT06060	Ø6 x 60	✓			TX30				100	129																
TFP	TFP05040	Ø5 x 40(A)	✓*	5	6,5 - 8	TX30	8	35	35	--	--	--	--	--	--	--	--	--	80	45	35	26,5	5	80	40	80	40
	TFP05060	Ø5 x 60(B)	✓*			TX30				15	25																
	TFP06040	Ø6 x 40	✓	6	7,5 - 9	TX40	10	35	35	--	--	--	--	--	--	--	--	--	100	45	35	26,0	5	78	39	90	45
	TFP06050	Ø6 x 50	✓			TX40				15	25																
	TFP06060	Ø6 x 60	✓			TX40				25	45																
	TFP06080	Ø6 x 80	✓			TX40				129	170																
	TFP06100	Ø6 x 100	✓			TX40				45	65																
	TFP08060	Ø8 x 60	✓			8				10,5 - 12	TX45	20	35	35	--	--	--	--					--				
TFP08080	Ø8 x 80	✓	TX45	15	30																						
TFN	TFN14080	Ø14 x 80	✓	14	16,9 - 18	SW 24	70	80	50	--	--	--	--	--	--	--	--	--	120	90	75	58,0	5	174	87	190	95

\*Ø5 Zulassung nur für Verankerungen in Beton und vorgefertigten Spannbeton-Hohldecken für redundante nichttragende Systeme

Allgemeine Einbaukennwerte										Standard-Einbautiefe ( $h_{ef, std}$ )									Reduzierte Einbautiefe ( $h_{ef, red}$ )								
Familie	Artikelnr.	Abmessung (Buchstabe)	Zulassung	Bohrungsdurchmesser	Bohrlochdurchmesser der zu befestigenden	Einbauschlüssel	Max. Einbaudrehmoment	Minimaler Achsabstand	Minimaler Abstand zum Rand	Minimale Betondecke	Bohrlochtiefe	Einbautiefe	Effektive Tiefe	Zu befestigende Dicke	Kritischer Achsabstand	Kritischer Abstand zum Rand (Ausbruch)	Kritischer Achsabstand (Spalten)	Kritischer Abstand zum Rand (Spalten)	Minimale Betondecke	Bohrlochtiefe	Einbautiefe	Effektive Tiefe	Zu befestigende Dicke	Kritischer Achsabstand	Kritischer Abstand zum Rand (Ausbruch)	Kritischer Achsabstand (Spalten)	Kritischer Abstand zum Rand (Spalten)
				$d_0$	$d_f$																						
[--]	[--]	[--]	ETA	[mm]	[mm]	[--]	[Nm]	[mm]	[mm]	[mm]	[mm]	[mm]	[mm]	[mm]	[mm]	[mm]	[mm]	[mm]	[mm]	[mm]	[mm]	[mm]	[mm]	[mm]	[mm]	[mm]	[mm]
TFF	TFF05035S	Ø5 x 35 (M6)	✓*	5	--	SW10	8	35	35	--	--	--	--	--	--	--	--	--	80	45	35	26,5	--	80	40	80	40
	TFF06035	Ø6 x 35 (M8-M10)	✓	6	--	SW 13	10	35	35	--	--	--	--	--	--	--	--	--	100	45	35	26,0	--	78	39	90	45
	TFF06040	Ø6 x 40 (M8-M10)	✓			SW 13				--	--	--	--	--	100	45	35	26,0	--	78	39	90	45				
	TFF06055	Ø6 x 55 (M8-M10)	✓			SW 13				100	65	55	43,0	--	129	65	170	85	--	--	--	--	--				
	TFF08050T	Ø8 x 50 (M10)	✓	8	--	SW 13	20	35	35	--	--	--	--	--	--	--	--	--	100	60	50	37,5	--	113	57	130	65
	TFF08050W	Ø8 x 50 (M12)	✓			SW 17				--	--	--	--	--	100	60	50	37,5	--	113	57	130	65				
TFM	TFM06035	Ø6 x 35 (M8)	✓	6	--	SW 13	10	35	35	--	--	--	--	--	--	--	--	100	65	55	26,0	--	78	39	90	45	
	TFM06055	Ø6 x 55 (M10)	✓			SW 13				100	65	55	43,0	--	129	65	170	85	--	--	--	--	--				
TFS	TFS06100	Ø6 x 100 (M8)	✓	6	7,5 - 9	SW 5	10	35	35	100	65	55	43,0	31	129	65	170	85	100	45	35	26,0	51	78	39	90	45
	TFS06120	Ø6 x 120 (M8)	✓			SW 5								51									71				
	TFS08110	Ø8 x 110 (M10)	✓	8	10,5 - 12	SW 7	20	35	35	100	75	65	50,5	29	152	76	200	100	100	60	50	37,5	44	113	57	130	65
	TFS08130	Ø8 x 130 (M10)	✓			SW 7								49									64				
	TFS10120	Ø10 x 120 (M12)	✓	10	12,5 - 14	SW 8	30	50	40	120	85	75	58,5	16	176	88	190	95	100	65	55	41,5	46	125	63	140	70
	TFS10140	Ø10 x 140 (M12)	✓			SW 8								36									66				



4. EINBAUPARAMETER (HOHLKÖRPERPLATTEN) [Einbautiefe Reduzierte /Mittel/ Standard]

Allgemeine Einbaukennwerte											Einbautiefe ( $h_{ef1}$ / $h_{ef2}$ / $h_{ef3}$ )								
Familie	Artikelnr.	Abmessung (Buchstabe)	Zulassung	Bohrungsdurchmesser	Bohrlochdurchmesser der zu befestigenden	Einbauschlüssel	Max. Einbaudrehrmoment	Minimaler Achsabstand	Minimaler Abstand zum Rand	Bodenstärke der Spannbeton-Hohldecken	Bohrlochtiefe	Einbautiefe	Effektive Tiefe	Zu befestigende Dicke	Kritischer Achsabstand (Ausbruch)	Kritischer Abstand zum Rand (Ausbruch)	Kritischer Achsabstand (Spalten)	Kritischer Abstand zum Rand (Spalten)	
[--]	[--]	[--]	ETA	$d_0$	$d_f$	SW/Tx	$T_{inst}$	$S_{min}$	$C_{min}$	$d_b$	$h_1$	$h_{nom}$	$h_{ef}$	$t_{fix}$	$S_{cr,N}$	$C_{cr,N}$	$S_{cr,sp}$	$C_{cr,sp}$	
				[mm]	[mm]	[--]	[Nm]	[mm]	[mm]	[mm]	[mm]	[mm]	[mm]	[mm]	[mm]	[mm]	[mm]	[mm]	
TFE	TFE05040	Ø5 x 40(A)	✓*	5	6,5 - 8	SW 8	8	35	35	25/30/40	30/40/45	30/40/45	20/22/26,5	10/--/--	60/66/80	30/33/40	80	80	
	TFE05050	Ø5 x 50(A)	✓*			20/10/5													
	TFE05060	Ø5 x 60(B)	✓*			30/20/15													
	TFE05080	Ø5 x 80(D)	✓*			50/40/35													
	TFE05100	Ø5 x 100(E)	✓*			70/60/55													
	TFE06035	Ø6 x 35	✓	6	7,5 - 9	SW 10	10	35	35	25/30/40	30/40/45	30/40/45	20/22/26	5/--/--	60/66/78	30/33/39	90	45	
	TFE06040	Ø6 x 40	✓			10/--/--													
	TFE06045	Ø6 x 45	✓			15/5/--													
	TFE06050	Ø6 x 50	✓			20/10/5													
	TFE06060	Ø6 x 60	✓			30/20/15													
	TFE06070	Ø6 x 70	✓			40/30/25													
	TFE06080	Ø6 x 80	✓			50/40/35													
	TFE06100	Ø6 x 100	✓			70/60/55													
	TFE06120	Ø6 x 120	✓			90/80/75													
TFE06140	Ø6 x 140	✓	110/100/95																
TFA	TFA05040	Ø5 x 40(A)	✓*	5	6,5 - 8	TX25	8	35	35	25/30/40	30/40/45	30/40/45	20/22/26,5	10/--/--	60/66/80	30/33/40	80	80	
	TFA05060	Ø5 x 60(B)	✓*			30/20/15													
	TFA05080	Ø5 x 80(D)	✓*			50/40/35													
	TFA05100	Ø5 x 100(E)	✓*			70/60/55													
	TFA06045	Ø6 x 45	✓	6	7,5 - 9	TX30	10	35	35	25/30/40	30/40/45	30/40/45	20/22/26	15/5/--	60/66/78	30/33/39	90	45	
	TFA06050	Ø6 x 50	✓			20/10/5													
	TFA06060	Ø6 x 60	✓			30/20/15													
	TFA06080	Ø6 x 80	✓			50/40/35													
	TFA06100	Ø6 x 100	✓			70/60/55													
	TFA06120	Ø6 x 120	✓			90/80/75													
	TFA06140	Ø6 x 140	✓			110/100/95													

\*Ø5 Zulassung nur für Verankerungen in Beton und vorgefertigten Spannbeton-Hohldecken für redundante nichttragende Systeme

Allgemeine Einbaukennwerte										Einbautiefe ( $h_{ef1}/ h_{ef2}/ h_{ef3}$ )								
Familie	Artikelnr.	Abmessung (Buchstabe)	Zulassung	Bohrungsdurchmesser	Bohrlochdurchmesser der zu befestigenden	Einbauschlüssel	Max. Einbaudrehmoment	Minimaler Achsabstand	Minimaler Abstand zum Rand	Bodenstärke der Spannbeton-Hohldecken	Bohrlochtiefe	Einbautiefe	Effektive Tiefe	Zu befestigende Dicke	Kritischer Achsabstand (Ausbruch)	Kritischer Abstand zum Rand (Ausbruch)	Kritischer Achsabstand (Spalten)	Kritischer Abstand zum Rand (Spalten)
				$d_0$	$d_f$													
[--]	[--]	[--]	ETA	[mm]	[mm]	[--]	[Nm]	[mm]	[mm]	[mm]	[mm]	[mm]	[mm]	[mm]	[mm]	[mm]	[mm]	[mm]
TFT	TFT06040	Ø6 x 40	✓	6	7,5 - 9	TX30	10	35	35	25/30/40	30/40/45	30/40/45	20/22/26	10/--/--	60/66/78	30/33/39	90	45
	TFT06050	Ø6 x 50	✓			TX30								20/10/5				
	TFT06060	Ø6 x 60	✓			TX30								30/20/15				
TFP	TFP05040	Ø5 x 40(A)	✓*	5	6,5 - 8	TX30	8	35	35	25/30/40	30/40/45	30/40/45	20/22/26,5	10/--/--	60/66/80	30/33/40	80	80
	TFP05060	Ø5 x 60(B)	✓*			TX30								30/20/15				
	TFP06040	Ø6 x 40	✓	6	7,5 - 9	TX40	10	35	35	25/30/40	30/40/45	30/40/45	20/22/26	10/--/--	60/66/78	30/33/39	90	45
	TFP06050	Ø6 x 50	✓			TX40								20/10/5				
	TFP06060	Ø6 x 60	✓			TX40								30/20/15				
	TFP06080	Ø6 x 80	✓			TX40								50/40/35				
	TFP06100	Ø6 x 100	✓			TX40								70/60/55				
TFF	TFF05035S	Ø5 x 35 (M6)	✓*	5	6,5 - 8	SW10	8	35	35	25/30/40	30/40/45	30/40/45	20/22/26	--/--/--	60/66/80	30/33/40	80	80
	TFF06035	Ø6 x 35 (M8-M10)	✓	6	7,5 - 9	SW 13	10	35	35	25/30/40	30/40/45	30/40/45	20/22/26	--/--/--	60/66/78	30/33/39	90	45
	TFF06040	Ø6 x 40 (M8-M10)	✓															
	TFF06055	Ø6 x 55 (M8-M10)	✓															
TFM	TFM06035	Ø6 x 35 (M8)	✓	6	7,5 - 9	SW 13	10	35	35	25/30/40	30/40/45	30/40/45	20/22/26	--/--/--	60/66/78	30/33/39	90	45
	TFM06055	Ø6 x 55 (M10)	✓															
TFS	TFS06100	Ø6 x 100 (M8)	✓	6	7,5 - 9	SW 5	10	35	35	25/30/40	30/40/45	30/40/45	20/22/26	56/46/41	60/66/78	30/33/39	90	45
	TFS06120	Ø6 x 120 (M8)	✓											76/66/61				

\*Ø5 Zulassung nur für Verankerungen in Beton und vorgefertigten Spannbeton-Hohldecken für redundante nichttragende Systeme

**5. EINBAUVERFAHREN**

**5.1 EINBAU IN BETON UND HOHLKÖRPERPLATTEN**

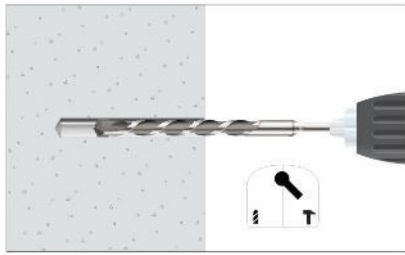

**1. BOHRLOCH ERSTELLEN**

Sicherstellen, dass der Beton ausreichend verdichtet ist und keine bedeutende Porenbildung aufweist.

Verwendbar mit trockenen, feuchten oder mit Wasser gefüllten Bohrlöchern.

Bohrlocherstellung mittels Schlag- oder Hammerbohren.

Das Bohrloch mit dem spezifizierten Durchmesser und der spezifizierten Tiefe erstellen.



**2. AUSBLASEN UND REINIGEN**

Das Bohrloch von Staubresten und Bohrungsrückständen reinigen (siehe Grafik).

Hierzu eine Luftpumpe und eine Bürste verwenden.

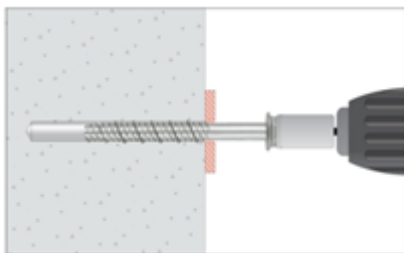

**3. EINBAUEN**

Einen Schlagschrauber verwenden, der das in den obigen Tabellen angegebene maximale Drehmoment nicht überschreitet.

Für die jeweilige Größe den passenden Innensechskant bzw. das passende Bit verwenden.

Einbau durch das zu befestigende Material.

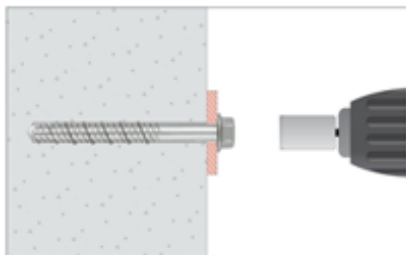

**4. FESTZIEHEN**

Die Verankerung in das Bohrloch einbringen, bis der Kopf bündig mit der Oberfläche des Baustoffs abschließt.

Der Dübel muss nach der Montage fest sitzen.

## 6. TRAGFÄHIGKEIT

Die Tragfähigkeitswerte in Beton C20/25 für eine einzelne Verankerung ohne Einwirkung von Rand- oder Achsabstand-Effekten werden in der nachfolgenden Tabelle angegeben:

Unterstrichene und kursiv gedruckte Werte geben das Stahlversagen an; die **fett** gedruckten Werte geben das Versagen durch Betonausbruch und die restlichen das Versagen durch Herausziehen an.

1 KN ≈ 100 kg

### 6.1 CHARAKTERISTISCHE FESTIGKEIT (TRAGENDE ANWENDUNGEN)[kN]

Allgemeine Parameter				Ungerissener Beton				Gerissener Beton											
Familie	Artikelnr.	Größe	ETA-Zulassung	Zuglast $N_{Rk, ucr}$		Querlast $V_{Rk, ucr}$		Zuglast $N_{Rk, cr}$		Querlast $V_{Rk, cr}$									
				( $h_{ef, std}$ )	( $h_{ef, red}$ )	( $h_{ef, std}$ )	( $h_{ef, red}$ )	( $h_{ef, std}$ )	( $h_{ef, red}$ )	( $h_{ef, std}$ )	( $h_{ef, red}$ )								
TFE	TFE05040	Ø5 x 40	✓*	--	<b>6,71</b>	--	<b>6,71</b>	--	<b>4,70</b>	--	<b>4,70</b>								
	TFE05050	Ø5 x 50	✓*	<b>10,19</b>	<b>6,71</b>	<u>8,19</u>	<b>6,71</b>	<b>7,13</b>	<b>4,70</b>	<b>7,13</b>	<b>4,70</b>								
	TFE05060	Ø5 x 60	✓*																
	TFE05080	Ø5 x 80	✓*																
	TFE05100	Ø5 x 100	✓*																
	TFE06035	Ø6 x 35	✓	--	5,00	--	<u>12,53</u>	--	<b>4,57</b>	--	<b>9,36</b>								
	TFE06040	Ø6 x 40	✓																
	TFE06045	Ø6 x 45	✓																
	TFE06050	Ø6 x 50	✓																
	TFE06060	Ø6 x 60	✓	<b>13,87</b>	5,00	<u>12,53</u>	<u>12,53</u>	<b>9,71</b>	<b>4,57</b>	<b>11,17</b>	<b>9,36</b>								
	TFE06070	Ø6 x 70	✓																
	TFE06080	Ø6 x 80	✓																
	TFE06100	Ø6 x 100	✓																
	TFE06120	Ø6 x 120	✓																
	TFE08055	Ø8 x 55	✓									--	<b>11,30</b>	--	<u>19,57</u>	--	<b>7,91</b>	--	<b>14,23</b>
	TFE08060	Ø8 x 60	✓																
	TFE08070	Ø8 x 70	✓	<b>17,65</b>	<b>11,30</b>	<u>19,57</u>	<u>19,57</u>	<b>12,36</b>	<b>7,91</b>	<b>15,69</b>	<b>14,23</b>								
	TFE08075	Ø8 x 75	✓																
	TFE08080	Ø8 x 80	✓																
	TFE08090	Ø8 x 90	✓																
	TFE08100	Ø8 x 100	✓																
	TFE08110	Ø8 x 110	✓																
	TFE08120	Ø8 x 120	✓																
	TFE08140	Ø8 x 140	✓	--	<b>13,15</b>	--	<b>25,65</b>	--	<b>9,21</b>	--	<b>17,95</b>								
	TFE10060	Ø10 x 60	✓																
	TFE10070	Ø10 x 70	✓																
	TFE10080	Ø10 x 80	✓																
	TFE10090	Ø10 x 90	✓	<b>26,98</b>	<b>13,15</b>	<u>27,40</u>	<b>25,65</b>	<b>18,89</b>	<b>9,21</b>	<u>27,40</u>	<b>17,95</b>								
	TFE10100	Ø10 x 100	✓																
	TFE10120	Ø10 x 120	✓																
	TFE10140	Ø10 x 140	✓																
	TFE10160	Ø10 x 160	✓																
	TFE10180	Ø10 x 180	✓																
	TFE12080	Ø12 x 80	✓	--	<b>21,73</b>	--	<u>37,24</u>	--	<b>15,21</b>	--	<b>35,44</b>								
	TFE12090	Ø12 x 90	✓																
	TFE12100	Ø12 x 100	✓	<b>37,54</b>	<b>21,73</b>	<u>37,24</u>	<u>37,24</u>	<b>26,27</b>	<b>15,21</b>	<u>37,24</u>	<b>35,44</b>								
	TFE12110	Ø12 x 110	✓																
	TFE12130	Ø12 x 130	✓																
	TFE12150	Ø12 x 150	✓																
	TFE14080	Ø14 x 80	✓	--	<b>21,73</b>	--	<u>52,72</u>	--	<b>15,21</b>	--	<b>38,79</b>								
TFE14100	Ø14 x 100	✓																	
TFE14110	Ø14 x 110	✓	<b>43,41</b>	<b>21,73</b>	<u>52,72</u>	<u>52,72</u>	<b>30,39</b>	<b>15,21</b>	<u>52,72</u>	<b>38,79</b>									
TFE14120	Ø14 x 120	✓																	
TFE14130	Ø14 x 130	✓																	
TFE14140	Ø14 x 140	✓																	
TFE14160	Ø14 x 160	✓	--	--	--	--	<b>30,39</b>	<b>15,21</b>	<u>52,72</u>	<b>32,55</b>									
TFE16100	Ø16 x 100	✓																	
TFE16150	Ø16 x 150	✓	<b>43,41</b>	<b>21,73</b>	<u>57,97</u>	<b>46,50</b>	<b>30,39</b>	<b>15,21</b>	<u>52,72</u>	<b>32,55</b>									
TFE18100	Ø18 x 100	✓	--	<b>28,50</b>	--	<b>75,82</b>	--	<b>19,95</b>	--	<b>53,07</b>									
TFE18130	Ø18 x 130	✓																	
TFE18160	Ø18 x 160	✓	<b>58,31</b>	<b>28,50</b>	<u>80,78</u>	<b>75,82</b>	<b>40,82</b>	<b>19,95</b>	<u>80,78</u>	<b>53,07</b>									
TFE18180	Ø18 x 180	✓																	
TFE18200	Ø18 x 200	✓																	

Allgemeine Parameter				Ungerissener Beton				Gerissener Beton			
Familie	Artikelnr.	Größe	ETA-Zulassung	Zuglast $N_{Rk, ucr}$		Querlast $V_{Rk, ucr}$		Zuglast $N_{Rk, cr}$		Querlast $V_{Rk, cr}$	
				( $h_{ef, sta}$ )	( $h_{ef, red}$ )	( $h_{ef, sta}$ )	( $h_{ef, red}$ )	( $h_{ef, sta}$ )	( $h_{ef, red}$ )	( $h_{ef, sta}$ )	( $h_{ef, red}$ )
TFA	TFA05040	Ø5 x 40	✓*	--	6,71	--	6,71	--	4,70	--	4,70
	TFA05060	Ø5 x 60	✓*	10,19	6,71	<u>8,19</u>	6,71	7,13	4,70	7,13	4,70
	TFA05080	Ø5 x 80	✓*								
	TFA05100	Ø5 x 100	✓*								
	TFA06045	Ø6 x 45	✓	--	5,00	--	<u>12,53</u>	--	4,57	--	9,36
	TFA06050	Ø6 x 50	✓	--		--		--			
	TFA06060	Ø6 x 60	✓	13,87	5,00	<u>12,53</u>	<u>12,53</u>	9,71	4,57	11,17	9,36
	TFA06080	Ø6 x 80	✓								
	TFA06100	Ø6 x 100	✓								
	TFA06120	Ø6 x 120	✓								
	TFA06140	Ø6 x 140	✓								
	TFA08060	Ø8 x 60	✓	--	11,30	--	<u>19,57</u>	--	7,91	--	14,23
	TFA08080	Ø8 x 80	✓	17,65	11,30	<u>19,57</u>	<u>19,57</u>	12,36	7,91	15,69	14,23
	TFA08100	Ø8 x 100	✓								
TFA08120	Ø8 x 120	✓									
TFA10100	Ø10 x 100	✓	26,98	13,15	<u>27,40</u>	25,65	18,89	9,21	<u>27,40</u>	17,95	
TFA10120	Ø10 x 120	✓									
TFT	TFT06040	Ø6 x 40	✓	--	5,00	--	<u>12,53</u>	--	4,57	--	9,36
	TFT06050	Ø6 x 50	✓	--		--		--			
	TFT06060	Ø6 x 60	✓	13,87	5,00	<u>12,53</u>	<u>12,53</u>	9,71	4,57	11,17	9,36
TFP	TFP05040	Ø5 x 40	✓*	--	6,71	--	6,71	--	4,70	--	4,70
	TFP05060	Ø5 x 60	✓*	10,19	6,71	<u>8,19</u>	6,71	7,13	4,70	7,13	4,70
	TFP06040	Ø6 x 40	✓	--	5,00	--	<u>12,53</u>	9,71	4,57	--	9,36
	TFP06050	Ø6 x 50	✓	--		--				--	
	TFP06060	Ø6 x 60	✓	13,87	5,00	<u>12,53</u>	<u>12,53</u>	9,71	4,57	11,17	9,36
	TFP06080	Ø6 x 80	✓								
	TFP06100	Ø6 x 100	✓								
	TFP08060	Ø8 x 60	✓	--	11,30	--	<u>19,57</u>	--	7,91	--	14,23
TFP08080	Ø8 x 80	✓	17,65	11,30	<u>19,57</u>	<u>19,57</u>	12,36	7,91	15,69	14,23	
TFN	TFN14080	Ø14 x 80	✓	--	21,73	--	<u>52,72</u>	--	15,21	--	38,79
TFF	TFF05035S	Ø5 x 35 (M6)	✓*	--	6,71	--	--	--	4,70	--	--
	TFF06035	Ø6 x 35 (M8-M10)	✓	--	5,00	--	--	--	4,57	--	--
	TFF06040	Ø6 x 40 (M8-M10)	✓	--		--	--	--			
	TFF06055	Ø6 x 55 (M8-M10)	✓	13,87	--	--	--	9,71	--	--	--
	TFF08050T	Ø8 x 50 (M10)	✓	--	11,30	--	--	--	7,91	--	--
	TFF08050W	Ø8 x 50 (M12)	✓	--		--	--	--			
TFM	TFM06035	Ø6 x 35 (M8)	✓	--	5,00	--	--	--	4,57	--	--
	TFM06055	Ø6 x 55 (M10)	✓	13,87	--	--	--	9,71	--	--	--
TFS	TFS06100	Ø6 x 100 (M8)	✓	13,87	5,00	<u>12,53</u>	<u>12,53</u>	9,71	4,57	11,17	9,36
	TFS06120	Ø6 x 120 (M8)	✓								
	TFS08110	Ø8 x 110 (M10)	✓	17,65	11,30	<u>19,57</u>	<u>19,57</u>	12,36	7,91	15,69	14,23
	TFS08130	Ø8 x 130 (M10)	✓								
	TFS10120	Ø10 x 120 (M12)	✓								
TFS10140	Ø10 x 140 (M12)	✓	22,01	13,15	<u>27,40</u>	25,65	15,41	9,21	20,34	17,95	

Ø5 Zulassung nur für Verankerungen in Beton und vorgefertigten Spannbeton-Hohldecken für redundante nichttragende Systeme

6.2 BEMESSUNGSWERTE DER FESTIGKEIT (TRAGENDE ANWENDUNGEN)[kN]

Allgemeine Parameter				Ungerissener Beton				Gerissener Beton				
Familie	Artikelnr.	Größe	ETA-Zulassung	Zuglast $N_{Rd,ucr}$		Querlast $V_{Rd,ucr}$		Zuglast $N_{Rd,cr}$		Querlast $V_{Rd,cr}$		
				( $h_{ef,sta}$ )	( $h_{ef,red}$ )	( $h_{ef,sta}$ )	( $h_{ef,red}$ )	( $h_{ef,sta}$ )	( $h_{ef,red}$ )	( $h_{ef,sta}$ )	( $h_{ef,red}$ )	
TFE	TFE05040	Ø5 x 40	✓*	--	4,47	--	4,47	--	3,13	--	3,13	
	TFE05050	Ø5 x 50	✓*	6,79	4,47	<u>5,46</u>	4,47	4,75	3,13	4,75	3,13	
	TFE05060	Ø5 x 60	✓*									
	TFE05080	Ø5 x 80	✓*									
	TFE05100	Ø5 x 100	✓*									
	TFE06035	Ø6 x 35	✓	--	--	--	--	--	--	--	--	
	TFE06040	Ø6 x 40	✓	--	2,78	--	<u>8,35</u>	--	2,54	--	6,24	
	TFE06045	Ø6 x 45	✓	--		--		--				
	TFE06050	Ø6 x 50	✓	--		--		--				
	TFE06060	Ø6 x 60	✓	9,25	2,78	<u>8,35</u>	<u>8,35</u>	6,47	2,54	7,44	6,24	
	TFE06070	Ø6 x 70	✓									
	TFE06080	Ø6 x 80	✓									
	TFE06100	Ø6 x 100	✓									
	TFE06120	Ø6 x 120	✓	--	6,28	--	<u>13,05</u>	--	4,39	--	9,49	
	TFE08055	Ø8 x 55	✓	--		--		--				
	TFE08060	Ø8 x 60	✓	--		--		--				
	TFE08070	Ø8 x 70	✓	11,77		6,28		<u>13,05</u>		<u>13,05</u>		8,24
	TFE08075	Ø8 x 75	✓									
	TFE08080	Ø8 x 80	✓									
	TFE08090	Ø8 x 90	✓									
	TFE08100	Ø8 x 100	✓									
	TFE08110	Ø8 x 110	✓									
	TFE08120	Ø8 x 120	✓									
	TFE08140	Ø8 x 140	✓	--	8,77	--	17,10	--	6,14	--	11,97	
	TFE10060	Ø10 x 60	✓	--		--		--				
	TFE10070	Ø10 x 70	✓	--		--		--				
	TFE10080	Ø10 x 80	✓	--	17,99	8,77	<u>18,27</u>	17,10	12,59	6,14	<u>18,27</u>	11,97
	TFE10090	Ø10 x 90	✓									
	TFE10100	Ø10 x 100	✓									
	TFE10120	Ø10 x 120	✓									
	TFE10140	Ø10 x 140	✓									
	TFE10160	Ø10 x 160	✓									
TFE10180	Ø10 x 180	✓	--	14,49	--	<u>24,83</u>	--	10,14	--	23,63		
TFE12080	Ø12 x 80	✓	--		--		--					
TFE12090	Ø12 x 90	✓	--		--		--					
TFE12100	Ø12 x 100	✓	25,02	14,49	<u>24,83</u>	<u>24,83</u>	17,52	10,14	<u>24,83</u>	23,63		
TFE12110	Ø12 x 110	✓										
TFE12130	Ø12 x 130	✓										
TFE12150	Ø12 x 150	✓	--	21,73	--	<u>52,72</u>	--	15,21	--	38,79		
TFE14080	Ø14 x 80	✓	--		--		--					
TFE14100	Ø14 x 100	✓	--		--		--					
TFE14110	Ø14 x 110	✓	43,41	21,73	<u>52,72</u>	<u>52,72</u>	30,39	15,21	<u>52,72</u>	38,79		
TFE14120	Ø14 x 120	✓										
TFE14130	Ø14 x 130	✓										
TFE14140	Ø14 x 140	✓										
TFE14160	Ø14 x 160	✓	--	--	--	--	20,26	10,14	<u>38,65</u>	21,70		
TFE16100	Ø16 x 100	✓	--	--	--	--						
TFE16150	Ø16 x 150	✓	28,94	14,49	<u>38,65</u>	31,00	--	--	--	--		
TFE18100	Ø18 x 100	✓	--	19,00	--	50,54	--	13,30	--	35,38		
TFE18130	Ø18 x 130	✓	--		--		--		--			
TFE18160	Ø18 x 160	✓	38,87	19,00	<u>53,85</u>	50,54	27,21	13,30	<u>53,85</u>	35,38		
TFE18180	Ø18 x 180	✓										
TFE18200	Ø18 x 200	✓										

Allgemeine Parameter				Ungerissener Beton				Gerissener Beton			
Familie	Artikelnr.	Größe	ETA-Zulassung	Zuglast N <sub>Rd,ucr</sub>		Querlast V <sub>Rd,ucr</sub>		Zuglast N <sub>Rd,cr</sub>		Querlast V <sub>Rd,cr</sub>	
				(h <sub>ef,sta</sub> )	(h <sub>ef,red</sub> )	(h <sub>ef,sta</sub> )	(h <sub>ef,red</sub> )	(h <sub>ef,sta</sub> )	(h <sub>ef,red</sub> )	(h <sub>ef,sta</sub> )	(h <sub>ef,red</sub> )
TFA	TFA05040	Ø5 x 40	✓*	--	4,47	--	4,47	--	3,13	--	3,13
	TFA05060	Ø5 x 60	✓*	6,79	4,47	5,46	4,47	4,75	3,13	4,75	3,13
	TFA05080	Ø5 x 80	✓*								
	TFA05100	Ø5 x 100	✓*								
	TFA06045	Ø6 x 45	✓	--	2,78	--	8,35	--	2,54	--	6,24
	TFA06050	Ø6 x 50	✓	--		--		--			
	TFA06060	Ø6 x 60	✓	9,25	2,78	8,35	8,35	6,47	2,54	7,44	6,24
	TFA06080	Ø6 x 80	✓								
	TFA06100	Ø6 x 100	✓								
	TFA06120	Ø6 x 120	✓								
	TFA06140	Ø6 x 140	✓								
	TFA08060	Ø8 x 60	✓	--	6,28	--	13,05	--	4,39	--	9,49
	TFA08080	Ø8 x 80	✓	11,77	6,28	13,05	13,05	8,24	4,39	10,46	9,49
	TFA08100	Ø8 x 100	✓								
TFA08120	Ø8 x 120	✓									
TFA10100	Ø10 x 100	✓	17,99	8,77	18,27	17,10	12,59	6,14	18,27	11,97	
TFA10120	Ø10 x 120	✓									
TFT	TFT06040	Ø6 x 40	✓	--	2,78	--	8,35	--	2,54	--	6,24
	TFT06050	Ø6 x 50	✓	--		--		--			
	TFT06060	Ø6 x 60	✓	9,25	2,78	8,35	8,35	6,47	2,54	7,44	6,24
	TFT06080	Ø6 x 80	✓	9,25	2,78	8,35	8,35	6,47	2,54	7,44	6,24
TFT06100	Ø6 x 100	✓									
TFT06120	Ø6 x 120	✓									
TFP	TFP05040	Ø5 x 40	✓*	--	4,47	--	4,47	--	3,13	--	3,13
	TFP05060	Ø5 x 60	✓*	6,79	4,47	5,46	4,47	4,75	3,13	4,75	3,13
	TFP06040	Ø6 x 40	✓	--	2,78	--	8,35	--	2,54	--	6,24
	TFP06050	Ø6 x 50	✓	--		--		--			
	TFP06060	Ø6 x 60	✓	9,25	2,78	8,35	8,35	6,47	2,54	7,44	6,24
	TFP06080	Ø6 x 80	✓								
	TFP06100	Ø6 x 100	✓								
	TFP08060	Ø8 x 60	✓	--	6,28	--	13,05	--	4,39	--	9,49
TFP08080	Ø8 x 80	✓	11,77	6,28	13,05	13,05	8,24	4,39	10,46	9,49	
TFN	TFN14080	Ø14 x 80	✓	--	14,49	--	35,15	--	10,14	--	25,86
TFF	TFF05035S	Ø5 x 35 (M6)	✓*	--	4,47	--	--	--	3,13	--	--
	TFF06035	Ø6 x 35 (M8-M10)	✓	--	2,78	--	--	--	2,54	--	--
	TFF06040	Ø6 x 40 (M8-M10)	✓	--		--	--				
	TFF06055	Ø6 x 55 (M8-M10)	✓	9,25	--	--	--	6,47	--	--	--
	TFF08050T	Ø8 x 50 (M10)	✓	--	6,28	--	--	--	4,39	--	--
	TFF08050W	Ø8 x 50 (M12)	✓	--		--	--				
TFM	TFM06035	Ø6 x 35 (M8)	✓	--	2,78	--	--	--	2,54	--	--
	TFM06055	Ø6 x 55 (M10)	✓	9,25	--	--	--	6,47	--	--	--
TFS	TFS06100	Ø6 x 100 (M8)	✓	9,25	2,78	8,35	8,35	6,47	2,54	7,44	6,24
	TFS06120	Ø6 x 120 (M8)	✓								
	TFS08110	Ø8 x 110 (M10)	✓	11,77	6,28	13,05	13,05	8,24	4,39	10,46	9,49
	TFS08130	Ø8 x 130 (M10)	✓								
	TFS10120	Ø10 x 120 (M12)	✓								
	TFS10140	Ø10 x 140 (M12)	✓	14,67	8,77	18,27	17,10	10,27	6,14	13,56	11,97

Ø5 Zulassung nur für Verankerungen in Beton und vorgefertigten Spannbeton-Hohldecken für redundante nichttragende Systeme

**6.3 MAX. EMPFOHLENE ZUGFESTIGKEIT (TRAGENDE ANWENDUNGEN) [kN] (wenn  $\gamma_F=1,4$ ) [kN]**

Allgemeine Parameter				Ungerissener Beton				Gerissener Beton										
Familie	Artikelnr.	Größe	ETA-Zulassung	Zuglast $N_{rec,ucr}$		Querlast $V_{rec,ucr}$		Zuglast $N_{rec,cr}$		Querlast $V_{rec,cr}$								
				( $h_{ef,std}$ )	( $h_{ef,red}$ )	( $h_{ef,std}$ )	( $h_{ef,red}$ )	( $h_{ef,std}$ )	( $h_{ef,red}$ )	( $h_{ef,std}$ )	( $h_{ef,red}$ )							
TFE	TFE05040	Ø5 x 40	✓*	--	3,20	--	3,20	--	2,24	--	2,24							
	TFE05050	Ø5 x 50	✓*	4,85	3,20	<u>3,90</u>	3,20	3,40	2,24	3,40	2,24							
	TFE05060	Ø5 x 60	✓*															
	TFE05080	Ø5 x 80	✓*															
	TFE05100	Ø5 x 100	✓*															
	TFE06035	Ø6 x 35	✓	--	1,98	--	<u>5,97</u>	--	1,81	--	4,46							
	TFE06040	Ø6 x 40	✓															
	TFE06045	Ø6 x 45	✓															
	TFE06050	Ø6 x 50	✓															
	TFE06060	Ø6 x 60	✓	6,61	1,98	<u>5,97</u>	<u>5,97</u>	4,62	1,81	5,32	4,46							
	TFE06070	Ø6 x 70	✓															
	TFE06080	Ø6 x 80	✓															
	TFE06100	Ø6 x 100	✓															
	TFE06120	Ø6 x 120	✓	8,41	4,48	<u>9,32</u>	<u>9,32</u>	5,88	3,14	7,47	6,78							
	TFE08055	Ø8 x 55	✓															
	TFE08060	Ø8 x 60	✓															
	TFE08070	Ø8 x 70	✓															
	TFE08075	Ø8 x 75	✓	8,41	4,48	<u>9,32</u>	<u>9,32</u>	5,88	3,14	7,47	6,78							
	TFE08080	Ø8 x 80	✓															
	TFE08090	Ø8 x 90	✓															
	TFE08100	Ø8 x 100	✓															
	TFE08110	Ø8 x 110	✓	12,85	6,26	<u>13,05</u>	12,21	8,99	4,38	<u>13,05</u>	8,55							
	TFE08120	Ø8 x 120	✓															
	TFE08140	Ø8 x 140	✓															
	TFE10060	Ø10 x 60	✓															
	TFE10070	Ø10 x 70	✓	--	6,26	--	12,21	--	4,38	--	8,55							
	TFE10080	Ø10 x 80	✓															
	TFE10090	Ø10 x 90	✓															
	TFE10100	Ø10 x 100	✓															
	TFE10120	Ø10 x 120	✓	12,85	6,26	<u>13,05</u>	12,21	8,99	4,38	<u>13,05</u>	8,55							
	TFE10140	Ø10 x 140	✓															
	TFE10160	Ø10 x 160	✓															
TFE10180	Ø10 x 180	✓																
TFE12080	Ø12 x 80	✓	--	10,35	--	<u>17,73</u>	--	7,24	--	16,88								
TFE12090	Ø12 x 90	✓																
TFE12100	Ø12 x 100	✓																
TFE12110	Ø12 x 110	✓																
TFE12130	Ø12 x 130	✓	17,87	10,35	<u>17,73</u>	<u>17,73</u>	12,51	7,24	<u>17,73</u>	16,88								
TFE12150	Ø12 x 150	✓																
TFE14080	Ø14 x 80	✓									--	10,35	--	<u>25,10</u>	--	7,24	--	18,47
TFE14100	Ø14 x 100	✓																
TFE14110	Ø14 x 110	✓																
TFE14120	Ø14 x 120	✓																
TFE14130	Ø14 x 130	✓	20,67	10,35	<u>25,10</u>	<u>25,10</u>	14,47	7,24	<u>25,10</u>	18,47								
TFE14140	Ø14 x 140	✓																
TFE14160	Ø14 x 160	✓																
TFE16100	Ø16 x 100	✓									--	--	--	--	14,47	7,24	<u>27,60</u>	15,50
TFE16150	Ø16 x 150	✓	20,67	10,35	<u>27,60</u>	22,14												
TFE18100	Ø18 x 100	✓	--	13,57	--	36,10	--	9,50	--	25,27								
TFE18130	Ø18 x 130	✓																
TFE18160	Ø18 x 160	✓																
TFE18180	Ø18 x 180	✓	27,77		13,57		<u>38,47</u>		36,10		19,44	9,50	<u>38,47</u>	25,27				
TFE18200	Ø18 x 200	✓																



Allgemeine Parameter				Ungerissener Beton				Gerissener Beton										
Familie	Artikelnr.	Größe	ETA-Zulassung	Zuglast $N_{Rd, ucr}$		Querlast $V_{Rd, ucr}$		Zuglast $N_{Rd, cr}$		Querlast $V_{Rd, cr}$								
				( $h_{ef, std}$ )	( $h_{ef, red}$ )	( $h_{ef, std}$ )	( $h_{ef, red}$ )	( $h_{ef, std}$ )	( $h_{ef, red}$ )	( $h_{ef, std}$ )	( $h_{ef, red}$ )							
TFA	TFA05040	Ø5 x 40	✓*	--	3,20	--	3,20	--	2,24	--	2,24							
	TFA05060	Ø5 x 60	✓*	4,85	3,20	<u>3,90</u>	3,20	3,40	2,24	3,40	2,24							
	TFA05080	Ø5 x 80	✓*															
	TFA05100	Ø5 x 100	✓*															
	TFA06045	Ø6 x 45	✓	--	1,98	--	<u>5,97</u>	--	1,81	--	4,46							
	TFA06050	Ø6 x 50	✓															
	TFA06060	Ø6 x 60	✓	6,61	1,98	<u>5,97</u>	<u>5,97</u>	4,62	1,81	5,32	4,46							
	TFA06080	Ø6 x 80	✓															
	TFA06100	Ø6 x 100	✓															
	TFA06120	Ø6 x 120	✓															
	TFA06140	Ø6 x 140	✓	8,41	4,48	<u>9,32</u>	<u>9,32</u>	5,88	3,14	7,47	6,78							
	TFA08060	Ø8 x 60	✓															
	TFA08080	Ø8 x 80	✓															
	TFA08100	Ø8 x 100	✓															
TFA08120	Ø8 x 120	✓	12,85	6,26	<u>13,05</u>	12,21	8,99	4,38	<u>13,05</u>	8,55								
TFA10100	Ø10 x 100	✓																
TFA10120	Ø10 x 120	✓																
TFT	TFT06040	Ø6 x 40	✓	--	1,98	--	<u>5,97</u>	--	1,81	--	4,46							
	TFT06050	Ø6 x 50	✓															
	TFT06060	Ø6 x 60	✓	6,61	1,98	<u>5,97</u>	<u>5,97</u>	4,62	1,81	5,32	4,46							
	TFT06080	Ø6 x 80	✓	8,41	4,48	<u>9,32</u>	<u>9,32</u>	5,88	3,14	7,47	6,78							
TFT06100	Ø6 x 100	✓																
TFT06040	Ø6 x 40	✓*	--									3,20	--	3,20	--	2,24	--	2,24
TFT06060	Ø6 x 60	✓*	4,85									3,20	<u>3,90</u>	3,20	3,40	2,24	3,40	2,24
TFP	TFP06040	Ø6 x 40	✓	--	1,98	--	<u>5,97</u>	--	1,81	--	4,46							
	TFP06050	Ø6 x 50	✓															
	TFP06060	Ø6 x 60	✓	6,61	1,98	<u>5,97</u>	<u>5,97</u>	4,62	1,81	5,32	4,46							
	TFP06080	Ø6 x 80	✓	8,41	4,48	<u>9,32</u>	<u>9,32</u>	5,88	3,14	7,47	6,78							
	TFP06100	Ø6 x 100	✓															
	TFP08060	Ø8 x 60	✓															
	TFP08080	Ø8 x 80	✓															
TFN	TFN14080	Ø14 x 80	✓	--	10,35	--	25,10	--	7,24	--	18,47							
TFF	TFF05035S	Ø5 x 35 (M6)	✓*	--	3,20	--	--	--	2,24	--	--							
	TFF06035	Ø6 x 35 (M8-M10)	✓	--	1,98	--	--	--	1,81	--	--							
	TFF06040	Ø6 x 40 (M8-M10)	✓															
	TFF06055	Ø6 x 55 (M8-M10)	✓	6,61	--	--	--	4,62	--	--	--							
	TFF08050T	Ø8 x 50 (M10)	✓	--	4,48	--	<u>9,32</u>	--	3,14	--	--							
	TFF08050W	Ø8 x 50 (M12)	✓															
TFM	TFM06035	Ø6 x 35 (M8)	✓	--	1,98	--	--	--	1,81	--	--							
	TFM06055	Ø6 x 55 (M10)	✓	6,61	--	--	--	4,62	--	--	--							
TFS	TFS06100	Ø6 x 100 (M8)	✓	6,61	1,98	<u>5,97</u>	<u>5,97</u>	4,62	1,81	5,32	4,46							
	TFS06120	Ø6 x 120 (M8)	✓															
	TFS08110	Ø8 x 110 (M10)	✓	8,41	4,48	<u>9,32</u>	<u>9,32</u>	5,88	3,14	7,47	6,78							
	TFS08130	Ø8 x 130 (M10)	✓															
	TFS10120	Ø10 x 120 (M12)	✓															
	TFS10140	Ø10 x 140 (M12)	✓															

\*Ø5 Zulassung nur für Verankerungen in Beton und vorgefertigten Spannbeton-Hohldecken für redundante nichttragende Systeme

VERGRÖßERUNGSFAKTOREN FÜR HERAUSZIEHEN UNTER ZUGBEANSPRUCHUNG FÜR HOCHFESTEN BETON $\psi_c$															
Durchmesser	Ø5		Ø6		Ø8		Ø10			Ø12		Ø14		Ø18	
Einbautiefe	( $h_{ef, red}$ )	( $h_{ef, std}$ )	( $h_{ef, red}$ )	( $h_{ef, std}$ )	( $h_{ef, red}$ )	( $h_{ef, std}$ )	( $h_{ef, 1}$ )	( $h_{ef, 2}$ )	( $h_{ef, 3}$ )	( $h_{ef, red}$ )	( $h_{ef, std}$ )	( $h_{ef, red}$ )	( $h_{ef, std}$ )	( $h_{ef, red}$ )	( $h_{ef, std}$ )
C30/37	1,00	1,00	1,16	1,22	1,21	1,22	1,22	1,17	1,22	1,16	1,22	1,21	1,20	1,22	1,17
C40/50	1,00	1,00	1,28	1,41	1,39	1,41	1,41	1,30	1,41	1,29	1,41	1,39	1,37	1,40	1,32
C50/60	1,00	1,00	1,39	1,58	1,54	1,58	1,58	1,42	1,58	1,40	1,58	1,55	1,51	1,57	1,42

## 7. TRAGFÄHIGKEIT

Die Tragfähigkeitswerte in Hohlkörperplatten C30/37 für eine einzelne Verankerung ohne Einwirkung von Rand- oder Achsabstand-Effekten werden in der nachfolgenden Tabelle angegeben:

Unterstrichene und kursiv gedruckte Werte geben das Stahlversagen an; die **fett** gedruckten Werte geben das Versagen durch Betonausbruch und die restlichen das Versagen durch Herausziehen an.

1 KN ≈ 100 kg

### 7.1 CHARAKTERISTISCHE FESTIGKEIT (NICHT TRAGENDE ANWENDUNGEN)[kN]

Allgemeine Parameter				Hohlkörperplatten						
Familie	Artikelnr.	Größe	ETA-Zulassung	Zuglast N <sub>Rk</sub>			Querlast V <sub>Rk</sub>			
				(h <sub>ef1</sub> )	(h <sub>ef2</sub> )	(h <sub>ef3</sub> )	(h <sub>ef1</sub> )	(h <sub>ef2</sub> )	(h <sub>ef3</sub> )	
TFE	TFE05040	Ø5 x 40	✓*	5,39	--	--	5,39	--	--	
	TFE05050	Ø5 x 50	✓*							
	TFE05060	Ø5 x 60	✓*			6,22		8,22	6,22	<u>8,19</u>
	TFE05080	Ø5 x 80	✓*							
	TFE05100	Ø5 x 100	✓*							
	TFE06035	Ø6 x 35	✓	5,39	--	--	5,39	--	--	
	TFE06040	Ø6 x 40	✓			--		--	--	--
	TFE06045	Ø6 x 45	✓							--
	TFE06050	Ø6 x 50	✓							
	TFE06060	Ø6 x 60	✓			6,22		7,99	6,22	7,99
	TFE06070	Ø6 x 70	✓							
	TFE06080	Ø6 x 80	✓							
	TFE06100	Ø6 x 100	✓							
	TFE06120	Ø6 x 120	✓							
TFA05040	Ø5 x 40	✓*	5,39		--	--		5,39	--	--
TFA05060	Ø5 x 60	✓*								
TFA05080	Ø5 x 80	✓*			6,22	8,22	6,22		<u>8,19</u>	
TFA05100	Ø5 x 100	✓*								
TFA06045	Ø6 x 45	✓	5,39		--	5,39		--		
TFA06050	Ø6 x 50	✓			--		--		--	
TFA06060	Ø6 x 60	✓								
TFA06080	Ø6 x 80	✓			6,22		7,99	6,22	7,99	
TFA06100	Ø6 x 100	✓								
TFA06120	Ø6 x 120	✓								
TFA06140	Ø6 x 140	✓								
TFT06040	Ø6 x 40	✓		5,39	--		--	5,39	--	--
TFT06050	Ø6 x 50	✓			6,22	7,99	6,22		7,99	
TFT06060	Ø6 x 60	✓								
THP	TFP05040	Ø5 x 40	✓*	5,39	--	--	5,39	--	--	
	TFP05060	Ø5 x 60	✓*			6,22		8,22	6,22	<u>8,19</u>
	TFP06040	Ø6 x 40	✓	5,39	--	--	5,39	--	--	
	TFP06050	Ø6 x 50	✓							
	TFP06060	Ø6 x 60	✓			6,22		7,99	6,22	7,99
	TFP06080	Ø6 x 80	✓							
	TFP06100	Ø6 x 100	✓							
TFF	TFF05035S	Ø5 x 35 (M6)	✓*	5,39	6,22	8,22	5,39	6,22	<u>8,19</u>	
	TFF06035	Ø6 x 35 (M8-M10)	✓	5,39			5,39			
	TFF06040	Ø6 x 40 (M8-M10)	✓			6,22		7,99	6,22	7,99
	TFF06055	Ø6 x 55 (M8-M10)	✓							
TFM	TFM06035	Ø6 x 35 (M8)	✓	5,39		7,99	5,39	6,22	7,99	
	TFM06055	Ø6 x 55 (M10)	✓			6,22			6,22	7,99
TFS	TFS06100	Ø6 x 100 (M8)	✓	5,39		7,99	5,39	6,22	7,99	
	TFS06120	Ø6 x 120 (M8)	✓			6,22			6,22	7,99

\*Ø5 Zulassung nur für Verankerungen in Beton und vorgefertigten Spannbeton-Hohldecken für redundante nichttragende Systeme

7.2 BEMESSUNGSWERTE DER FESTIGKEIT (NICHT TRAGENDE ANWENDUNGEN) [kN]									
Allgemeine Parameter				Hohlkörperplatten					
Familie	Artikelnr.	Größe	ETA-Zulassung	Zuglast $N_{Rd}$			Querlast $V_{Rd}$		
				( $h_{ef1}$ )	( $h_{ef2}$ )	( $h_{ef3}$ )	( $h_{ef1}$ )	( $h_{ef2}$ )	( $h_{ef3}$ )
TFE	TFE05040	Ø5 x 40	✓*	2,99	--	--	3,59	--	--
	TFE05050	Ø5 x 50	✓*		--	--		--	--
	TFE05060	Ø5 x 60	✓*		3,45	4,57		4,14	5,46
	TFE05080	Ø5 x 80	✓*						
	TFE05100	Ø5 x 100	✓*						
	TFE06035	Ø6 x 35	✓	2,99	--	--	3,59	--	--
	TFE06040	Ø6 x 40	✓		--	--		--	--
	TFE06045	Ø6 x 45	✓						
	TFE06050	Ø6 x 50	✓						
	TFE06060	Ø6 x 60	✓		3,45	4,44		4,14	5,33
	TFE06070	Ø6 x 70	✓						
	TFE06080	Ø6 x 80	✓						
	TFE06100	Ø6 x 100	✓						
TFE06120	Ø6 x 120	✓							
TFA	TFA05040	Ø5 x 40	✓*	2,99	--	--	3,59	--	--
	TFA05060	Ø5 x 60	✓*		3,45	4,57		4,14	5,46
	TFA05080	Ø5 x 80	✓*						
	TFA05100	Ø5 x 100	✓*						
	TFA06045	Ø6 x 45	✓	2,99		--	3,59		--
	TFA06050	Ø6 x 50	✓			--			--
	TFA06060	Ø6 x 60	✓						
	TFA06080	Ø6 x 80	✓		3,45	4,44		4,14	5,33
	TFA06100	Ø6 x 100	✓						
	TFA06120	Ø6 x 120	✓						
THT	TFT06040	Ø6 x 40	✓	2,99	--	--	3,59	--	--
	TFT06050	Ø6 x 50	✓		3,45	4,44		4,14	5,33
	TFT06060	Ø6 x 60	✓						
THP	TFP05040	Ø5 x 40	✓*	2,99	--	--	3,59	--	--
	TFP05060	Ø5 x 60	✓*		3,45	4,57		4,14	5,46
	TFP06040	Ø6 x 40	✓	2,99	--	--	3,59	--	--
	TFP06050	Ø6 x 50	✓						
	TFP06060	Ø6 x 60	✓		3,45	4,44		4,14	5,33
	TFP06080	Ø6 x 80	✓						
	TFP06100	Ø6 x 100	✓						
TFF	TFF05035S	Ø5 x 35 (M6)	✓*	2,99	6,22	8,22	3,59	4,14	5,46
	TFF06035	Ø6 x 35 (M8-M10)	✓	2,99			3,59		
	TFF06040	Ø6 x 40 (M8-M10)	✓		3,45	4,44		4,14	5,33
	TFF06055	Ø6 x 55 (M8-M10)	✓						
TFM	TFM06035	Ø6 x 35 (M8)	✓	2,99			3,59		
	TFM06055	Ø6 x 55 (M10)	✓		3,45	4,44		4,14	5,33
TFS	TFS06100	Ø6 x 100 (M8)	✓	2,99			3,59		
	TFS06120	Ø6 x 120 (M8)	✓		3,45	4,44		4,14	5,33

\*Ø5 Zulassung nur für Verankerungen in Beton und vorgefertigten Spannbeton-Hohldecken für redundante nichttragende Systeme

**7.3 MAX. EMPFOHLENE ZUGFESTIGKEIT (NICHT TRAGENDE ANWENDUNGEN) [kN] (wenn  $\gamma_F= 1,4$  ) [kN]**

Allgemeine Parameter				Hohlkörperplatten					
Familie	Artikelnr.	Größe	ETA-Zulassung	Zuglast $N_{rec}$			Querlast $V_{rec}$		
				( $h_{ef1}$ )	( $h_{ef2}$ )	( $h_{ef3}$ )	( $h_{ef1}$ )	( $h_{ef2}$ )	( $h_{ef3}$ )
TFE	TFE05040	Ø5 x 40	✓*	2,14	--	--	2,57	--	--
	TFE05050	Ø5 x 50	✓*		--	--		--	--
	TFE05060	Ø5 x 60	✓*		2,47	3,26		2,96	3,90
	TFE05080	Ø5 x 80	✓*						
	TFE05100	Ø5 x 100	✓*	2,14	--	--	2,57	--	--
	TFE06035	Ø6 x 35	✓		--	--		--	--
	TFE06040	Ø6 x 40	✓		2,47	3,17		2,96	3,80
	TFE06045	Ø6 x 45	✓						
	TFE06050	Ø6 x 50	✓						
	TFE06060	Ø6 x 60	✓						
	TFE06070	Ø6 x 70	✓						
	TFE06080	Ø6 x 80	✓						
	TFE06100	Ø6 x 100	✓						
TFE06120	Ø6 x 120	✓							
TFA	TFA05040	Ø5 x 40	✓*	2,14	--	--	2,57	--	--
	TFA05060	Ø5 x 60	✓*		2,47	3,26		2,96	3,90
	TFA05080	Ø5 x 80	✓*						
	TFA05100	Ø5 x 100	✓*						
	TFA06045	Ø6 x 45	✓	2,14	--	--	2,57	--	--
	TFA06050	Ø6 x 50	✓		2,47	3,17		2,96	3,80
	TFA06060	Ø6 x 60	✓						
	TFA06080	Ø6 x 80	✓						
	TFA06100	Ø6 x 100	✓						
	TFA06120	Ø6 x 120	✓						
THT	TFT06040	Ø6 x 40	✓	2,14	--	--	2,57	--	--
	TFT06050	Ø6 x 50	✓		2,47	3,17		2,96	3,80
	TFT06060	Ø6 x 60	✓						
THP	TFP05040	Ø5 x 40	✓*	2,14	--	--	2,57	--	--
	TFP05060	Ø5 x 60	✓*		2,47	3,26		2,96	3,90
	TFP06040	Ø6 x 40	✓	2,14	--	--	2,57	--	--
	TFP06050	Ø6 x 50	✓		2,47	3,17		2,96	3,80
	TFP06060	Ø6 x 60	✓						
	TFP06080	Ø6 x 80	✓						
	TFP06100	Ø6 x 100	✓						
TFF	TFF05035S	Ø5 x 35 (M6)	✓*	2,14	2,47	3,26	2,57	2,96	3,90
	TFF06035	Ø6 x 35 (M8-M10)	✓	2,14	2,47	3,17	2,57	2,96	3,80
	TFF06040	Ø6 x 40 (M8-M10)	✓						
	TFF06055	Ø6 x 55 (M8-M10)	✓						
TFM	TFM06035	Ø6 x 35 (M8)	✓	2,14	2,47	3,17	2,57	2,96	3,80
	TFM06055	Ø6 x 55 (M10)	✓						
TFS	TFS06100	Ø6 x 100 (M8)	✓	2,14	2,47	3,17	2,57	2,96	3,80
	TFS06120	Ø6 x 120 (M8)	✓						

\*Ø5 Zulassung nur für Verankerungen in Beton und vorgefertigten Spannbeton-Hohldecken für redundante nichttragende Systeme

## 6. OFFIZIELLE DOKUMENTE

Bei unserer Vertriebsabteilung oder über unsere Website [www.indexfix.com](http://www.indexfix.com) können Sie folgende Dokument erhalten:

- EU-Zulassung ETA 20/0046 für den Einbau in gerissenem und ungerissenem Beton gemäß EAD 330232- 01-0601, Option 1, von  $\varnothing 6$  bis  $\varnothing 18$ .
- Europäische Zulassung ETA 20/0494 für die Verwendung in Beton- und Fertigteil-Hohlkörperplatten für redundante nichttragende Systeme gemäß EAD-Richtlinie 330747-00-0601 von  $\varnothing 5$  bis  $\varnothing 6$ .
- Leistungserklärung DoP THE.
- Erfüllt die Richtlinie VdS CEA 4001:2021-01(07) „Richtlinien für Sprinkleranlagen. Planung und Einbau für Anwendungen von Wasserlöschanlagen auf Betonelementen“ von  $\varnothing 8$  bis  $\varnothing 18$ .
- Erhältlich für das Berechnungsprogramm für Verankerungen INDEXcal.