

## MO-PS+ / MO-PSP+

## CERTIFICATES



## BASE MATERIAL



## CHARACTERISTICS

- Assessed for structural applications in non-cracked concrete M8-M24.
- Assessed for use in masonry.
- LEED and A+ certificates, Styrene free.
- Use for medium-high loads, static or quasi-static.
- Working life of 50 and/or 100 years.
- Working time indicator.
- Valid for dry, wet and flooded holes.
- Valid for zinc plated steel, hot-dip galvanized, stainless steel A2, A4 and HCR.
- Temperature range: from -40°C to +80°C (long term maximum temperature +50°C).

## VALID FOR



## APPLICATIONS

- Use in indoor and outdoor environments.
- Structural applications.
- Fixing of building substructures.
- Rehabilitation of facades.
- For fixing air conditioning supports, boilers, awnings, garage door frames, signs, balconies, shelving units, railings, handrails, etc.

## DRILL HOLE CONDITION

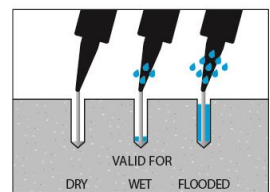

## APPLICATION EXAMPLES



## MAXIMUM LOAD RECOMMENDED [kg]

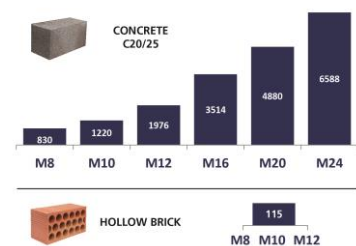

**1. RANGE**



ITEM	CODE	SIZE	PHOTO	COMPONENT	MATERIAL	
1	<b>MOPS300</b> <b>MOPS410</b>	300 ml. 410 ml.		STYRENE FREE POLYESTER MORTAR	Styrene free polyester. Format: cartridges de 300 y 410 ml	12
2	<b>MOPSP300</b> <b>MOPSP410</b>	300 ml. 410 ml.		STYRENE FREE POLYESTER MORTAR STONE VERSION	Styrene free polyester colored stone. Format: 300 and 410 ml cartridges	12

**2. ACCESSORIES**

ITEM	CODE	PHOTO	COMPONENT	MATERIAL
1	<b>MOPISSI</b>		APPLICATION GUNS	Gun for 300 ml standard cartridges
	<b>MOPISTO</b>			Gun for 410 ml coaxial cartridges
2	<b>EQ-AC</b> <b>EQ-8.8</b> <b>EQ-A2</b> <b>EQ-A4</b>		STUD BOLTS	Threaded steel stud, class 5.8 ISO 898-1 Threaded steel stud, class 8.8 ISO 898-1 Threaded stainless steel stud A2-70 Threaded stainless steel stud A4-70
3	<b>MORCEPKIT</b>		CLEANING BRUSHES	3 Cleaning brushes kit of $\varnothing 14$ , $\varnothing 20$ and $\varnothing 29$ mm.
4	<b>MOBOMBA</b>		CLEANING PUMP	Pump for cleaning dust and drill hole fragments
5	<b>MORCANU</b>		MIXING NOZZLE	Plastic. Helix static mixer.
6	<b>MO-TN</b>		NYLON SLEEVE	Plastic. Available in white and grey
7	<b>MO-TR</b>		METAL THREADED SLEEVE	Metal threaded sleeve M8, M10, M12, zinc plated.
8	<b>MO-TM</b>		METAL SLEEVE	Metal sleeve of $\varnothing 12$ , $\varnothing 16$ and $\varnothing 22$ ,

### 3. INSTALLATION DATA

#### 3.1. CONCRETE FIXING (SET UP PARAMETERS)

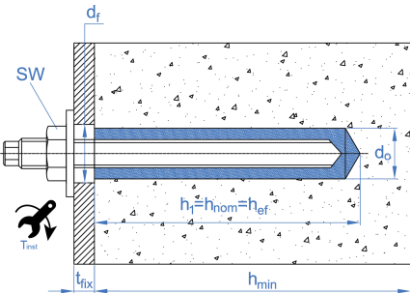
SIZE		M8	M10	M12	M16	M20	M24
$d_0$ : nominal diameter	[mm]	10	12	14	18	22	26
$d_f$ : fixture hole diameter $\leq$	[mm]	9	12	14	18	22	26
$T_{ins}$ : torque $\leq$	[Nm]	10	20	40	80	150	200
Circular cleaning brush diameter		$\varnothing 14$		$\varnothing 20$		$\varnothing 29$	
<b><math>h_{ef,min}</math></b>							
$h_1$ : drill hole depth	[mm]	64	80	96	128	160	192
$s_{cr,N}$ : critical spacing	[mm]	192	240	288	384	480	576
$c_{cr,N}$ : critical edge distance	[mm]	96	120	144	192	240	288
$c_{min}$ : minimum distance to edge	[mm]	35	40	50	65	80	96
$s_{min}$ : minimum spacing	[mm]	35	40	50	65	80	96
$h_{min}$ : minimum concrete thickness	[mm]	100	110	126	158	204	244
<b>Standard stud</b>							
$h_1$ : drill hole depth	[mm]	80	90	110	128	170	210
$s_{cr,N}$ : critical spacing	[mm]	240	270	330	384	510	630
$c_{cr,N}$ : critical edge distance	[mm]	120	135	165	192	255	315
$c_{min}$ : minimum distance to edge	[mm]	43	45	56	65	85	105
$s_{min}$ : minimum spacing	[mm]	43	45	56	65	85	105
$h_{min}$ : minimum concrete thickness	[mm]	110	120	140	158	214	262
<b><math>h_{ef,max}</math></b>							
$h_1$ : drill hole depth	[mm]	96	120	144	192	240	288
$s_{cr,N}$ : critical spacing	[mm]	288	360	432	576	720	864
$c_{cr,N}$ : critical edge distance	[mm]	144	180	216	288	360	432
$c_{min}$ : minimum distance to edge	[mm]	50	60	70	95	120	145
$s_{min}$ : minimum spacing	[mm]	50	60	70	95	120	145
$h_{min}$ : minimum concrete thickness	[mm]	126	150	174	222	284	340
5.8 / 8.8 Zinc plated stud code 		EQAC08110 EQ8808110	EQAC10130 EQ8810130	EQAC12160 EQ8812160	EQAC16190 EQ8816190	EQAC20260 EQ8820260	EQAC24300 EQ8824300
A2 / A4 Stainless steel stud code 		EQA208110 EQA408110	EQA210130 EQA410130	EQA212160 EQA412160	EQA216190 EQA416190	EQA220260 EQA420260	EQA224300 EQA424300
		<ul style="list-style-type: none"> <li><math>h_{ef}</math> depth value may be selected by the user ranging between <math>h_{ef,min} = 8d</math> and <math>h_{ef,max} = 12d</math>. Any intermediate values may be interpolated.</li> <li>Critical distances are those where anchors in a group of anchors are not influenced by one another with regard to tension load effects. For smaller distances, down to minimum distances, corresponding reduction coefficients must be applied.</li> <li>Standard studs are available for each measurement, as shown in the table.</li> </ul>					

## 3.2. FIXING IN MASONRY

### 3.2.1 SET UP PARAMETERS

BASE MATERIAL		Bricks N°1 - 12									Brick N°13		Bricks N°14 - 16			
ANCHOR TYPE		Threaded rod without sleeve <sup>1</sup>			Threaded rod with sleeve			Internal threaded socket with sleeve			Threaded rod with sleeve		Threaded rod without sleeve			
SIZE		M8	M10	M12	M8	M10	M12	M8	M10	M12	M6	M8	M6	M8	M10	M12
Plastic sleeve length	[mm]	--	--	--	85	85	85	85	85	85	80	80	--	--	--	--
Plastic sleeve diameter	[mm]	--	--	--	15/16	15/16	20	15/16	20	20	12	12	--	--	--	--
Internal threaded socket	[mm]	--	--	--	--	--	--	12 x 80	14 x 80	16 x 80	--	--	--	--	--	--
Volume per hole/sleeve	[ml]	15	15	27	15	15	27	15	15	27	10	10	10	15	15	27
d <sub>0</sub> : Drill bit diameter	[mm]	15	15	20	15/16	15/16	20	15/16	20	20	12	12	8	10	12	14
h <sub>1</sub> : drill hole depth ≥	[mm]	90	90	90	90	90	90	90	90	90	85	85	80	80	80	95
h <sub>ef</sub> : effective depth ≥	[mm]	85	85	85	85	85	85	80	80	80	80	80	75	75	75	90
h <sub>min</sub> : base material thickness ≥	[mm]	120	120	120	120	120	120	120	120	120	115	115	110	110	110	125
d <sub>f</sub> : Diameter of clearance hole in the fixture ≤	[mm]	9	12	14	9	12	14	9	12	14	9	9	7	9	12	14
T <sub>ins</sub> : torque ≤	[Nm]	2	2	2	2	2	2	2	2	2	2	2	2	2	2	2

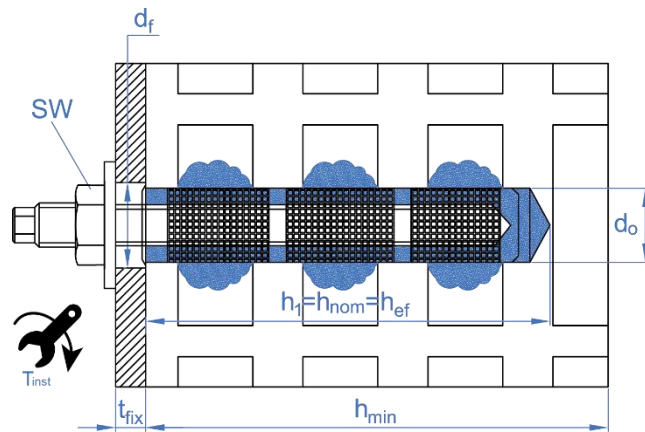

In order to make fixations in hollow bricks a nylon sleeve should be used to prevent the resin from falling through the inner holes. In some cases, to perform installations in bricks where a stud is required to be threaded, a metal sleeve with an internal thread can be used for fixing. In this case, the metal sleeve with internal thread must be inside a plastic.



<sup>1</sup> Valid only for solid bricks

## 3.2.2 EDGE DISTANCES AND SPACING BETWEEN ANCHORS

BASE MATERIAL		SOLID OR HOLLOW BRICK									SOLID OR HOLLOW BRICK									AERATED CONCRETE						
ANCHOR TYPE		Threaded rod with or without sleeve									Internal threaded socket with sleeve									Threaded rod without sleeve						
SIZE		(M6) <sup>2</sup> M8			M10			M12			M8			M10			M12			M6 / M8 / M10			M12			
Critical/Minimum spacing and edge distance		$C_{cr}$	$S_{cr II}$	$S_{min \perp}$	$C_{cr}$	$S_{cr II}$	$S_{min \perp}$	$C_{cr}$	$S_{cr II}$	$S_{min \perp}$	$C_{cr}$	$S_{cr II}$	$S_{min \perp}$	$C_{cr}$	$S_{cr II}$	$S_{min \perp}$	$C_{cr}$	$S_{cr II}$	$S_{min \perp}$	$C_{cr}$	$S_{cr II}$	$S_{min \perp}$	$C_{cr}$	$S_{cr II}$	$S_{min \perp}$	
Brick number 1	[mm]	100	235	115	100	235	115	120	235	115	100	235	115	120	235	115	120	235	115	--	--	--	--	--	--	
Brick number 2	[mm]	100	240	113	100	240	113	120	240	113	100	240	113	120	240	113	120	240	113	--	--	--	--	--	--	
Brick number 3	[mm]	100	237	237	100	237	237	120	250	237	--	--	--	120	250	237	120	250	237	--	--	--	--	--	--	
Brick number 4	[mm]	128	255	255	128	255	255	128	255	255	128	255	255	128	255	255	128	255	255	--	--	--	--	--	--	
Brick number 5	[mm]	128	255	255	128	255	255	128	255	255	128	255	255	128	255	255	128	255	255	--	--	--	--	--	--	
Brick number 6	[mm]	100	250	240	100	250	240	120	250	240	100	250	240	120	250	240	120	250	240	--	--	--	--	--	--	
Brick number 7	[mm]	100	250	248	100	250	248	--	--	--	100	250	248	120	250	248	120	250	248	--	--	--	--	--	--	
Brick number 8	[mm]	100	250	248	100	250	248	120	250	248	--	--	--	120	250	248	120	250	248	--	--	--	--	--	--	
Brick number 9	[mm]	100	370	238	100	370	238	120	370	238	100	370	238	120	370	238	120	370	238	--	--	--	--	--	--	
Brick number 10	[mm]	100	245	110	100	245	110	120	245	110	--	--	--	--	--	--	--	--	--	--	--	--	--	--	--	
Brick number 11	[mm]	100	373	238	100	373	238	120	373	238	--	--	--	--	--	--	--	--	--	--	--	--	--	--	--	
Brick number 12	[mm]	100	400	200	--	--	--	120	400	200	--	--	--	--	--	--	--	--	--	--	--	--	--	--	--	
Brick number 13	[mm]	100	245	110	--	--	--	--	--	--	--	--	--	--	--	--	--	--	--	--	--	--	--	--	--	
Brick number 14	[mm]	--	--	--	--	--	--	--	--	--	--	--	--	--	--	--	--	--	--	--	113	225	225	135	270	270
Brick number 15	[mm]	--	--	--	--	--	--	--	--	--	--	--	--	--	--	--	--	--	--	--	113	225	225	135	270	270
Brick number 16	[mm]	--	--	--	--	--	--	--	--	--	--	--	--	--	--	--	--	--	--	--	113	225	225	135	270	270

<sup>2</sup> Valid only for installation in brick N°13

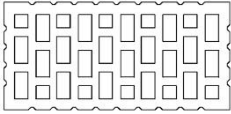
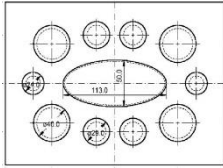
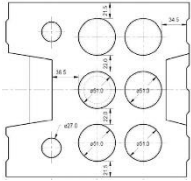
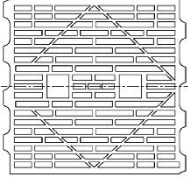
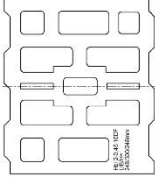
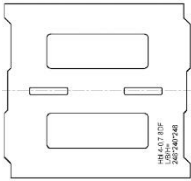
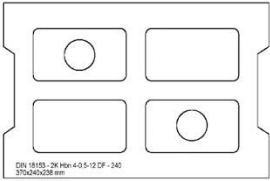
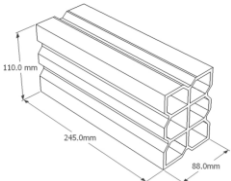
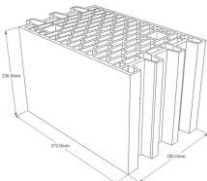
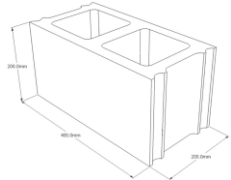
BRICK TYPES

<p><b>Brick nº 1</b> Hollow clay brick HLz 12-1, 0-2DF according to EN 771-1 Length / width / height: 235 mm / 112 mm / 115 mm <math>f_b \geq 12 \text{ N/mm}^2 / \rho \geq 1,0 \text{ kg/dm}^3</math></p>		<p><b>Brick nº 2</b> Hollow sillico calcareous brick KSL 12-1, 4-3DF according to EN 771-2 Length / width / height: 240 mm / 175 mm / 113 mm <math>f_b \geq 12 \text{ N/mm}^2 / \rho \geq 1,4 \text{ kg/dm}^3</math></p>	
<p><b>Brick nº 3</b> Hollow sillico calcareous brick KSL 12-1, 4-2DF according to EN 771-2 Length / width / height: 250 mm / 240 mm / 237 mm <math>f_b \geq 12 \text{ N/mm}^2 / \rho \geq 1,4 \text{ kg/dm}^3</math></p>		<p><b>Brick nº 4</b> Solid clay brick Mz 12-2, 0-NF according to EN 771-1. Length / width / height: 240 mm / 116 mm / 71 mm <math>f_b \geq 12 \text{ N/mm}^2 / \rho \geq 2,0 \text{ kg/dm}^3</math></p>	<p><b>Brick nº 5</b> Solid sillico calcareous brick KS 12-2, 0-NF according to EN 771-2. Length / width / height: 240 mm / 115 mm / 70 mm <math>f_b \geq 12 \text{ N/mm}^2 / \rho \geq 2,0 \text{ kg/dm}^3</math></p>
<p><b>Brick nº 6</b> Hollow baked clay brick HLzW 6- 0,7-8DF according to EN 771-1 Length / width / height: 250 mm / 240 mm / 240 mm <math>f_b \geq 6 \text{ N/mm}^2 / \rho \geq 0,8 \text{ kg/dm}^3</math></p>		<p><b>Brick nº 7</b> Hollow lightweight concrete block Hbl 2-0,45-10DF according to EN 771-3 Length / width / height: 250 mm / 300 mm / 248 mm <math>f_b \geq 2,0 \text{ N/mm}^2 / \rho \geq 0,45 \text{ kg/dm}^3</math></p>	
<p><b>Brick nº 8</b> Hollow lightweight concrete block Hbl 4-0, 7-8DF according to EN 771-3 Length / width / height: 250 mm / 240 mm / 248 mm <math>f_b \geq 4,0 \text{ N/mm}^2 / \rho \geq 0,7 \text{ kg/dm}^3</math></p>		<p><b>Brick nº 9</b> Concrete block Hbn 4-12DF according to EN 771-3 Length / width / height: 370 mm / 240 mm / 238 mm <math>f_b \geq 4 \text{ N/mm}^2 / \rho \geq 1,2 \text{ kg/dm}^3</math></p>	
<p><b>Brick nº 10</b> Hollow clay brick Hueco Doble according to EN 771-1 Length / width / height: 245 mm / 110 mm / 88 mm <math>f_b \geq 2,5 \text{ N/mm}^2 / \rho \geq 0,74 \text{ kg/dm}^3</math></p>		<p><b>Brick nº 11</b> Hollow clay brick Porotherm 25 P+W KL15 according to EN 771-1 Length / width / height: 373 mm / 250 mm / 238 mm <math>f_b \geq 12 \text{ N/mm}^2 / \rho \geq 0,9 \text{ kg/dm}^3</math></p>	
<p><b>Brick nº 12</b> Concrete hollow block, Bloque hornigón according to EN 771-3 Length / width / height: 400 mm / 200 mm / 200 mm <math>f_b \geq 2,5 \text{ N/mm}^2 / \rho \geq 1,7 \text{ kg/dm}^3</math></p>		<p><b>Brick nº 13*</b> Perforated clay brick PERFORADO 10 according EN 771-1 Length / width / height: 245 mm / 110 mm / 100 mm <math>f_b \geq 15 \text{ N/mm}^2 / \rho \geq 2,05 \text{ kg/dm}^3</math></p>	
<p><b>Brick nº 14</b> Autoclaved aerated concrete AAC2 according to EN 771-4. Length / width / height: 599 mm / 375 mm / 249 mm <math>f_b \geq 2,0 \text{ N/mm}^2 / \rho \geq 0,35 \text{ kg/dm}^3</math></p>	<p><b>Brick nº 15</b> Autoclaved aerated concrete AAC4 according to EN 771-4. Length / width / height: 599 mm / 375 mm / 249 mm <math>f_b \geq 4,0 \text{ N/mm}^2 / \rho \geq 0,5 \text{ kg/dm}^3</math></p>		
<p><b>Brick nº 16</b> Autoclaved aerated concrete AAC6 according to EN 771-4. Length / width / height: 499 mm / 240 mm / 250 mm <math>f_b \geq 6,0 \text{ N/mm}^2 / \rho \geq 0,65 \text{ kg/dm}^3</math></p>			

## 4. PRODUCT SET UP

### 4.1. CONCRETE SET UP

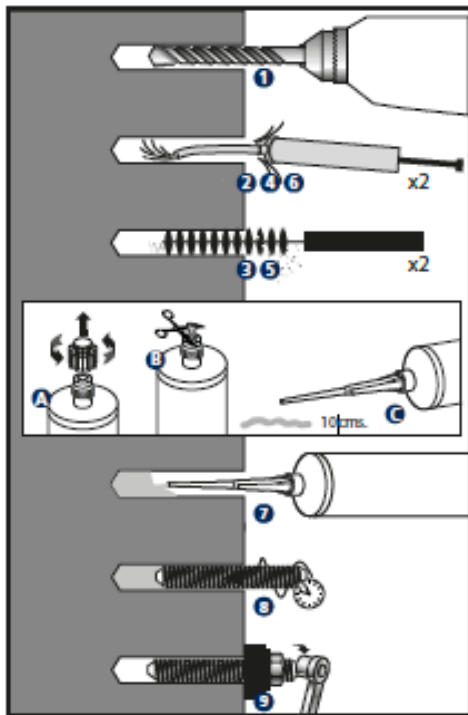

#### 1. DRILL

Check the concrete base is compact and porosity is insignificant.  
 Suitable for wet, dry or flooded drill holes.  
 Cartridge installation temperature:  $\geq 5\text{ }^{\circ}\text{C}$ .  
 Base material installation temperature: MO-PS+, MO-PSP+  $\geq -5\text{ }^{\circ}\text{C}$   
 Use drill in hammer mode.  
 Drill to the specified diameter and depth values

#### 2 - 6. BLOW AND CLEAN

Clear the drill holes completely of dust and fragments by following the procedure shown in the picture. If the drill hole is flooded, the water must be removed before mortar is injected.

#### A - B\* - C. OPEN CARTRIDGE

Screw the nozzle into the cartridge and place the assembly in the application gun. Squeeze on the trigger repeatedly until the mortar comes out of the nozzle in a uniform blue color. Any iridescence indicates improper mixing. Always discard the first two doses of each cartridge: these are never to be used for fixing. **\*For 300 ml cartridges, cut end of bag, behind seal clip.**

#### 7. INJECT MORTAR

Insert the nozzle to the bottom of the drill hole and apply mortar: gradually remove the nozzle, ensuring there are no air bubbles. Fill the hole to  $\frac{1}{2}$  and  $\frac{3}{4}$  of its depth.  
 In the event of not fully using the cartridge, leave nozzle attached. Only change if using again and handling time has expired, remembering to discard the first two doses of mortar.

#### 8. INSTALLATION

Introduce the stud to be installed by screwing it lightly down to the installation depth value manually; ensuring the mortar covers the stud thread. The introduction of the anchor must take place within the handling time. The mortar must seep from the top of the drill hole to ensure it is completely full and there are no gaps between the stud and the drill hole. While the MO-PS+ is blue, the rod can be adjusted and moved so that it is correctly fitted

### TEMPERATURE AND CURING TIME

TYPE	Base material temperature [ $^{\circ}\text{C}$ ]	Handling time [min]	Curing time [min]
MO-PS+ / MO-PSP+	-5 to 0*	28	360
	0 to +5*	18	255
	+5 to +10	10	145
	+10 to +20	6	85
	+20 to +25	5	50
	+25 to +30	4	40
	+30	4	35

\*Installation temperature not covered by the ETA.

#### 9. APPLY TORQUE

Once the curing time has elapsed (when the color is completely grey), apply torque, never exceeding the values indicated in the table.



## 4.2. MASONRY SET UP

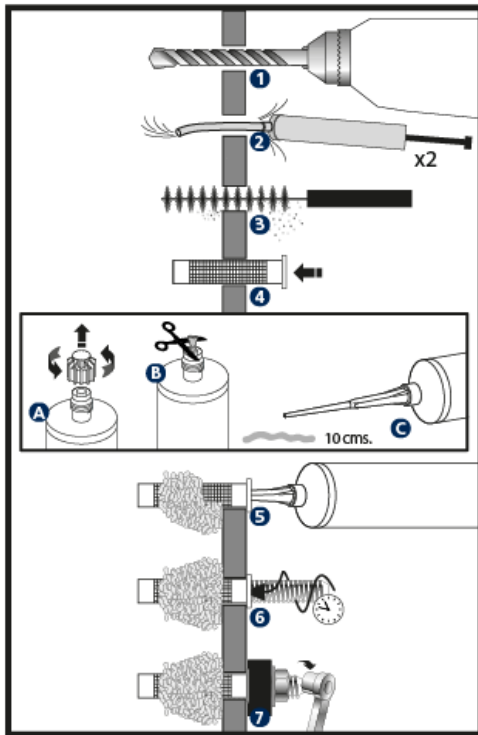

### 1. DRILL

Check the concrete base is compact and porosity is insignificant.  
 Suitable for wet, dry or flooded drill holes.  
 Cartridge installation temperature:  $\geq 5\text{ }^{\circ}\text{C}$ .  
 Base material installation temperature: MO-PS+, MO-PSP+  $\geq -5\text{ }^{\circ}\text{C}$   
 Use drill in rotation mode.  
 Drill to the specified diameter and depth values

### 2 - 3. BLOW AND CLEAN

Clear the drill holes completely of dust and fragments by following the procedure shown in the picture. If the drill hole is flooded, the water must be removed before mortar is injected.

### 4. POSITION SLEEVE(s)

Insert the metal or plastic sleeve into the drill hole so it is level with the surface of the base material.

### A – B\* – C. OPEN CARTRIDGE

Screw the nozzle into the cartridge and place the assembly in the application gun. Squeeze on the trigger repeatedly until the mortar comes out of the nozzle in a uniform blue color. Any iridescence indicates improper mixing. Always discard the first two doses of each cartridge: these are never to be used for fixing. \*For 300 ml cartridges, cut end of bag, behind seal clip.

### 5. INJECT MORTAR

Insert the nozzle to the bottom of the drill hole and apply mortar: gradually remove the nozzle, ensuring there are no air bubbles. Fill the sleeve fully.

In the event of not fully using the cartridge, leave nozzle attached. Only change if using again and handling time has expired, remembering to discard the first two doses of mortar.

### 6. INSTALLATION

Introduce the stud to be installed by screwing it lightly down to the installation depth value manually; ensuring the mortar covers the stud thread. The introduction of the anchor must take place within the handling time. The mortar must seep from the top of the sleeve hole to ensure it is completely full and there are no gaps between the stud and the drill hole. While the MO-PS+ is blue, the rod can be adjusted and moved so that it is correctly fitted

## TEMPERATURE AND CURING TIME

TYPE	Base material temperature [°C]	Handling time [min]	Curing time [min]
MO-PS+ / MO-PSP+	-5 to 0*	28	360
	0 to +5*	18	255
	+5 to +10	10	145
	+10 to +20	6	85
	+20 to +25	5	50
	+25 to +30	4	40
	+30	4	35

\*Installation temperature not covered by the ETA.

### 7. APPLY TORQUE

Once the curing time has elapsed (when the color is completely grey), apply torque, never exceeding the values indicated in the table.



## 5. STORAGE CONDITIONS

Keep the product stored in a cool, dry place, away from direct sunlight and heat sources, at an average temperature between +5 °C and +25 °C.



Shelf life of unopened cartridge: 18 months from the date of manufacture. The expiration date is indicated on the cartridge.

## 6. RESISTANCES

### 6.1 CONCRETE FIXATION

Characteristic resistances for C20/25 concrete for an isolated anchor (without considering anchor-to-anchor or anchor-to-edge distance effects) and class 5.8 studs or A4-70 stainless steel are shown in tables below.

#### CHARACTERISTIC RESISTANCES

CONCRETE CLASS	SIZE				M8	M10	M12	M16	M20	M24	
NON-CRACKED CONCRETE	ZINC PLATED	Tension	$h_{ef,min} = 8d$	$N_{Rk}$	[kN]	13,6	20,1	32,5	57,9	80,4	108,5
			Standard stud	$N_{Rk}$	[kN]	17,0	22,6	37,3	57,9	85,4	118,7
			$h_{ef,max} = 12d$	$N_{Rk}$	[kN]	20,5	30,1	48,8	86,8	120,6	162,8
		Shear	All depths 5.8	$V_{Rk}$	[kN]	<u>9,0</u>	<u>15,0</u>	<u>21,0</u>	<u>39,0</u>	<u>61,0</u>	<u>88,0</u>
			All depths 8.8	$V_{Rk}$	[kN]	<u>15,0</u>	<u>23,0</u>	<u>34,0</u>	<u>63,0</u>	<u>98,0</u>	<u>141,0</u>
		STAINLESS STEEL	Tension	$h_{ef,min} = 8d$	$N_{Rk}$	[kN]	13,6	20,1	32,5	57,9	80,4
	Standard stud			$N_{Rk}$	[kN]	17,0	22,6	37,3	57,9	85,4	118,7
	$h_{ef,max} = 12d$			$N_{Rk}$	[kN]	20,5	30,1	48,8	86,8	120,6	162,8
	Shear		All depths	$V_{Rk}$	[kN]	<u>13,0</u>	<u>20,0</u>	<u>30,0</u>	<u>55,0</u>	<u>86,0</u>	<u>124,0</u>

**DESIGN RESISTANCES**

CONCRETE CLASS	SIZE				M8	M10	M12	M16	M20	M24	
	NON-CRACKED CONCRETE	ZINC PLATED	Tension	$h_{ef,min} = 8d$	$N_{Rd}$	[kN]	7,6	11,1	18,1	32,1	44,6
Standard stud				$N_{Rd}$	[kN]	9,4	12,5	20,7	32,1	47,4	65,9
$h_{ef,max} = 12d$				$N_{Rd}$	[kN]	11,3	16,7	27,1	48,2	67,0	90,4
Shear			All depths 5.8	$V_{Rd}$	[kN]	<u>7,2</u>	<u>12,0</u>	<u>16,8</u>	<u>31,2</u>	<u>48,8</u>	<u>70,4</u>
			All depths 8.8	$V_{Rd}$	[kN]	<u>12,0</u>	<u>18,4</u>	<u>27,2</u>	<u>50,4</u>	<u>78,4</u>	<u>112,8</u>
STAINLESS STEEL		Tension	$h_{ef,min} = 8d$	$N_{Rd}$	[kN]	7,6	11,1	18,1	32,1	44,6	60,3
			Standard stud	$N_{Rd}$	[kN]	9,4	12,5	20,7	32,1	47,4	65,9
			$h_{ef,max} = 12d$	$N_{Rd}$	[kN]	11,3	16,7	27,1	48,2	67,0	90,4
		Shear	All depths	$V_{Rd}$	[kN]	<u>8,3</u>	<u>12,8</u>	<u>19,2</u>	<u>35,2</u>	<u>55,1</u>	<u>79,4</u>

**MAXIMUM LOADS RECOMMENDED (when  $\gamma_f = 1.4$ )**

CONCRETE CLASS	SIZE				M8	M10	M12	M16	M20	M24	
	NON-CRACKED CONCRETE	ZINC PLATED	Tension	$h_{ef,min} = 8d$	$N_{rec}$	[kN]	5,4	7,9	12,9	22,9	31,9
Standard stud				$N_{rec}$	[kN]	6,7	8,9	14,8	22,9	33,9	47,1
$h_{ef,max} = 12d$				$N_{rec}$	[kN]	8,1	11,9	19,3	34,4	47,8	64,6
Shear			All depths 5.8	$V_{rec}$	[kN]	<u>5,1</u>	<u>8,5</u>	<u>12,0</u>	<u>22,2</u>	<u>34,8</u>	<u>50,2</u>
			All depths 8.8	$V_{rec}$	[kN]	<u>8,5</u>	<u>13,1</u>	<u>19,4</u>	<u>36,0</u>	<u>56,0</u>	<u>80,5</u>
STAINLESS STEEL		Tension	$h_{ef,min} = 8d$	$N_{rec}$	[kN]	5,4	7,9	12,9	22,9	31,9	43,0
			Standard stud	$N_{rec}$	[kN]	6,7	8,9	14,8	22,9	33,9	47,1
			$h_{ef,max} = 12d$	$N_{rec}$	[kN]	8,1	11,9	19,3	34,4	47,8	64,6
		Shear	All depths	$V_{rec}$	[kN]	<u>5,9</u>	<u>9,1</u>	<u>13,7</u>	<u>25,1</u>	<u>39,3</u>	<u>56,7</u>

1 kN  $\approx$  100 kg

The italic font underlined values indicate steel failure; rest indicates pull-out failure.

**COEFFICIENTS FOR TENSION LOADS  
IN PULL-OUT FAILURE IN HIGH-RESISTANCE CONCRETE TYPES**

CONCRETE COEFFICIENT	C30/37	C40/50	C50/60
$\Psi_c$ (Non-cracked)	1,12	1,19	1,30

## 6.2 MASONRY FIXATION

Characteristic resistances in masonry for an isolated anchor (without considering anchor-to-anchor or anchor-to-edge distance effects) and class 5.8 studs or A4-70 stainless steel are shown in tables below.

Use categories in respect of installation and use:

- Category d/d - Installation and use in structures subject to dry, internal conditions
- Category w/d - Installation in dry or wet substrate and use in structures subject to dry, internal conditions
- Category w/w - Installation and use in structures subject to dry or wet environmental conditions

### CHARACTERISTIC RESISTANCES ( $F_{Rk}$ )

ANCHOR TYPE	THREADED ROD WITH OR WITHOUT SLEEVE, TENSION AND SHEAR [kN]												INTERNAL THREADED SOCKET WITH SLEEVE, TENSION AND SHEAR [kN]					
USE CONDITIONS	d/d				w/d				w/w				d/d, w/d			w/w		
BASE MATERIAL	M6	M8	M10	M12	M6	M8	M10	M12	M6	M8	M10	M12	M8	M10	M12	M8	M10	M12
Brick number 1	--	2,50	2,00	2,00	--	2,50	2,00	2,00	--	2,00	1,20	1,50	1,50	2,50	2,50	1,20	2,00	2,50
Brick number 2	--	0,75	1,20	0,50	--	0,75	1,20	0,50	--	0,60	0,90	0,50	--	0,75	0,40	--	0,60	0,30
Brick number 3	--	0,75	1,20	0,50	--	0,75	1,20	0,50	--	0,75	0,90	0,50	0,60	0,75	0,90	0,50	0,60	0,75
Brick number 4	--	1,50	1,50	3,00	--	1,50	1,50	3,00	--	1,50	1,50	3,00	2,00	3,00	4,00	2,00	3,00	4,00
Brick number 5	--	0,75	0,90	1,50	--	0,75	0,90	1,50	--	0,75	0,90	1,20	2,00	1,50	0,90	1,50	1,50	0,90
Brick number 6	--	1,20	1,20	0,90	--	1,20	1,20	0,90	--	0,90	0,90	0,75	0,90	1,50	0,60	0,75	1,20	0,50
Brick number 7	--	0,60	0,30	--	--	0,60	0,30	--	--	0,60	0,30	--	0,50	0,30	0,75	0,50	0,30	0,60
Brick number 8	--	0,60	1,50	1,20	--	0,60	1,50	1,20	--	0,50	1,20	0,90	--	0,40	0,60	--	0,30	0,50
Brick number 9	--	2,50	1,50	2,50	--	2,50	1,50	2,50	--	2,00	1,50	2,00	0,60	1,20	0,90	0,50	0,90	0,90
Brick number 10	--	0,75	0,50	0,75	--	0,75	0,50	0,75	--	0,75	0,50	0,60	--	--	--	--	--	--
Brick number 11	--	1,50	1,50	1,50	--	1,50	1,50	1,50	--	1,50	1,20	1,50	--	--	--	--	--	--
Brick number 12	--	0,75	--	0,60	--	0,75	--	0,60	--	0,75	--	0,50	--	--	--	--	--	--
Brick number 13	1,2	1,20	--	--	1,2	1,20	--	--	0,90	0,90	--	--	--	--	--	--	--	--
Brick number 14	0,75	0,75	0,75	0,90	0,60	0,60	0,60	0,75	0,60	0,60	0,60	0,75	--	--	--	--	--	--
Brick number 15	0,9	1,50	2,00	2,50	0,75	1,20	1,50	2,00	0,75	1,20	1,50	1,75	--	--	--	--	--	--
Brick number 16	1,2	2,50	3,00	3,50	0,90	2,00	2,50	3,00	0,90	2,00	2,00	2,50	--	--	--	--	--	--

DESIGN RESISTANCES (F <sub>Rd</sub> )																		
ANCHOR TYPE	THREADED ROD WITH OR WITHOUT SLEEVE, TENSION AND SHEAR [kN]												INTERNAL THREADED SOCKET WITH SLEEVE, TENSION AND SHEAR [kN]					
USE CONDITIONS	d/d				w/d				w/w				d/d, w/d			w/w		
BASE MATERIAL	M6	M8	M10	M12	M6	M8	M10	M12	M6	M8	M10	M12	M8	M10	M12	M8	M10	M12
Brick number 1	--	1,00	0,80	0,80	--	1,00	0,80	0,80	--	0,80	0,48	0,60	0,60	1,00	1,00	0,48	0,80	1,00
Brick number 2	--	0,30	0,48	0,20	--	0,30	0,48	0,20	--	0,24	0,36	0,20	--	0,30	0,16	--	0,24	0,12
Brick number 3	--	0,30	0,48	0,20	--	0,30	0,48	0,20	--	0,30	0,36	0,20	0,24	0,30	0,36	0,20	0,24	0,30
Brick number 4	--	0,60	0,60	1,20	--	0,60	0,60	1,20	--	0,60	0,60	1,20	0,80	1,20	1,60	0,80	1,20	1,60
Brick number 5	--	0,30	0,36	0,60	--	0,30	0,36	0,60	--	0,30	0,36	0,48	0,80	0,60	0,36	0,60	0,60	0,36
Brick number 6	--	0,48	0,48	0,36	--	0,48	0,48	0,36	--	0,36	0,36	0,30	0,36	0,60	0,24	0,30	0,48	0,20
Brick number 7	--	0,24	0,12	--	--	0,24	0,12	--	--	0,24	0,12	--	0,20	0,12	0,30	0,20	0,12	0,24
Brick number 8	--	0,24	0,60	0,48	--	0,24	0,60	0,48	--	0,20	0,48	0,36	--	0,16	0,24	--	0,12	0,20
Brick number 9	--	1,00	0,60	1,00	--	1,00	0,60	1,00	--	0,80	0,60	0,80	0,24	0,48	0,36	0,20	0,36	0,36
Brick number 10	--	0,30	0,20	0,30	--	0,30	0,20	0,30	--	0,30	0,20	0,24	--	--	--	--	--	--
Brick number 11	--	0,60	0,60	0,60	--	0,60	0,60	0,60	--	0,60	0,48	0,60	--	--	--	--	--	--
Brick number 12	--	0,30	--	0,24	--	0,30	--	0,24	--	0,30	--	0,20	--	--	--	--	--	--
Brick number 13	0,48	0,48	--	--	0,48	0,48	--	--	0,36	0,36	--	--	--	--	--	--	--	--
Brick number 14	0,38	0,38	0,38	0,45	0,30	0,30	0,30	0,38	0,30	0,30	0,30	0,38	--	--	--	--	--	--
Brick number 15	0,45	0,75	1,00	1,25	0,38	0,60	0,75	1,00	0,38	0,60	0,75	0,88	--	--	--	--	--	--
Brick number 16	0,60	1,25	1,50	1,75	0,45	1,00	1,25	1,50	0,45	1,00	1,00	1,25	--	--	--	--	--	--

MAXIMUM RECOMMENDED LOADS (F <sub>rec</sub> ) [with γ <sub>F</sub> = 1.4]																		
ANCHOR TYPE	THREADED ROD WITH OR WITHOUT SLEEVE, TENSION AND SHEAR [kN]												INTERNAL THREADED SOCKET WITH SLEEVE, TENSION AND SHEAR [kN]					
USE CONDITIONS	d/d				w/d				w/w				d/d, w/d			w/w		
BASE MATERIAL	M6	M8	M10	M12	M6	M8	M10	M12	M6	M8	M10	M12	M8	M10	M12	M8	M10	M12
Brick number 1	--	0,71	0,57	0,57	--	0,71	0,57	0,57	--	0,57	0,34	0,43	0,43	0,71	0,71	0,34	0,57	0,71
Brick number 2	--	0,21	0,34	0,14	--	0,21	0,34	0,14	--	0,17	0,26	0,14	--	0,21	0,11	--	0,17	0,09
Brick number 3	--	0,21	0,34	0,14	--	0,21	0,34	0,14	--	0,21	0,26	0,14	0,17	0,21	0,26	0,14	0,17	0,21
Brick number 4	--	0,43	0,43	0,86	--	0,43	0,43	0,86	--	0,43	0,43	0,86	0,57	0,86	1,14	0,57	0,86	1,14
Brick number 5	--	0,21	0,26	0,43	--	0,21	0,26	0,43	--	0,21	0,26	0,34	0,57	0,43	0,26	0,43	0,43	0,26
Brick number 6	--	0,34	0,34	0,26	--	0,34	0,34	0,26	--	0,26	0,26	0,21	0,26	0,43	0,17	0,21	0,34	0,14
Brick number 7	--	0,17	0,09	--	--	0,17	0,09	--	--	0,17	0,09	--	0,14	0,09	0,22	0,14	0,09	0,17
Brick number 8	--	0,17	0,43	0,34	--	0,17	0,43	0,34	--	0,14	0,34	0,26	--	0,11	0,17	--	0,09	0,14
Brick number 9	--	0,71	0,43	0,71	--	0,71	0,43	0,71	--	0,57	0,43	0,57	0,17	0,34	0,26	0,14	0,26	0,26
Brick number 10	--	0,21	0,14	0,21	--	0,21	0,14	0,21	--	0,21	0,14	0,17	--	--	--	--	--	--
Brick number 11	--	0,43	0,43	0,43	--	0,43	0,43	0,43	--	0,43	0,34	0,43	--	--	--	--	--	--
Brick number 12	--	0,21	--	0,17	--	0,21	--	0,17	--	0,21	--	0,14	--	--	--	--	--	--
Brick number 13	0,34	0,34	--	--	0,34	0,34	--	--	0,26	0,26	--	--	--	--	--	--	--	--
Brick number 14	0,27	0,27	0,27	0,32	0,21	0,21	0,21	0,27	0,21	0,21	0,21	0,27	--	--	--	--	--	--
Brick number 15	0,32	0,54	0,71	0,89	0,27	0,43	0,54	0,71	0,27	0,43	0,54	0,63	--	--	--	--	--	--
Brick number 16	0,43	0,89	1,07	1,25	0,32	0,71	0,89	1,07	0,32	0,71	0,71	0,89	--	--	--	--	--	--

### 6.3 CHEMICAL RESISTANCE

Chemical resistance of the product for different kind of chemical environments and for a specific concentration.

Chemical Environment	Concentration	Result	Chemical Environment	Concentration	Result
Aqueous Solution Acetic Acid	10%	✓	Hexane	100%	C
Acetone	100%	X	Hydrochloric Acid	10%	✓
Aqueous Solution Aluminium Chloride	Saturated	✓		15%	✓
Aqueous Solution Aluminium Nitrate	10%	✓		25%	C
Ammonia Solution	5%	X	Hydrogen Sulphide Gas	100%	✓
Jet Fuel	100%	X	Isoproyl Alcohol	100%	X
Benzene	100%	X	Linseed Oil	100%	✓
Benzoic Acid	Saturated	✓	Lubricating Oil	100%	✓
Benzyl Alcohol	100%	X	Mineral Oil	100%	✓
Sodium Hypochlorite Solution	5 - 15%	✓	Paraffin / Kerosene (Domestic)	100%	C
Butyl Alcohol	100%	C	Phenol Aqueous Solution	1%	X
Calcium Sulphate Aqueous Solution	Saturated	✓	Phosphoric Acid	50%	✓
Carbon Monoxide	Gas	✓	Potassium Hydroxide	10% / pH13	C
Carbon Tetrachloride	100%	C	Sea Water	100%	C
Chlorine Water	Saturated	X	Styrene	100%	X
Chloro Benzene	100%	X	Sulphur Dioxide Solution	10%	✓
Citric Acid Aqueous Solution	Saturated	✓	Sulphur Dioxide (40°C)	5%	✓
Cyclohexanol	100%	✓	Sulphuric Acid	10%	✓
Diesel Fuel	100%	✓		50%	✓
Diethylene Glycol	100%	✓		Turpentine	100%
Ethanol	95%	X	White Spirit	100%	✓
Ethanol Aqueous Solution	20%	C	Xylene	100%	X
Heptane	100%	C	<b>Contact only to a maximum of 25°C.</b>		C
<b>Resistant to 75°C with at least 80% of physical properties retained.</b>		✓	<b>Not Resistant</b>		X

## 7. OFFICIAL DOCUMENTATION

The following documents are available through our Sales department or on our official website: [www.indexfix.com](http://www.indexfix.com):

- MOPS Safety Data Sheet.
- European Technical Assessment ETA 13/0751 for use on non-cracked concrete according to EAD 330232-00-0601 Guide, option 7, for M8 to M24.
- European Technical Assessment ETA 17/0096 for use in masonry according to EAD 330076-00-0604 Guide.
- Classified A+ according to French Regulation DEVL11044875A relative to the emission of volatile pollutants for indoor use.
- LEED MOPS Sustainability certificate
- Declaration of Performance DoP MOPS
- INDEXcal anchor calculation software.
- INDEXmor cartridge calculation needs software.