



EV-H



EV-M



GR-Z



GI-Z



GD-Z



SJ-Z



SJ-PS



SJ-PD



SJ-O



MQ-B



MQ-BS



GS-Z



TS-GA



TS-AA



TS-GG



TS-VS

































CHARACTERISTICS

- Accessories for cable and chain
- Zinc plated
- Forged steel elements
- For securing large loads
- Applications: securing, cable fixing and protection, etc.

BASE MATERIAL



1. SELECTION CHART

ITEM	CODE	TYPE	PHOTO	MATERIAL	SURFACE TREATMENT
1	EV-H	582		Carbon steel	
2	EV-M	580		Carbon steel	
3	GR-Z	82101		Carbon steel	
4	GI-Z	----		Carbon steel	
5	GD-Z	DIN 6899A		Carbon steel	
6	SJ-Z	DIN 741		Carbon steel	
7	SJ-PS	---		Carbon steel	
8	SJ-PD	---		Carbon steel	
9	SJ-O	---		Carbon steel	
10	MQ-B	5299		Carbon steel	
11	MQ-BS	5299		Carbon steel	
12	GS-Z	---		Carbon steel	
13	TS-GA	1480		Carbon steel	
14	TS-AA	1480		Carbon steel	
15	TS-GG	1480		Carbon steel	
16	TS-VS	1480		Carbon steel	

2. INSTALLACION DATA

2.1 EV-H

Female elevation ring D-582



Surface Treatment



Zinc plated $\geq 5 \mu\text{m s/ISO 4042}$

Base Material



Cable



Chain



Rope

Installation Data

CODE	Ø CABLE	M	D1 [mm]	D2 [mm]	L1 [mm]	H1 [mm]	Axial load capacity per ring (WLL)* [kg]	Load capacity per ring (WLL)* [kg] $0^\circ < \beta \leq 45^\circ$	Load capacity per ring (WLL) * [kg]	
									$0^\circ < \beta \leq 45^\circ$	$0^\circ < \beta \leq 45^\circ$
EVH06	20	M6	20	20	36	36	75	55	38	
EVH08	20	M8	20	20	36	36	140	100	70	
EVH10	25	M10	25	25	45	45	230	170	115	
EVH12	30	M12	30	30	54	53	340	240	170	
EVH14	35	M14	35	35	63	62	490	350	245	
EVH16	35	M16	35	35	63	62	700	500	350	
EVH18	40	M18	40	40	72	71	850	600	425	
EVH20	40	M20	40	40	72	71	1200	860	600	
EVH22	45	M22	50	50	90	90	1400	1000	700	
EVH24	50	M24	50	50	90	90	1800	1290	900	
EVH27	53	M28	55	53	96	90	2100	1500	1050	
EVH30	60	M30	65	65	108	128	3200	2300	1600	
EVH36	70	M36	75	70	126	147	4600	3300	2300	
EVH42	80	M42	85	80	144	170	6300	4500	3150	
EVH48	90	M48	100	90	166	195	8600	6100	4300	



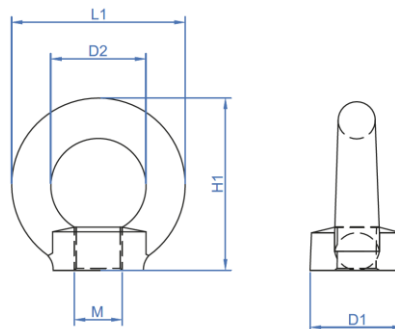

CHARACTERISTICS

- Elevation ring type 582
- Zinc plated
- Forged steel
- Female thread
- Easy installation
- Not valid for use as personal protective equipment (PPE)
- For parts whose attachment point has a female thread

DRAWING

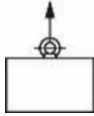
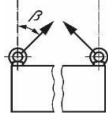
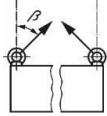
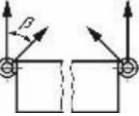

*WLL= Working Load Limit. Is the maximum safe force that a piece of lifting equipment can exert to lift, suspend, or lower, a given mass without fear of breaking.

2.2 EV-M			Male elevation ring D-580								
			Surface Treatment			Base Material					
			 Zinc plated $\geq 5 \mu\text{m s/ISO 4042}$			 Cable	 Chain	 Rope			
Installation Data											
CODE	Ø CABLE	M	D1 [mm]	D2 [mm]	L1 [mm]	H1 [mm]	H2 [mm]	Axial load capacity per ring (WLL)* [kg]	Load capacity per ring (WLL)* $0^\circ < \beta \leq 45^\circ$ [kg]	Load capacity per ring (WLL)* [kg]	
										$0^\circ < \beta \leq 45^\circ$	$0^\circ < \beta \leq 45^\circ$
											
EVM06	20	M6	20	20	36	36	13	75	55	38	
EVM08	20	M8	20	20	36	36	13	140	100	70	
EVM10	25	M10	25	25	45	45	17	230	170	115	
EVM12	30	M12	30	30	54	53	20	340	240	170	
EVM14	35	M14	35	35	63	62	27	490	350	245	
EVM16	35	M16	35	35	63	62	27	700	500	350	
EVM18	40	M18	40	40	72	71	30	850	600	425	
EVM20	40	M20	40	40	72	71	30	1200	860	600	
EVM22	45	M22	50	50	90	90	36	1400	1000	700	
EVM24	50	M24	50	50	90	90	36	1800	1290	900	
EVM27	53	M27	50	50	90	90	36	2100	1500	1050	
EVM30	60	M30	65	60	108	109	45	3200	2300	1600	
EVM33	60	M33	50	50	90	90	54	4600	3300	2300	
EVM36	70	M36	75	70	126	128	63	6300	4500	3150	
EVM42	80	M42	85	80	144	147	68	8600	6100	4300	

CHARACTERISTICS

- Elevation ring type 580
- Zinc plated
- Forged steel
- Female thread
- Easy installation
- Not valid for use as personal protective equipment (PPE)
- For parts whose attachment point has a female thread

DRAWING

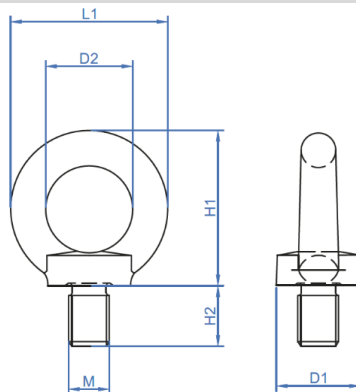

*WLL= Working Load Limit. Is the maximum safe force that a piece of lifting equipment can exert to lift, suspend, or lower, a given mass without fear of breaking.

2.3 GR-Z

Zinc plated straight shackle



Surface Treatment



Zinc plated $\geq 5 \mu\text{m s/ISO 4042}$

Base Material

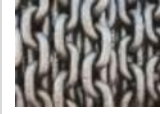

Cable

Chain

Rope

Installation Data

CODE	Ø CABLE [mm]	M	A [mm]	B [mm]	C [mm]	ØD [mm]	Ød [mm]	(WLL)* Axial load capacity per ring
GRZ05	10	M5	10	11	19	5	5	100
GRZ06	12	M6	13	11	25	6	6	160
GRZ08	16	M8	16	18	32	8	8	250
GRZ10	19	M10	19	20	38	10	10	400
GRZ11	22	M11	24	20	42	11	11	470
GRZ12	25	M12	25	26	51	12	12	600
GRZ14	28	M14	29	26	54	14	14	750
GRZ16	32	M16	32	33	64	16	16	1000
GRZ18	36	M18	37	34	64	18	18	1300
GRZ20	38	M19	38	40	75	20	20	1600
GRZ22	44	M22	44	50	88	22	22	2000
GRZ24	50	M25	51	57	100	24	24	2500
GRZ28	56	M28	57	68	115	28	28	3150
GRZ32	64	M32	64	73	127	32	32	4000
GRZ36	70	M35	75	80	153	36	36	5000
GRZ38	76	M48	75	85	152	38	38	5900
GRZ42	76	M42	86	89	155	42	42	7000
GRZ45	80	M45	90	95	180	45	45	8000
GRZ50	90	M50	102	108	200	50	50	11000

CHARACTERISTICS

- Straight shackle type 82101
- Zinc plated
- Forged steel
- Easy installation
- Securing element for use with rings and others
- For a correct use, the pin always has to be attached to the ring while the cable must pull the shackle bow
- Excellent finish
- Not valid for use as personal protective equipment (PPE)

DRAWING

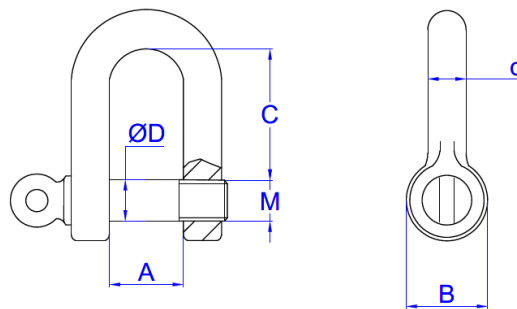

*WLL= Working Load Limit. Is the maximum safe force that a piece of lifting equipment can exert to lift, suspend, or lower, a given mass without fear of breaking.

2.4 GI-Z

Zinc plated bow shackle



Surface Treatment



Zinc plated $\geq 5 \mu\text{m s/ISO 4042}$

Base Material



Cable

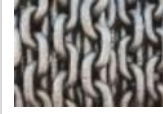

Chain



Rope

Installation Data

CODE	Ø CABLE [mm]	M	A [mm]	b [mm]	ØD [mm]	C [mm]	d [mm]	(WLL)* Axial load capacity per ring
GIZ05	8	M5	10	11	5	19	5	100
GIZ06	10	M6	13	14	6	25	6	160
GIZ08	12	M8	16	18	8	32	8	250
GIZ10	16	M10	19	20	10	38	10	400
GIZ11	19	M11	25	26	12	51	12	470
GIZ12	28	M12	32	33	16	64	16	600
GIZ14	33	M14	38	40	20	76	20	750
GIZ16	37	M16	44	50	22	89	22	1000
GIZ20	40	M20	51	57	25	100	25	1600
GIZ22	47	M22	57	68	26	115	26	2000
GIZ25	52	M25	64	73	32	127	32	2500
GIZ28	63	M28	76	85	38	152	38	3150
GIZ32	75	M32	90	96	45	180	45	4000
GIZ36	78	M36	102	108	50	200	50	5000

CHARACTERISTICS

- Bow shackle type 82016
- Zinc plated
- Forged steel
- Easy installation
- Securing element for use with rings and others
- For a correct use, the pin always has to be attached to the ring while the cable must pull the shackle bow
- Excellent finish
- Not valid for use as personal protective equipment (PPE)

DRAWING

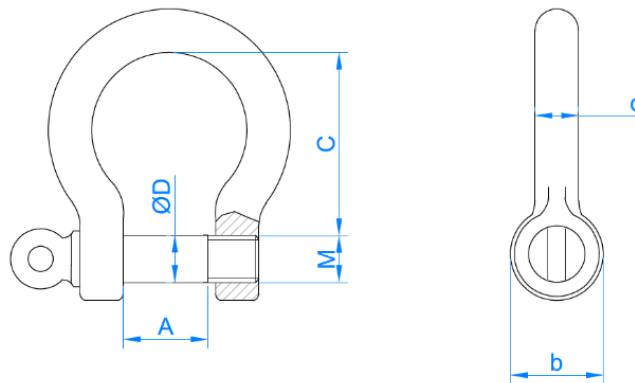

*WLL= Working Load Limit. Is the maximum safe force that a piece of lifting equipment can exert to lift, suspend, or lower, a given mass without fear of breaking.

2.5 GD-Z

Zinc plated thimble



Surface Treatment



Zinc plated $\geq 5 \mu\text{m s/ISO 4042}$

Base Material



Cable



Chain



Rope

Installation Data

CODE	Ø CABLE	A	B	L1	L2	CHARACTERISTICS
GDZ03	3,5	12	26,5	4	0,75	<ul style="list-style-type: none"> - Thimble according to DIN-6899A - Zinc plated - Easy installation - Element to ensure the protection of the cable against any friction - Excellent finish - Not valid for use as personal protective equipment (PPE)
GDZ04	4,0	13	28,5	5	0,75	
GDZ05	5,0	14	30,0	6	1,00	
GDZ06	6,0	15	33,0	7	1,00	
GDZ08	8,0	18	39,0	9	1,25	
GDZ10	10,0	22	47,5	11	1,50	
GDZ12	12,0	26	56,5	13	1,80	
GDZ13	13,0	28	61,0	14	0,80	
GDZ15	15,0	32	68,5	16	2,00	
GDZ18	18,0	40	86,5	20	2,50	
GDZ20	20,0	44	95,0	22	2,50	
GDZ24	24,0	48	103,0	26	4,00	

DRAWING

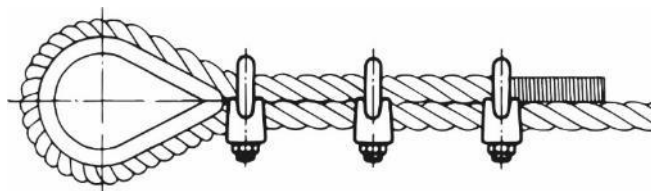
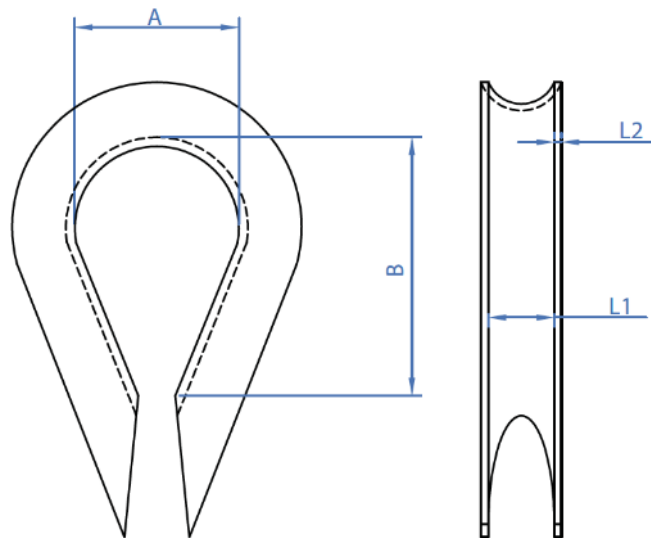

2.6 SJ-Z

Zinc plated wire road clip



Surface Treatment



Zinc plated $\geq 5 \mu\text{m s/ISO 4042}$

Base Material

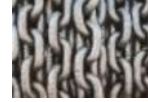

Cable

Chain

Rope

Installation Data

CODE	ØCABLE	M	A	B	D	H1	H2	L1	L2	Sw	CHARACTERISTICS
SJZ0403	3	M4	9	12	4	20	10	21	10	6,78 ÷ 7	<ul style="list-style-type: none"> - Wire rope clip according to DIN 741 - Zinc plated - Forged steel - Easy installation - Fixing element for cables in conjunction with thimble and others - For a correct use, the distance between attachments must be between 1.5 and 3 times the width L2 - Excellent finish - Not valid for use as personal protective equipment (PPE).
SJZ0505	5	M5	11	13	6	24	10	23	11	7,78 ÷ 8	
SJZ0506	6 – 6,5	M5	13	15	8	28	11	26	12	9,78 ÷ 10	
SJZ0608	8	M6	16	19	9	34	15	30	14	12,73 ÷ 13	
SJZ0810	10	M8	19	22	11	42	17	34	18	16,73 ÷ 17	
SJZ0811	11	M8	20	22	12	44	18	36	19	18,67 ÷ 19	
SJZ1013	13	M10	24	30	14	55	21	42	23	21,67 ÷ 22	
SJZ1014	14	M10	25	30	15	57	22	44	23	23,67 ÷ 24	
SJZ1216	16	M12	29	33	17	63	26	50	26		
SJZ1220	20	M12	32	38	20	75	30	54	29		
SJZ1422	22	M14	37	44	23	85	34	61	33		
SJZ1426	26	M14	41	45	27	95	37	65	35		
SJZ1630	30	M16	48	50	32	110	43	74	37		
SJZ1634	34	M16	52	55	36	120	50	80	42		
SJZ1640	40	M16	58	60	42	140	55	88	45		

DRAWING

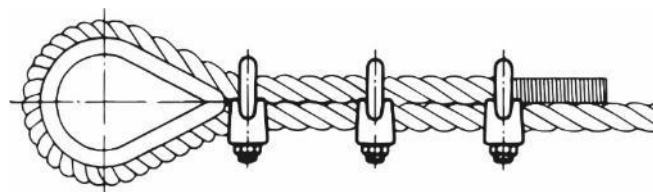
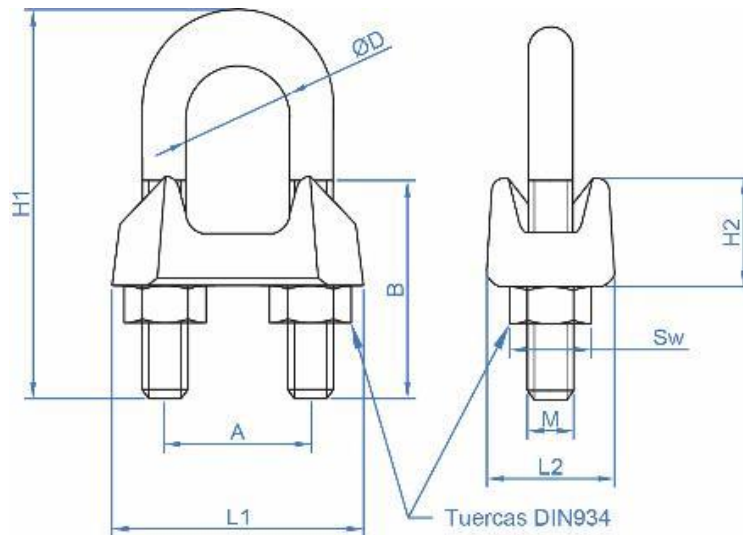

2.7 SJ-PS

Simple wire rope – Zinc plated

	Surface Treatment	Base Material		
	 Zinc plated $\geq 5 \mu\text{m s/ISO 4042}$	 Cable	 Chain	 Rope

Installation Data

CODE	ØCABLE	M	A	B	C	L	CHARACTERISTICS
SJPS0402	2	M4	13,6	12,5	5,0	15,0	<ul style="list-style-type: none"> - Zinc plated simple wire rope - Coating with excellent finish - Forged steel - Easy installation - A more aesthetic assembly is achieved by reducing the visibility of the joints - Metric nut that holds the cable against a metal plate - Not valid for use as personal protective equipment (PPE)
SJPS0403	3	M4	14,0	14,0	7,0	20,0	
SJPS0504	4	M5	16,0	17,0	7,0	22,5	
SJPS0605	5	M6	16,0	21,0	8,5	26,0	
SJPS0606	6	M6	21,0	21,0	9,0	30,0	

DRAWING

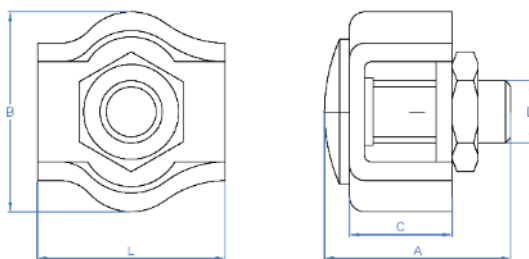

2.8 SJ-PD

Doble wire rope – Zinc plated

	Surface Treatment	Base Material		
	 Zinc plated $\geq 5 \mu\text{m s/ISO 4042}$	 Cable	 Chain	 Rope

Installation Data

CODE	ØCABLE	M	A	B	C	L	CHARACTERISTICS
SJPD0402	2	M4	14,0	13	5,0	37	<ul style="list-style-type: none"> - Zinc plated doble wire rope - Coating with excellent finish - Forged steel - Easy installation - A more aesthetic assembly is achieved by reducing the visibility of the joints - Two metric nut that holds the cable against a metal plate - Not valid for use as personal protective equipment (PPE)
SJPD0403	3	M4	14,0	14	7,0	40	
SJPD0504	4	M5	16,0	17	7,0	45	
SJPD0605	5	M5	16,0	21	8,5	52	
SJPD0606	6	M6	23,0	26	9,0	60	
SJPD0808	8	M8	25,5	31	14,0	72	

DRAWING

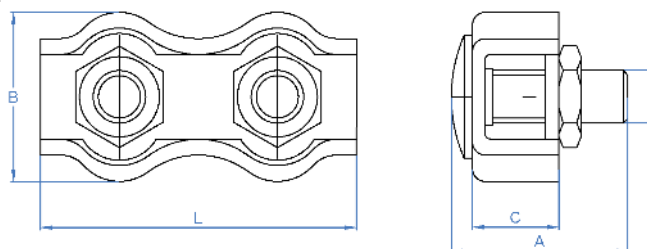

2.9 SJ-O

Oval sleeve – Zinc plated



Surface Treatment



Zinc plated $\geq 5 \mu\text{m s/ISO 4042}$

Base Material



Cable



Chain



Rope

Installation Data

CODE	ØCABLE	M	B	C	H	L	CHARACTERISTICS
SJO0502	2	M5	11	14	12	27	<ul style="list-style-type: none"> - Coating with excellent finish - Forged steel - Easy installation due to the side strips. - Specially used for esthetical applications - Philips screwdriver on the upper part of the oval that allows for optimal cable fixation - Ideal design for small cable diameters
SJO0503	3	M5	11	14	12	27	
SJO0604	4	M6	15	19	18	32	
SJO0605	5	M6	15	20	18	33	
SJO0606	6	M6	21	24	19	34	

DRAWING

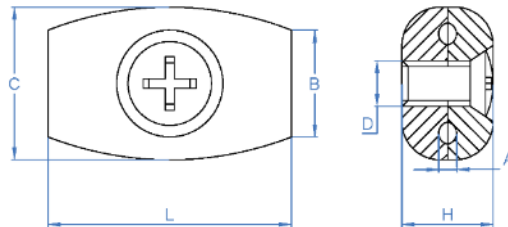

2.10 MQ-B

Snap hook – Zinc plated



Surface Treatment



Zinc plated $\geq 5 \mu\text{m s/ISO 4042}$

Base Material



Cable

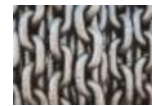

Chain



Rope

Installation Data

CODE	MEASURE	A	B	C	D	L	(WLL)* Axial load capacity per ring
MQB04	4 x 40	20	6	6,0	4,0	40	75
MQB05	5 x 50	25	8	8,0	4,8	50	100
MQB06	6 x 60	30	9	9,0	5,5	60	120
MQB07	7 x 70	35	10	10,0	6,5	70	150
MQB08	8 x 80	40	12	11,0	7,5	80	200
MQB09	9 x 90	45	15	13,0	8,5	90	300
MQB10	10 x 100	50	15	13,0	9,5	100	400
MQB11	11 x 120	57	18	16,0	10,5	120	450
MQB12	12 x 140	67	20	21,5	11,5	140	550
MQB14	14 x 180	86	25	31,0	13,5	180	630
MQB15	15 x 200	90	26	41,0	14,5	200	700

CHARACTERISTICS

- Snap hook type 5299
- Zinc plated covering
- Forged steel
- Easy installation
- Excellent finish

DRAWING

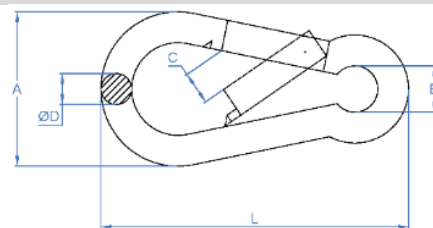

*WLL= Working Load Limit. Is the maximum safe force that a piece of lifting equipment can exert to lift, suspend, or lower, a given mass without fear of breaking.

2.11 MQ-BS

Snap hook with security nut – Zinc plated



Surface Treatment



Zinc plated $\geq 5 \mu\text{m s/ISO 4042}$

Base Material



Cable

Chain

Rope

Installation Data

CODE	MEASURE	A	B	C	D	E	L	(WLL)* Axial load capacity per ring
MQBS04	4 x 40	20	6	6,0	4,0	8	40	65
MQBS06	6 x 60	30	9	9,0	5,5	11	60	100
MQBS07	7 x 70	35	10	10,0	6,5	12	70	120
MQBS08	8 x 80	40	12	11,0	7,5	13	80	150
MQBS09	9 x 90	45	15	13,0	8,5	15	90	230
MQBS10	10 x 100	50	15	13,0	9,5	16	100	250
MQBS11	11 x 120	57	18	16,0	10,5	17	120	350
MQBS12	12 x 140	67	20	21,5	11,5	20	140	400

CHARACTERISTICS

- Snap hook with security nut type 5299
- Zinc plated covering
- Forged steel
- Easy installation
- Excellent finish

DRAWING

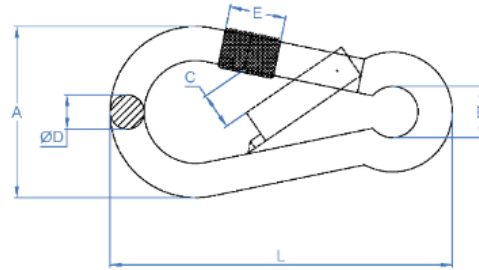

* WLL= Límite de carga de trabajo. Fuerza máxima que puede ejercer un equipo de elevación para levantar, suspender o bajar una masa determinada sin temor a romperse.

2.12 GS-Z

S hook – Zinc plated



Surface Treatment



Zinc plated $\geq 5 \mu\text{m s/ISO 4042}$

Base Material

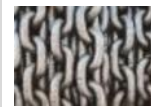
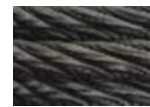

Cable

Chain

Rope

Installation Data

CODE	MEASURE	A	B	D	L	CHARACTERISTICS
GSZ0325	3 x 25	3,0	7	3	25	<ul style="list-style-type: none"> - Coating with excellent finish - Forged steel - Thanks to its design, it guarantees fast, practical and functional connections with objects intended to be hung. - High safety during the application thanks to the "S" structure - Not suitable for high loads
GSZ0435	4 x 35	4,5	11	4	35	
GSZ0545	5 x 45	6,5	14	5	45	
GSZ0655	6 x 55	7,0	16	6	55	
GSZ0765	7 x 65	8,0	20	7	65	
GSZ0875	8 x 75	10,0	23	8	75	
GSZ1010	10 x 100	11,0	25	10	105	

DRAWING

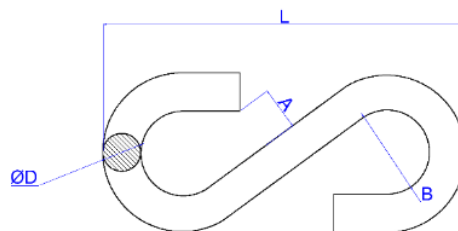

2.13 TS-GA

Turnbuckle hook/ring



Surface Treatment



Zinc plated $\geq 5 \mu\text{m s/ISO 4042}$

Base Material



Cable

Chain

Rope

Installation Data

Code	M	A [mm]	B [mm]	C [mm]	F [mm]	$\varnothing D$ [mm]	$\varnothing d$ [mm]	I [mm]	J [mm]	G [mm]	(WLL)* Axial load capacity per ring
TSGA05	M5	70	62	50	7	15,5	8,0	7,0	36,0	36,0	50
TSGA06	M6	110	98	86	9	20,5	10,0	8,0	55,0	55,0	75
TSGA08	M8	110	94	80	11	22,5	11,0	9,5	51,5	55,0	165
TSGA10	M10	130	107	88	13	31,5	14,0	12,0	67,5	68,0	235
TSGA12	M12	140	103	83	16	35,0	17,0	15,0	65,0	70,0	320
TSGA14	M14	140	114	96	20	40,5	18,0	17,0	75,0	75,0	420
TSGA16	M16	170	142	116	24	47,5	23,0	19,0	88,0	88,0	530
TSGA20	M20	200	166	132	17	52,5	25,0	20,0	105,0	105,0	730
TSGA22	M22	220	183	148	26	60,5	30,0	23,0	118,0	118,0	1120
TSGA24	M24	255	215	177	28	66,0	34,0	25,0	135,0	135,0	1550
TSGA30	M30	255	210	165	34	71,0	39,0	31,0	135,0	135,0	2240
TSGA36	M36	295	240	185	40	95,0	49,0	44,0	160,0	158,0	3530

CHARACTERISTICS

- Turnbuckle hook/ring according to DIN 1480
- Zinc plated
- Forged steel
- Easy installation
- Versatility in the installation thanks to his combination of hook and ring
- Excellent finish
- Not valid for use as personal protective equipment (PPE)

DRAWING

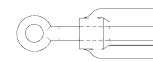
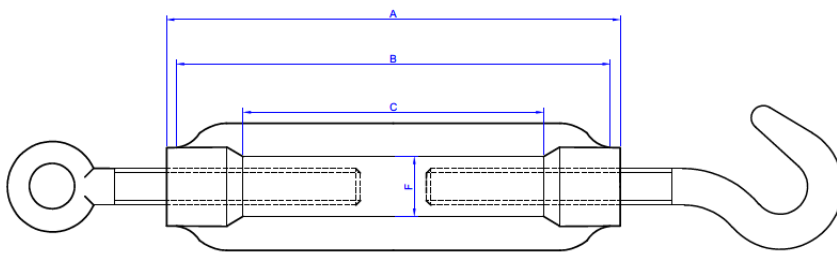

- Left threaded ring

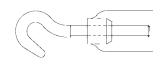

- Right threaded hook

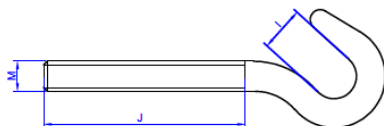

*WLL= Working Load Limit. Is the maximum safe force that a piece of lifting equipment can exert to lift, suspend, or lower, a given mass without fear of breaking.

2.14 TS-AA

Turnbuckle ring/ring

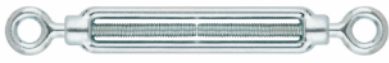

Surface Treatment



Zinc plated $\geq 5 \mu\text{m s/ISO 4042}$

Base Material



Cable

Chain

Rope

Installation Data

CODE	M	A [mm]	B [mm]	C [mm]	F [mm]	$\varnothing D$ [mm]	$\varnothing d$ [mm]	G [mm]	H [mm]	(WLL)* Axial load capacity per ring
TSAA005	M5	70	62	50	7	15,5	8,0	36	58,5	140
TSAA006	M6	110	98	86	9	20,5	10,0	55	81,5	235
TSAA008	M8	110	94	80	11	22,5	11,0	55	86,5	320
TSAA010	M10	130	107	88	13	31,5	14,0	68	106,5	535
TSAA012	M12	140	103	83	16	35,0	17,0	70	113,0	665
TSAA014	M14	140	114	97	20	40,5	18,0	75	125,5	1335
TSAA016	M16	170	142	116	24	47,5	23,0	88	148,0	1665
TSAA020	M20	200	166	132	17	52,5	25,0	105	170,0	2535
TSAA022	M22	220	183	148	26	60,5	30,0	118	192,0	2665
TSAA024	M24	255	215	177	28	66,0	34,0	135	214,0	3665
TSAA030	M30	255	210	165	34	71,0	39,0	135	226,0	5335
TSAA036	M36	295	240	185	40	95,0	49,0	158	279,5	8665

CHARACTERISTICS

- Turnbuckle ring/ring in accordance to DIN 1480
- Zinc plated coating
- Forged steel
- Easy installation
- Optimal assembly for applications that require a high level of security and greater tensile strength, this is guaranteed by placing rings on both sides of the tensioner.
- Excellent finish
- Not valid for use as personal protective equipment (PPE)

DRAWING

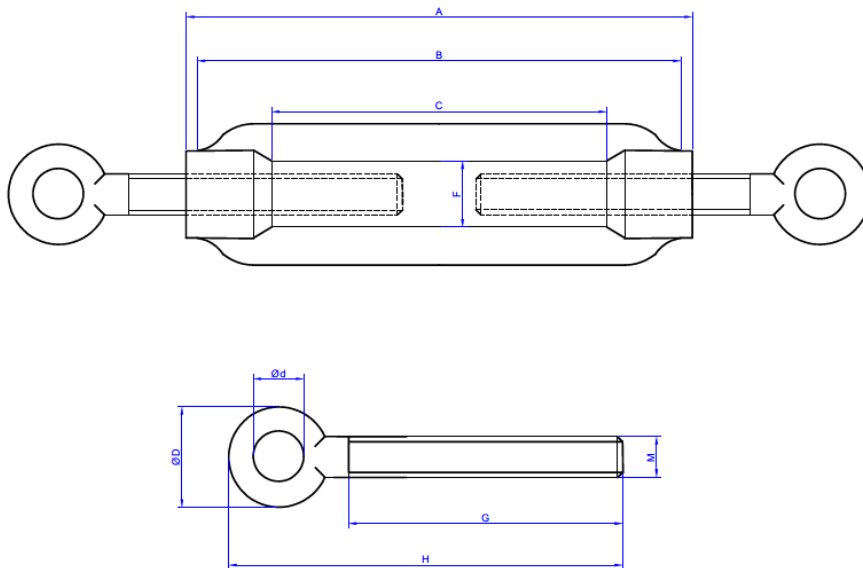

*WLL= Working Load Limit. Is the maximum safe force that a piece of lifting equipment can exert to lift, suspend, or lower, a given mass without fear of breaking.

2.15 TS-GG

Turnbuckle hook/hook



Surface Treatment



Zinc plated $\geq 5 \mu\text{m s/ISO 4042}$

Base Material



Cable



Chain



Rope

Installation Data

CODE	M	A [mm]	B [mm]	C [mm]	F [mm]	I [mm]	G [mm]	H [mm]	(WLL)* Axial load capacity per ring
TSGA05	M5	70	62	50	7	7,0	36,0	63,5	50
TSGA06	M6	110	98	86	9	8,0	55,0	86,0	75
TSGA08	M8	110	94	80	11	9,5	51,5	96,0	165
TSGA10	M10	130	107	89	13	12,0	67,5	119,5	235
TSGA12	M12	140	103	83	16	15,0	65,0	130,5	320
TSGA14	M14	140	114	97	20	17,0	75,0	139,0	420
TSGA16	M16	170	142	116	24	19,0	88,0	161,0	530
TSGA20	M20	200	166	132	17	20,0	105,0	192,0	730
TSGA22	M22	220	183	148	26	23,0	118,0	227,0	1120
TSGA24	M24	255	215	177	28	25,0	135,0	250,0	1550
TSGA30	M30	255	210	165	34	31,0	135,0	278,0	2240
TSGA36	M36	295	240	185	40	44,0	160,0	315,0	3530

CHARACTERISTICS

- Turnbuckle ring/ring in accordance to DIN 1480
- Zinc plated coating
- Forged steel
- The double hook allows a fast and easy installation
- Especially for applications where it is necessary to tighten ropes with loops, rig cables, bars, chains, etc. (Faster installation)
- Excellent finish
- Not valid for use as personal protective equipment (PPE)

DRAWING

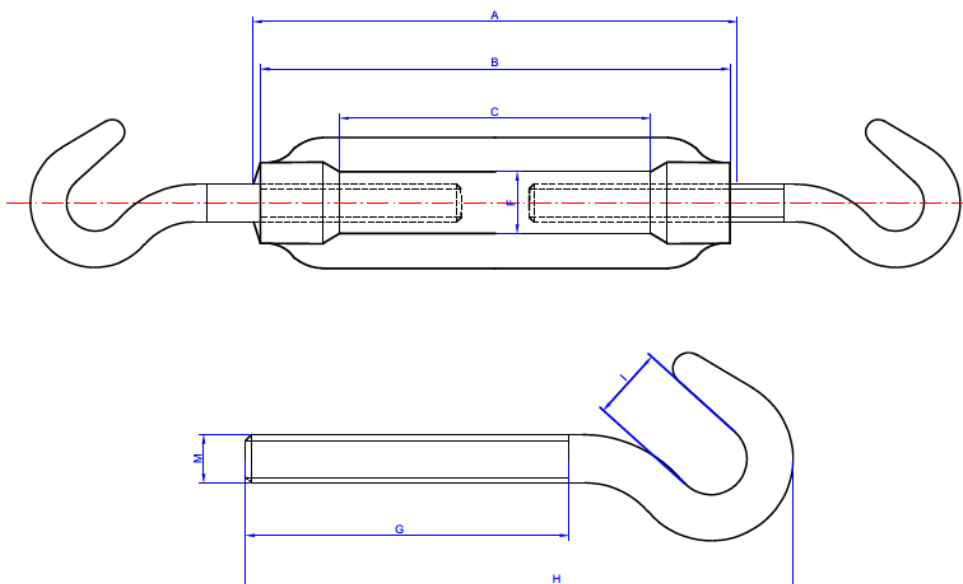

*WLL= Working Load Limit. Is the maximum safe force that a piece of lifting equipment can exert to lift, suspend, or lower, a given mass without fear of breaking.

2.16 TS-VS

Welding rod turnbuckle



Surface Treatment



Zinc plated $\geq 5 \mu\text{m s/ISO 4042}$

Base Material



Cable

Chain

Rope

Installation Data

CODE	M	A [mm]	B [mm]	C [mm]	F [mm]	J [mm]	G [mm]	H [mm]
TSVS06	M6	110	98	86	9	5,35	65	120
TSVS08	M8	110	94	80	11	7,00	65	120
TSVS10	M10	130	107	89	13	8,80	75	150
TSVS12	M12	140	103	83	16	10,80	75	150
TSVS14	M14	140	114	97	20	12,70	85	175
TSVS16	M16	170	142	116	24	14,50	100	200
TSVS20	M20	200	166	132	17	18,20	120	220
TSVS22	M22	220	183	148	26	21,70	145	240
TSVS24	M24	255	215	177	28	22,50	150	260
TSVS30	M30	255	210	165	34	27,50	160	260
TSVS36	M36	295	240	185	40	33,10	180	300

CHARACTERISTICS

- Welding rod turnbuckle in accordance to DIN 1480
- Zinc plated coating
- Forged steel
- Easy installation
- Specially designed for applications where welding is required to join cables.
- It is essential to carry out a precise weld to guarantee the correct functioning of the assembly.
- Excellent finish
- Not valid for use as personal protective equipment (PPE)

DRAWING

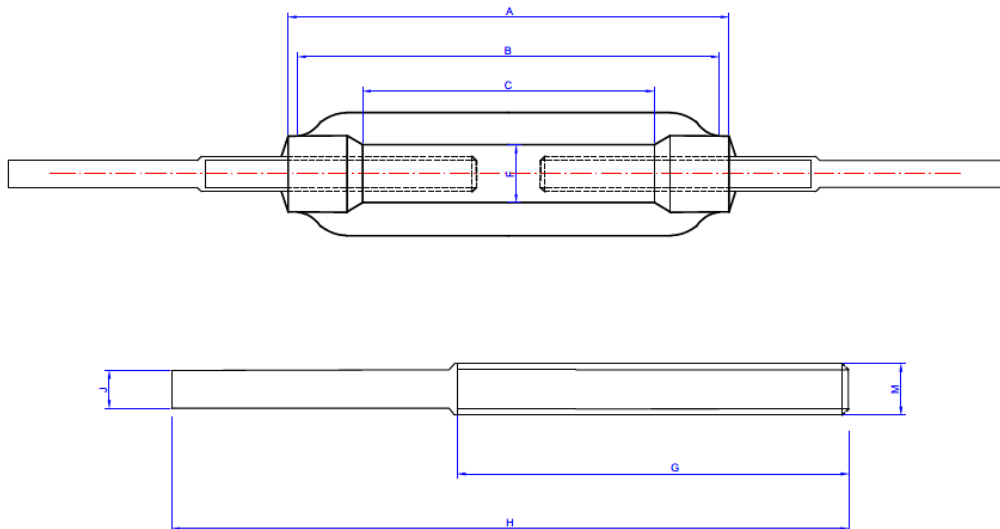

4. INSTALLATION PROCESS AND RECOMMENDATIONS

4.1 EV-H / EV-M

Female/male elevation ring

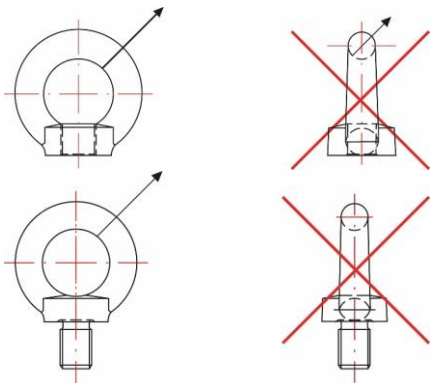

- Before use it, the ring must be checked for its correct seating and apparent damage.
- Do not continue with the use of deformed rings or reuse them, if possible, these should be replaced.
- In case of installing the elevation ring in a through hole, one nut must be fully threaded and tightened from the other side.
- The allowable load values shown in the second column apply to a maximum angle of 45°, and the maximum values shown in the third column apply to a maximum angle of 45° in all directions regarding the plane of the ring. The rings must not be loaded laterally (see attached images). In those cases where a specific position has been specified to thread the ring, use appropriate washers to avoid not allowable loads.

4.2 GR-Z

Straight shackle

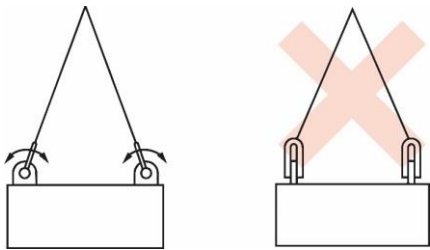

Figure 1

1. Installation:

- Shackles should be inspected before its use to ensure that:
 - a) The body and the pin of the shackle are of the same size, type and manufacture.
 - b) All marks are legible.
 - c) The body and pin threads are not damaged.
 - d) The body and the pin are not twisted.
 - e) The body and the pin are not unduly worn.
 - f) El cuerpo y el pasador estén exentos de entallas, muescas, grietas y corrosión.
 - g) The body and the pin are free of notches, nicks, cracks and corrosion.
- Make sure, if applicable, that the pin is correctly screwed into the shackle head, that is, tighten by hand and then with a punch or another appropriate tool, until the flattened part of the pin seats on the head of the shackle. Make sure that the pin is long enough so that it can be fully inserted in the threaded head, or the flattened part of the pin reaches the other head.
- In all cases, when the pin is correctly attached to the shackle body, the width between the two legs, W, should not be significantly reduced.
- An incorrect pin positioning may be due to a bent pin, a lower pitch threading, or a misalignment between the holes. In these cases, the shackle is never used.

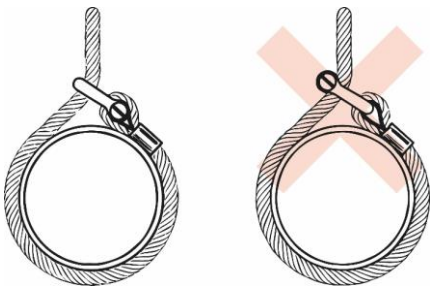

Figure 2

2. Use

- The correct type of shackle for each application is selected from the provided information.
- Shackles should not be used in a way that creates lateral loads. This means that the body of the shackle should be loaded along the axis of its centre line (see Figure 1).
- When using multi-leg sling shackles, the effect of the angle between the legs of the sling should be considered. The more the angle opens, the more the load increases in each leg of the sling and therefore on the shackles.
- When a shackle is used to attach two slings to the hook of a lifting device, the two slings should be attached to the body of a bow shackle, and the hook should be placed on the pin of the shackle. The angles between the slings must not exceed 120°.
- To avoid loading the shackle with an eccentric load, spacers can be placed on one or both ends of the shackle pin (see Figure 2).

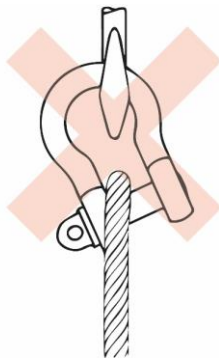
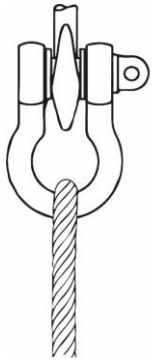

Figure 3

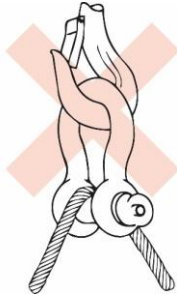
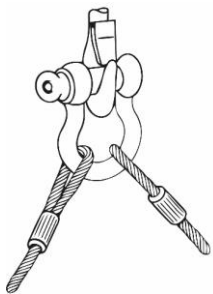

Figure 4

- The width between the shackle jaws should not be reduced by welding washers or spacers to the inside faces of the heads, or by closing the jaws, because this will have a detrimental effect on the properties of the shackle.
- When a shackle is used to secure the upper part of a set of cable groups, the load on that shackle is increased by the block and tackle effect.
- Avoid applications in which due to movement (for example, the load or the cable ones) the shackle pin can rotate and eventually unscrew (see Figures 3 and 4).
- In applications where the pin must be left in place for extended periods of time, or when maximum security is required, a type X pin should be used.
- Avoid applications where the load is unstable (see Figure 4).
- Shackles should not be modified, heat treated, galvanized or coated without the approval of the manufacturer.
- Do not use shackles outside the temperature range -20 ° C to 200 ° C without consulting the manufacturer.
- Shackles should not be immersed in acidic solutions or exposed to acid fumes or other chemicals without the approval of the manufacturer. Attention must be paid to the fact that certain manufacturing processes involve acid solutions, vapours, etc. and in these cases, advice should be asked to the manufacturer.
- The choice of shackles assumes the absence of exceptionally dangerous conditions. Exceptionally hazardous conditions include offshore activities, lifting people, and lifting potentially dangerous loads such as molten metals, corrosive materials or fissile materials. In these cases, a competent person should assess the level of risk and the safe lifting load should be reduced in accordance with the maximum working load.