



ABE – DIN-7504-K



AUTO



ABEI – DIN 7504-K A2



TDR



ARE – DIN-7504-K RE



ATAPO

CHARACTERISTICS

- Drill point: drill material directly – no need for pre-drilled hole.
- Self-tapping thread.
- Wide variety of diameters and lengths for different applications: flexibility in installation.
- Zinc plated coatings, available in different coatings upon request.
- Versions in standard commercial lacquered plate colours (RAL colour scheme).
- Coloured caps available for hexagonal heads.

APPLICATIONS







- For joining metallic or plastic elements together as well as joining other materials on metallic materials.
- Versions with galvanized steel-EPDM or stainless steel-EPDM washer for sealed joints in façades and roofing, in different diameters.

BASE MATERIALS



APPLICATION EXAMPLES



1. RANGE							
ITEM	DENOMINACION	PHOTO	REGULATION	HEAD	ØEPDM WASHER (1)	MATERIAL / COATING (2) (3)	MATERIAL TO BE FIXED
1	ABE DIN-7504-K		DIN 7504K	Hexagonal with washer	14, 16, 18, 25	Steel / Zinc-plated	Steel
2	ABEI DIN-7504-K-A2		DIN 7504K	Hexagonal with washer	---	Stainless Steel	Aluminium
3	ARE DIN-7504-K RE		---	Hexagonal with washer	16, 18, 25	Steel / Zinc-plated	Steel
4	AUTO		---	Hexagonal with washer	16	Steel / Zinc-plated	Steel
5	TDR		---	Hexagonal with washer	25	Steel / Zinc-plated	Steel
6	ATAPO		---	Hexagonal	---	---	---

(1) EPMD washer characteristics according to ARVUL Data Sheet.
 (2) Coatings: Zinc-plated $\geq 5 \mu\text{m}$ according to ISO 4042 A2J
 Black zinc-plated $\geq 5 \mu\text{m}$ according to ISO 4042 A2N
 (3) Available in various coatings and colours upon request.

MATERIALS

Characteristic	ABE - ARE - AUTO	ABEI
Material	Special steel for SAE J403 1022 thermal treatment	A2 - Stainless Steel
Surface hardness	> 560 HV	--
Core hardness	270 - 425 HV	--
Depth hardness	ST 2.5 – 3.5: 0.05 – 0.18 mm. ST 3.9 – 5.5: 0.10 – 0.23 mm. ST 6.3: 0.15 – 0.28 mm.	--

* Values as per DIN7504.

POINT SELECTION

The choice of screw point must be such that the total thickness of materials to be joined (including any intermediate spaces) is lower than the edge of the drill point; otherwise screw breakage may occur during installation.

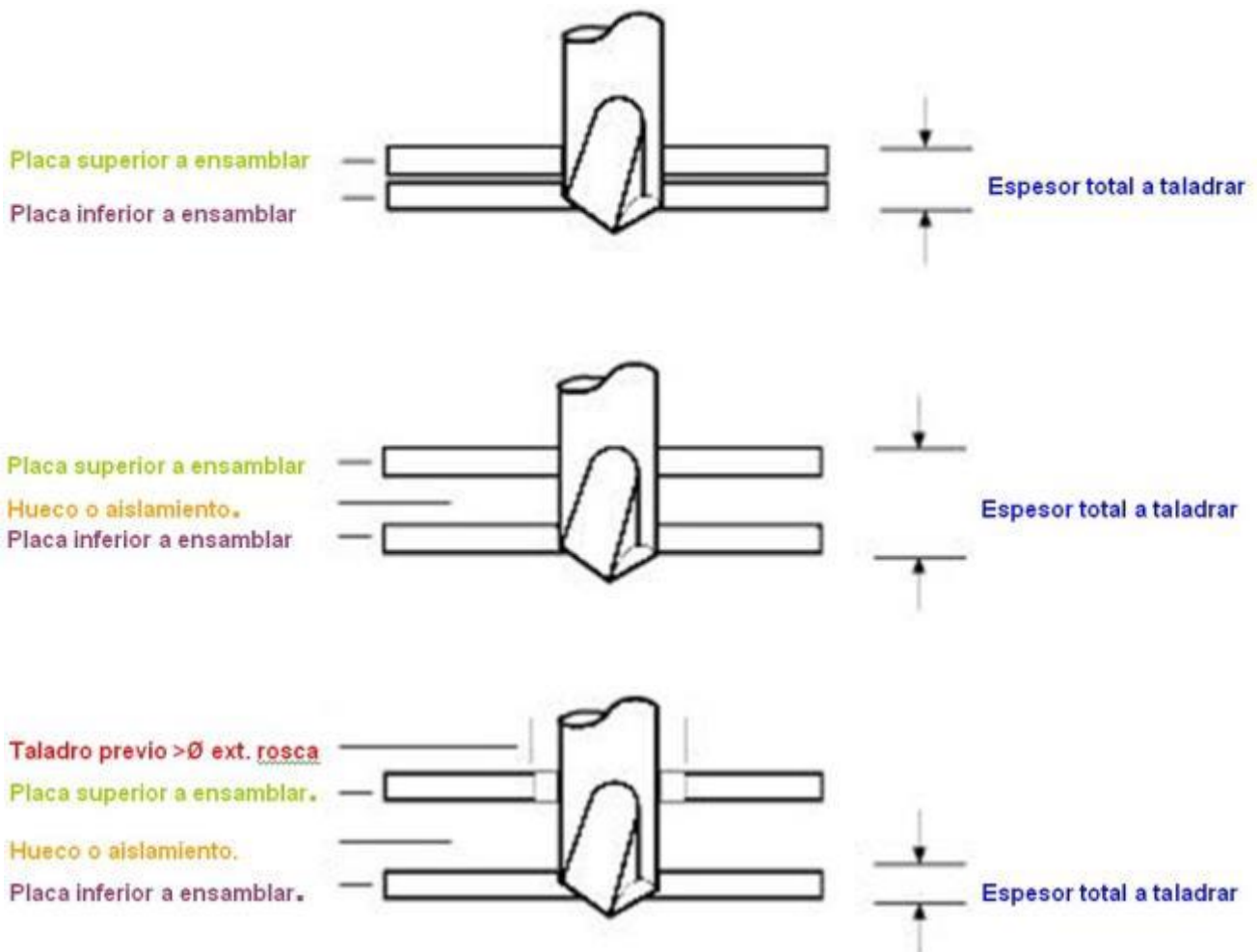

INSTALLATION PARAMETERS

Parameter			ST 3.5	ST 3.9	ST 4.2	ST 4.8	ST 5.5 M 5.5	ST 6.3
Drill Speed	Steel	[rpm]	1800 - 2500				1000 - 1800	
	Stainless Steel	[rpm]	1000 - 1500				600 - 1000	

*At high drilling times or excessive drilling speed there is a risk of burning the drill tip, thus not being able to drill the material.

SCREW	ØTHREAD	THICKNESS TO BE FIXED IN STEEL [mm]	
AUTO	5.5	4.0	12.0

ABE ABEI	6.3		2,5		6,0	
	5.5		1,75		5,25	
	4.8		1,75		4,4	
	4.2		1,75	3,0		
	3.9		0,7	2,4		
	3.5		0,7	2,25		

ARE	6.3		1.0	1.5	
	5.5		1.0	1.5	
	4.8	0.3	1.0		

0,00 0,25 0,50 0,75 1,00 1,25 1,50 1,75 2,00 2,25 2,50 2,75 3,00 3,25 3,50 3,75 4,00 4,25 4,50 4,75 5,00 5,25 5,50 5,75 6,00 6,5 7,0 7,5 8,0 8,5 9,0 9,5 10,0 10,5 11,0 11,5 12,0

MAXIMUM THICKNESS TO BE FIXED

Length	ST 3,5	ST 3,9	ST 4,2	ST 4,8	ST 5,5	ST 6,3
9,5	2,85					
11	4,2					
13	6,2	5,8	4,3	3,7		
16	9,2	8,8	7,3	5,5		
19	12,1	11,7	10,3	8,7	8,7	7
22	15,1	14,7	13,3	11,7	11,7	10
25	18,1	17,7	16,3	14,7	14,7	13
32	25,1	24,5	23	21,5	21,5	20
38		30,5	29	27,5	27,5	26
45			36	34,5	34,5	33
50			41	39,5	39,5	38
60				49,5	49,5	48
63				52,5	52,5	51
73				62,5	62,5	61
75				64,5	64,5	63
80				69,5		68
90				79,5		78
100				89,5		88
110						98
120						108
130						118
140						128
150						138
160						148
180						168
200						188
220						208
240						228

SCREW RESISTANCE CHARACTERISTICS*

Values for carbon steel screws

SIZE	TENSION [kN]	SHEAR [kN]
ST 2.9	2.62	1.31
ST 3.5	3.81	1.91
ST 3.9	4.64	2.32
ST 4.2	5.26	2.63
ST 4.8	7.11	3.56
ST 5.5	9.63	4.82
ST 6.3	13.36	6.68

Values for stainless steel screws

SIZE	TENSION [kN]	SHEAR [kN]
ST 4.2	3.50	1.75
ST 4.8	5.65	2.82
ST 5.5	9.34	4.67

1 kN ≈ 100 Kg

For tension loads, the inherent resistance of plates to be fixed must be taken into account, which is usually less than the resistance of the screw itself, as the screw will probably tear the plates.

RECOMMENDED TENSION LOAD IN STEEL PLATE

SIZE	RECOMMENDED LOAD					
	e[mm]	N[kN]	e[mm]	N[kN]	e[mm]	N[kN]
ST 3.5	0.8	0.55	1.5	0.89	2.0	1.13
ST 3.9	0.8	0.54	1.5	0.97	2.0	1.50
ST 4.2	2.0	1.63	2.5	1.51	3.0	2.62
ST 4.8	2.0	1.87	3.0	2.77	4.0	3.71
ST 5.5	2.0	1.77	3.5	2.86	5.0	3.43
ST 6.3	2.5	1.44	4.0	3.19	5.0	4.83

RECOMMENDED TENSION LOAD IN ALUMINIUM PLATE

SIZE	RECOMMENDED LOAD					
	e[mm]	N[kN]	e[mm]	N[kN]	e[mm]	N[kN]
ST 4.8	2.0	0.95	3.0	1.52	4.0	2.10
ST 5.5	2.0	0.66	4.0	2.48	5.0	3.44
ST 6.3	2.0	0.78	4.0	2.47	6.0	4.51

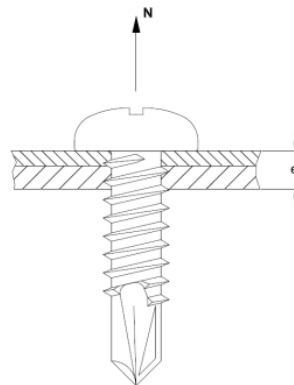

2. INSTALLATION DATA

2.1 – ABE – DIN 7504-K

Self-drilling screw - hexagonal head with embossed washer



Properties



Steel



Zinc-plated coating



Available in different colours

Base material

Properties



Plate assembly



Plate profile



Hexagonal with embossed washer



Hexagonal with embossed washer



Screw point

Installation data

CODE		ST 3.5	ST 4.2	ST 4.8	ST 5.5	ST 6.3
d _k : washer head diameter	[mm]	8	8.5	10	10.5	12.6
k: head thickness	[mm]	3.3	4.1	4.3	4.3	6.3
s: spanner	[mm]	5,5	7	8	8	10
D: exterior thread diameter	[mm]	3.53	4.22	4.80	5.46	6.25
p: thread	[mm]	1.3	1.4	1.6	1.8	1.8
l: lengths	[mm]	9.5 - 32	13 - 38	13 - 38	19- 75	19 - 240
Installation bit code (hexagonal magnetic bit)		BOCA055	BOCA007	BOCA008	BOCA008	BOCA010
Drill capacity	[mm]	0.70 - 2.25	1.75 - 3.00	1.75 - 4.40	1.75 - 5.25	2.50 - 6.00

DRAWING

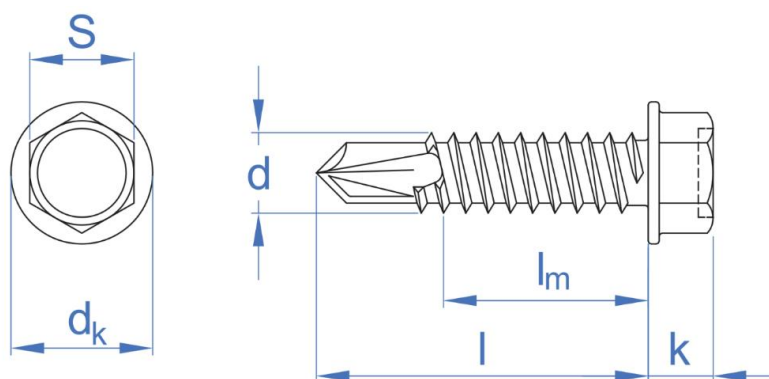

- Zinc-plated finish.
- For general plate-plate joints.
- Versions with assembled EPMD washer for sealed joints in façades and roofing (consult ARVUL Technical Data Sheet).



2.2 – ABEI - DIN-7504-K A2

Self-drilling screw - hexagonal head with embossed washer Stainless Steel A2

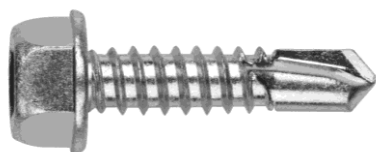

Properties

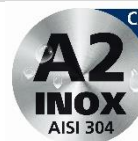

Stainless Steel A2

Base material

Properties



Plate assembly

Plate profile

Aluminium

Hexagonal with embossed washer

Hexagonal with embossed washer

Reduced screw point

Installation data

CODE		ST 4.2	ST 4.8	ST 5.5	ST 6.3
d _k : washer head diameter	[mm]	8.5	10	10.5	12.6
k: head thickness	[mm]	4.1	4.3	4.3	6.3
s: spanner	[mm]	7	8	8	10
D: exterior thread diameter	[mm]	4.22	4.80	5.46	6.25
p: thread	[mm]	1.4	1.6	1.8	1.8
l: lengths	[mm]	13 - 38	13 - 38	19- 75	19 - 140
Installation bit code (hexagonal magnetic bit)		BOCA007	BOCA008	BOCA008	BOCA010
Drill capacity	[mm]	1.75 - 3.00	1.75 - 4.40	1.75 - 5.25	2.50 - 6.00



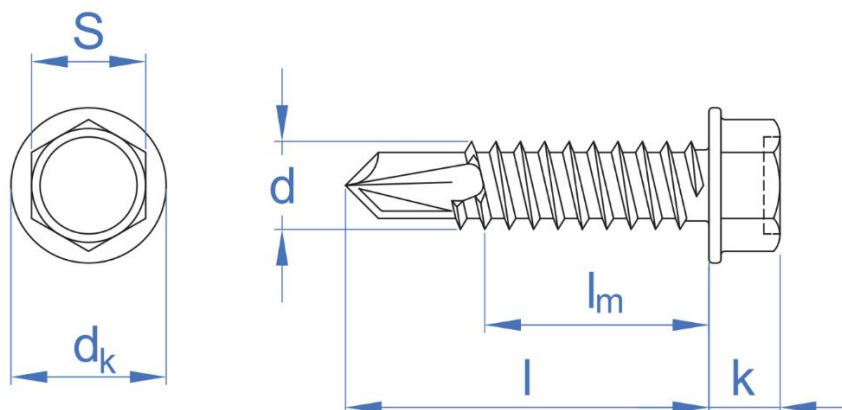

DRAWING









- Stainless Steel A2.
- For general plate-plate joints made of aluminium.

2.3 – ARE – DIN-7504-K RE

Self-drilling screw with reduced point and 8mm hexagonal head

	Properties		
	 <p>Steel</p>	 <p>Zinc-plated coating</p>	 <p>Available in different colours</p>

Base material			Properties		
 <p>Plate assembly</p>	 <p>Plate profile</p>	 <p>Aluminium</p>	 <p>Hexagonal with embossed washer</p>	 <p>Hexagonal with embossed washer</p>	 <p>Reduced screw point</p>

		Installation data		
CODE		ST 4.8	ST 5.5	ST 6.3
d _k : washer head diameter	[mm]	11	11	11
k: head thickness	[mm]	4.45	5.45	5.45
s: spanner	[mm]	8	8	8
D: exterior thread diameter	[mm]	4.80	5.46	6.25
p: thread	[mm]	1.6	1.8	1.8
l: lengths	[mm]	16 - 19	22	20 - 80
Installation bit code (hexagonal magnetic bit)		BOCA008	BOCA008	BOCA008
Maximum drill capacity	[mm]	0.0 - 1.0	1.0 - 1.5	1.0 - 1.5

DRAWING

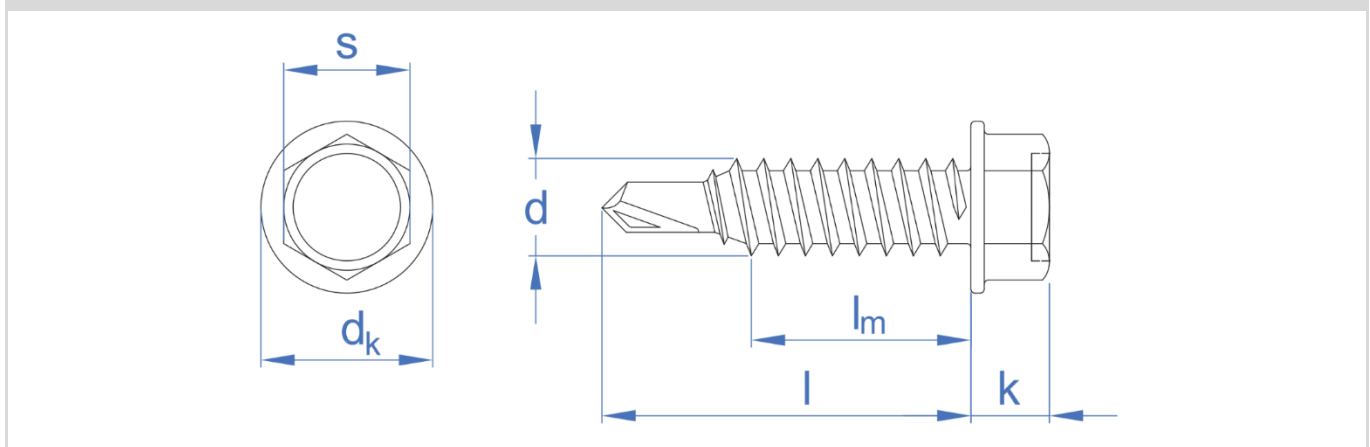

- Zinc-plated finish.
- Low thickness plate-plate joints, up to 1.5 mm. The point performs a prior drill-hole with a smaller diameter. The thread, with a greater diameter, creates an extrusion in the plate, lengthening and strengthening the threaded area.
- Drill following the upper part of the rpm range from the table in section 5.
- Versions with assembled EPDM washer for sealed joints in façades and roofing (consult ARVUL Technical Data Sheet).



2.4 - AUTO

Self-drilling screw for girders - screw point no.5
- hexagonal head



Properties



Steel



Zinc-plated coating



Available in different colours

Base material

Properties



Plate assembly



Plate profile

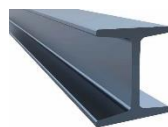

IPN



Hexagonal with embossed washer



Hexagonal with embossed washer



Girder screw point

Installation data

CODE		M 5.5
d _k : washer head diameter	[mm]	11
k: head thickness	[mm]	5.3
s: spanner	[mm]	8
Point		#5
D: exterior thread diameter	[mm]	5.5
p: thread	[mm]	1.06
l: lengths	[mm]	32 - 38
Installation bit code (hexagonal magnetic bit)		BOCA008
Drill capacity	[mm]	4.0 – 12.0

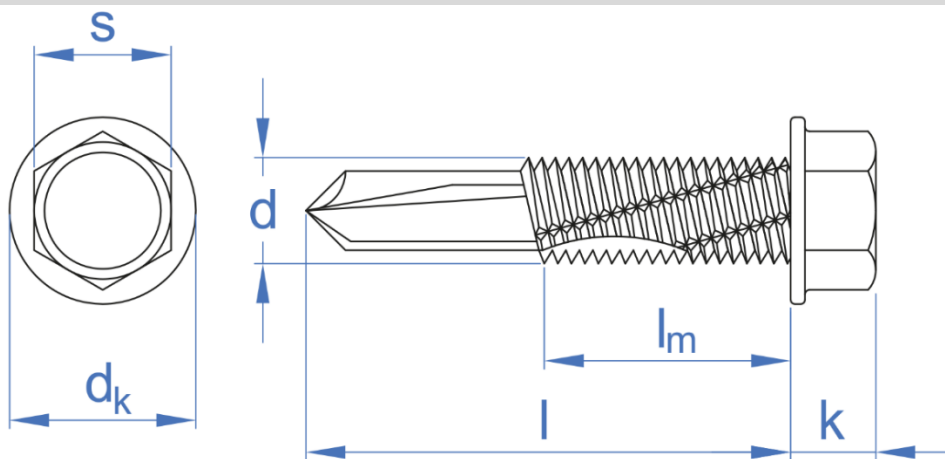

DRAWING







- Zinc-plated finish.
- For general plate-plate joints for thicknesses up to 12 mm.
- Versions with assembled EPDM washer for sealed joints in façades and roofing (consult ARVUL Technical Data Sheet).

2.5 - TDR

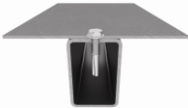
Repair screw for AUE/ABE with EPDM washer

	Properties	
	 Steel	 Zinc-plated coating

Base material		Properties		
				
Plate assembly	Plate profile	Hexagonal with embossed washer	Hexagonal with embossed washer	Self-tapping Point C

Installation data		M 5.5
CODE		
d _k : washer head diameter	[mm]	13
k: head thickness	[mm]	6.35
s: spanner	[mm]	10
ØA: EPDM washer diameter	[mm]	25
D: exterior thread diameter	[mm]	7.0
p: thread	[mm]	2.0
l: lengths	[mm]	25 - 32 - 38
Installation bit code (hexagonal magnetic bit)		BOCA012

DRAWING

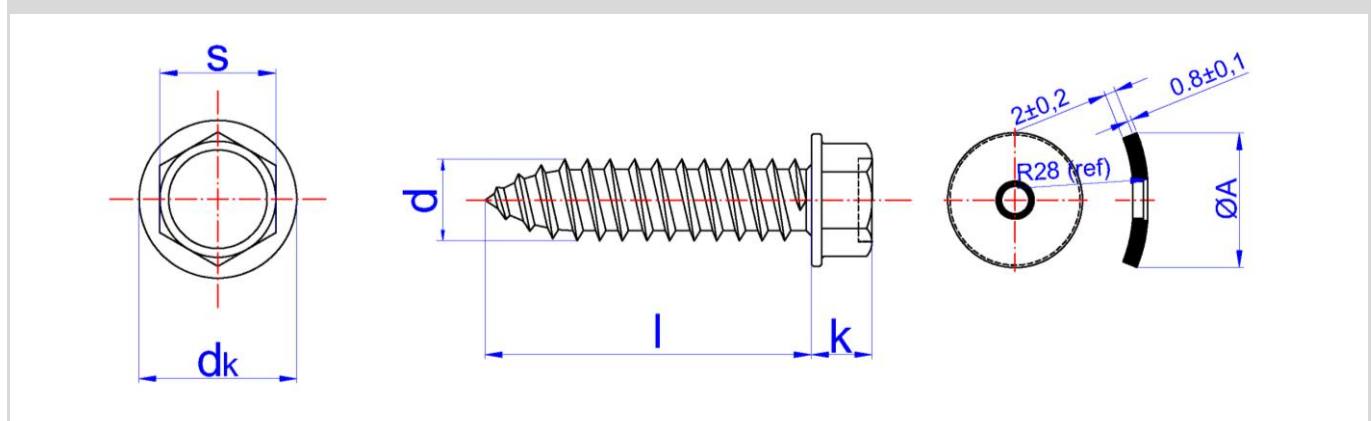

2.6 - ATAPO

COLOURED CUPS FOR HEAD SCREWS

- **ATAPO:** Plastic cups for 8- and 10-mm. hexagonal heads:

Code		RAL	Colour
ATAPO08AR	ATAPO10AR	RAL 1.001	Sand
ATAPO08RC	ATAPO10RC	RAL 3.003	Coral red
ATAPO08RT	ATAPO10RT	RAL 3.011	Tile red
ATAPO08VN	ATAPO10VN	RAL 6.028	Navarre green
ATAPO08BP	ATAPO10BP	RAL 9.010	Pyrenees white
ATAPO08NE	ATAPO10NE	RAL 9.005	Black intense
ATAPO08BO	ATAPO10BO	RAL 9.002	Oyster white
ATAPO08BS	ATAPO10BS	RAL 9.003	Signal White
ATAPO08GM	ATAPO10GM	RAL 9.006	White Aluminum
ATAPO08RX	ATAPO10RX	RAL 3.009	Oxide Red
ATAPO08PC	ATAPO10PC	RAL 8.004	Copper Brown



- **Application:**
Ornamental finish, avoiding the head of the screw to be seen when fixed on wood.