



**Technical and Test Institute
for Construction Prague**
Prosecká 811/76a
190 00 Prague
Czech Republic
eota@tzus.cz



Member of



www.eota.eu

European Technical Assessment

**ETA 24/0867
of 22/11/2024**

Technical Assessment Body issuing the ETA: Technical and Test Institute
for Construction Prague

Trade name of the construction product

MO-VH
MO-VHW
MO-VHS

**Product family to which the construction
product belongs**

Product area code: 33
Bonded injection type anchor for use in
cracked and uncracked concrete

Manufacturer

Index Técnicas Expansivas, S.L.
P.I. La Portalada II C/ Segador 13
26006 Logroño (La Rioja)
Spain
<https://www.indexfix.com/>

Manufacturing plant

Index Plant 1

**This European Technical Assessment
contains**

31 pages including 28 Annexes which form
an integral part of this assessment.

**This European Technical Assessment is
issued in accordance with regulation
(EU) No 305/2011, on the basis of**

EAD 330499-02-0601

Translations of this European Technical Assessment in other languages shall fully correspond to the original issued document and should be identified as such.

Communication of this European Technical Assessment, including transmission by electronic means, shall be in full (excepted the confidential Annex(es) referred to above). However, partial reproduction may be made, with the written consent of the issuing Technical Assessment Body - Technical and Test Institute for Construction Prague. Any partial reproduction has to be identified as such.

1. Technical description of the product

The MO-VH, MO-VHW (faster curing time) and MO-VHS (extended processing time) with steel elements is bonded anchor (injection type).

Steel elements can be galvanized or stainless steel threaded rod or rebar.

Steel element is placed into a drilled hole filled with injection mortar. The steel element is anchored via the bond between metal part, injection mortar and concrete.

The illustration and the description of the product are given in Annex A.

2. Specification of the intended use in accordance with the applicable EAD

The performances given in Section 3 are only valid if the anchor is used in compliance with the specifications and conditions given in Annex B.

The provisions made in this European Technical Assessment are based on an assumed working life of the anchor of 50 years and 100 years. The indications given on the working life cannot be interpreted as a guarantee given by the producer, but are to be regarded only as a means for choosing the products in relation to the expected economically reasonable working life of the works.

3. Performance of the product and references to the methods used for its assessment

3.1 Mechanical resistance and stability (BWR 1)

Essential characteristic	Performance
Characteristic resistance to tension load (static and quasi-static loading)	See Annex C 1 to C 11
Characteristic resistance to shear load (static and quasi-static loading)	See Annex C 12, C 13
Displacements under short-term and long-term loading	See Annex C 14
Characteristic resistance for seismic performance categories C1 and C2	See Annex C 15 to C 18

3.2 Safety in case of fire (BWR 2)

Essential characteristic	Performance
Reaction to fire	Satisfy the requirements for performance class A1
Resistance to fire	See Annex C 19, C 20

3.3 Hygiene, health and environment (BWR 3)

No performance determined.

3.4 General aspects relating to fitness for use

Durability and serviceability are only ensured if the specifications of intended use according to Annex B 1 are kept.

4. Assessment and verification of constancy of performance (AVCP) system applied with reference to its legal base

According to the Decision 96/582/EC of the European Commission¹ the system of assessment verification of constancy of performance (see Annex V to Regulation (EU) No 305/2011) given in the following table apply.

Product	Intended use	Level or class	System
Metal anchors for use in concrete	For fixing and/or supporting to concrete, structural elements (which contributes to the stability of the works) or heavy units	-	1

¹ Official Journal of the European Communities L 254 of 08.10.1996

5. Technical details necessary for the implementation of the AVCP system, as provided in the applicable EAD

The factory production control shall be in accordance with the control plan which is a part of the technical documentation of this European Technical Assessment. The control plan is laid down in the context of the factory production control system operated by the manufacturer and deposited at Technical and Test Institute for Construction Prague.² The results of factory production control shall be recorded and evaluated in accordance with the provisions of the control plan.

Issued in Prague on 22.11.2024

By
Ing. Jiří Studnička, Ph.D.
Head of the Technical Assessment Body

² The control plan is a confidential part of the documentation of the European Technical Assessment, but not published together with the ETA and only handed over to the approved body involved in the procedure of AVCP.

Threaded rod

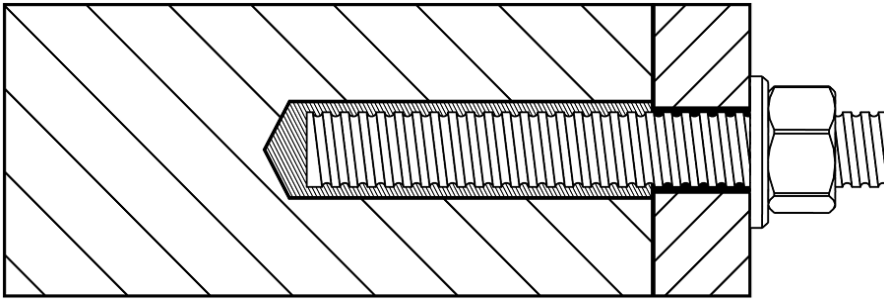

Reinforcing bar

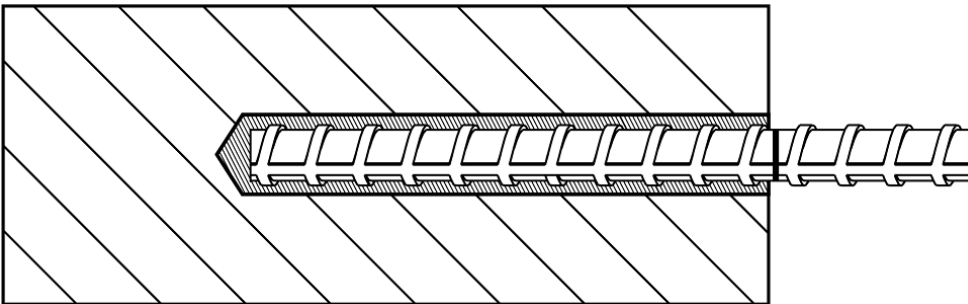

MO-VH, MO-VHW, MO-VHS

Product description
Installed conditions

Annex A 1

Coaxial cartridge (CC)

MO-VH, MO-VHW, MO-VHS

150 ml
380 ml
400 ml
410 ml

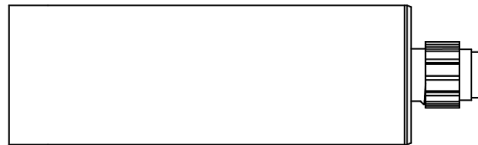

Side by side cartridge (SBS)

MO-VH, MO-VHW, MO-VHS

350 ml
360 ml
825 ml

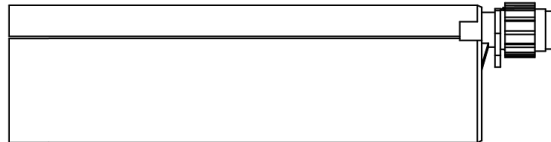

Two part foil in a single piston component cartridge (FCC)

MO-VH, MO-VHW, MO-VHS

150 ml
170 ml
300 ml
550 ml
850 ml



Marking of the mortar cartridges

Identifying mark of the producer, Trade name, Charge code number, Storage life, Curing and processing time

Mixing nozzle

KW



EZ-Flow



RM

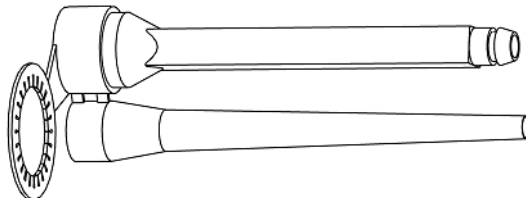

TB



Mixing nozzle TB is recommended for holes depth greater than 400 mm.

MO-VH, MO-VHW, MO-VHS

Product description
Injection system

Annex A 2

Threaded rod M8, M10, M12, M16, M20, M24, M27, M30

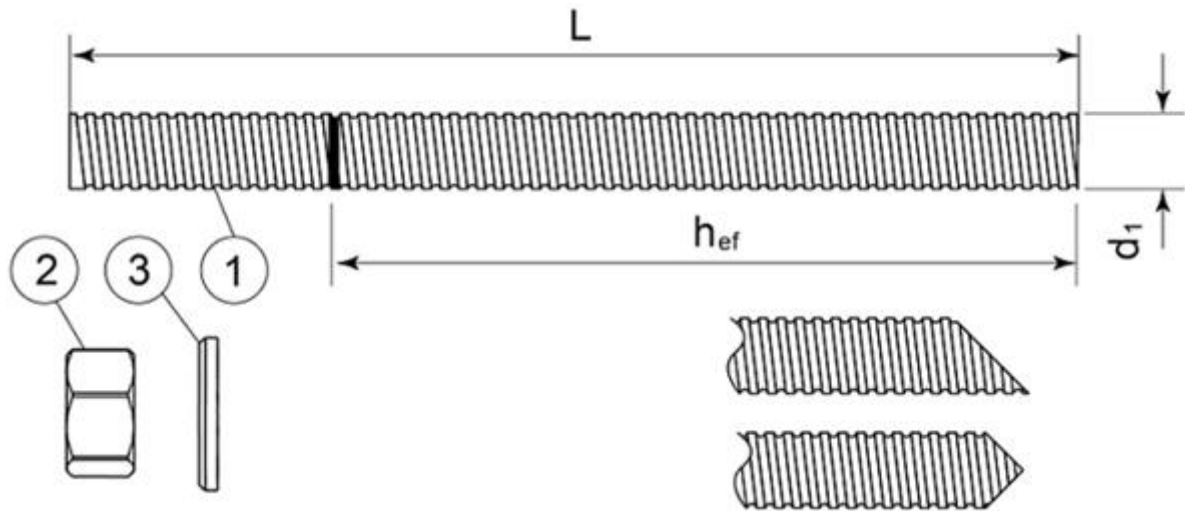

Standard commercial threaded rod with marked embedment depth

Part	Designation	Material
Steel, zinc plated $\geq 5 \mu\text{m}$ acc. to EN ISO 4042 or Steel, Hot-dip galvanized $\geq 40 \mu\text{m}$ acc. to EN ISO 1461 and EN ISO 10684 or Steel, zinc diffusion coating $\geq 15 \mu\text{m}$ acc. to EN 13811		
1	Anchor rod	Steel, EN 10087 or EN 10263 Property class 4.6, 5.8, 8.8, 10.9* EN ISO 898-1
2	Hexagon nut EN ISO 4032	According to threaded rod, EN 20898-2
3	Washer EN ISO 887, EN ISO 7089, EN ISO 7093 or EN ISO 7094	According to threaded rod
Stainless steel		
1	Anchor rod	Material: A2-70, A4-70, A4-80, EN ISO 3506
2	Hexagon nut EN ISO 4032	According to threaded rod
3	Washer EN ISO 887, EN ISO 7089, EN ISO 7093 or EN ISO 7094	According to threaded rod
High corrosion resistant steel		
1	Anchor rod	Material: 1.4529, 1.4565, EN 10088-1
2	Hexagon nut EN ISO 4032	According to threaded rod
3	Washer EN ISO 887, EN ISO 7089, EN ISO 7093 or EN ISO 7094	According to threaded rod

*Galvanized rod of high strength are sensitive to hydrogen induced brittle failure

MO-VH, MO-VHW, MO-VHS	Annex A 3
Product description Threaded rod and materials	

Rebar Ø8, Ø10, Ø12, Ø16, Ø20, Ø25, Ø32



Standard commercial reinforcing bar with marked embedment depth

Product form		Bars and de-coiled rods	
Class		B	C
Characteristic yield strength f_{yk} or $f_{0,2k}$ (MPa)		400 to 600	
Minimum value of $k = (f_t/f_y)_k$		$\geq 1,08$	$\geq 1,15$ < 1,35
Characteristic strain at maximum force ϵ_{uk} (%)		$\geq 5,0$	$\geq 7,5$
Bendability		Bend/Rebend test	
Maximum deviation from nominal mass (individual bar) (%)	Nominal bar size (mm)	$\pm 6,0$ $\pm 4,5$	
	≤ 8 > 8		
Bond: Minimum relative rib area, $f_{R,min}$	Nominal bar size (mm)	0,040 0,056	
	8 to 12 > 12		

MO-VH, MO-VHW, MO-VHS

Product description
Rebars and materials

Annex A 4

Specifications of intended use

Anchorage subject to:

- Static and quasi-static load
- Fire exposure
- Seismic actions category C1
- Seismic actions category C2: only threaded rod size M12, M16, M20

Base materials

- Cracked and uncracked concrete
- Reinforced or unreinforced normal weight concrete without fibres of strength class C20/25 at minimum and C50/60 at maximum according EN 206-1:2000-12

Temperature range:

- -40°C to +80°C (max. short. term temperature +80°C and max. long term temperature +50°C)

Use conditions (Environmental conditions)

- Structures subject to dry, internal conditions (all materials)
- For all other conditions according to EN 1993-1-4 corresponding to corrosion resistance class:
 - Stainless steel A2 according to Annex A 4, Table A1: CRC II
 - Stainless steel A4 according to Annex A 4, Table A1: CRC III
 - High corrosion resistance steel HCR according to Annex A 4, Table A1: CRC V

Concrete conditions:

- I1 – installation in dry or wet (water saturated) concrete and use in service in dry or wet concrete.
- I2 – installation in water-filled (not sea water) and use in service in dry or wet concrete

Design:

- The anchorages are designed in accordance with the EN 1992-4 under the responsibility of an engineer experienced in anchorages and concrete work.
- Verifiable calculation notes and drawings are prepared taking account of the loads to be anchored. The position of the anchor is indicated on the design drawings.
- Anchorages under seismic actions (cracked concrete) have to be designed in accordance with EN 1992-4.
- For applications with resistance to fire exposure, the fasteners are designed in accordance with EOTA TR 082 “Design of bonded fasteners in concrete under fire conditions”

Installation:

- Hole drilling by hammer drilling, dustless drilling or diamond core drilling mode.
- Anchor installation carried out by appropriately qualified personnel and under the supervision of the person responsible for technical matters of the site.

Installation direction:

- D3 – downward and horizontal and upwards (e.g. overhead) installation

MO-VH, MO-VHW, MO-VHS

Intended use
Specifications

Annex B 1

HDB – Hollow Drill Bit System

Heller Duster Expert hollow drill bit
 SDS-Plus ≤ 16mm
 SDS-Max ≥ 16mm



Class M vacuum
 Minimum flow rate 266 m³/h (74 l/s)

Cleaning brush

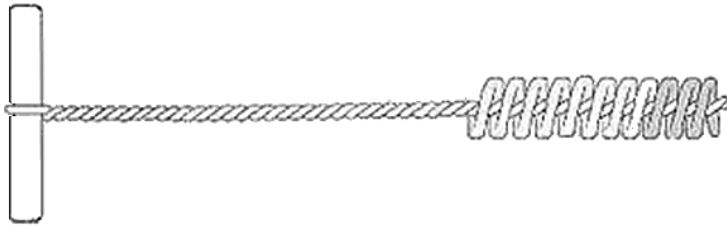

Applicator gun

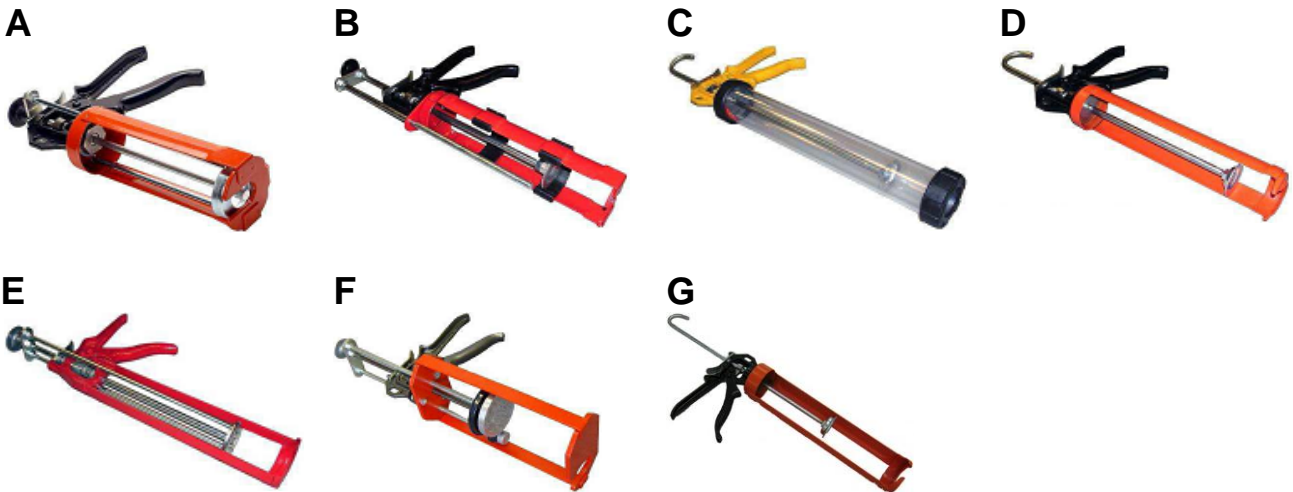

Applicator gun	A	B	C	D	E	F	G
Cartridge	Coaxial 380ml 400ml 410ml	Side by side 350ml 360ml	Foil capsule 150ml 300ml 550ml	Foil capsule 150ml 300ml	Coaxial 150ml	Side by side 825ml	Foil capsule 850ml

MO-VH, MO-VHW, MO-VHS

Intended use
 Hollow drill bit system, Cleaning brush
 Applicator guns

Annex B 2

SOLID SUBSTRATE INSTALLATION METHOD

1. Using the SDS hammer drill (HD) in rotary hammer mode for drilling, with a carbide tipped drill bit of the appropriate size, drill the hole to the specified hole diameter and depth.

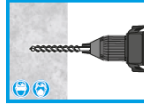

2. Select the correct air lance, insert to the bottom of the hole, and depress the trigger for 2 seconds. The compressed air must be clean and free from water and oil, with a minimum pressure of 90 psi (6 bar). A manual pump may be used for certain diameters and depths; check the approval document. Perform the blowing operation twice.

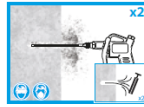

3. Select the correct size hole cleaning brush. Ensure that the brush is in good condition and of the correct diameter. Insert the brush to the bottom of the hole, using a brush extension if needed to reach the bottom. Withdraw with a twisting motion. There should be a positive interaction between the bristles of the brush and the sides of the drilled hole. Perform the brushing operation twice.



4. Repeat step 2 (blowing operation x2)

5. Repeat step 3 (brushing operation x2)

6. Repeat step 2 (blowing operation x2)

7. Select the most appropriate static mixer nozzle, checking that the mixing elements are present and fit for purpose. Never modify the mixer. Attach the mixer nozzle to the cartridge. Check the dispensing tool is in good working order. Place the cartridge into the dispensing tool.

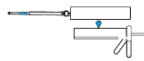

8. Extrude some resin to waste until an even coloured mixture is achieved. The cartridge is now ready for use.



9. Insert the mixing nozzle to the bottom of the hole. Extrude the resin and slowly withdraw the nozzle from the hole. Ensure no air voids are created as the nozzle is withdrawn. Inject resin until the hole is approximately 3/4 full and remove the nozzle from the hole.

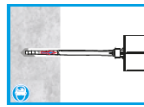

10. Select the steel anchor element ensuring it is free from oil or other contaminants, and mark with the required embedment depth. Insert the steel element into the hole using a back and forth twisting motion to ensure complete cover, until it reaches the bottom of the hole. Excess resin will be expelled from the hole evenly around the steel element and there shall be no gaps between the anchor element and the wall of the drilled hole.



11. Clean any excess resin from around the mouth of the hole.

12. Refer to the working and loading times within the tables to determine the appropriate cure time.

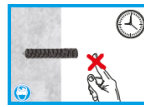

13. Position the fixture and tighten the anchor to the appropriate installation torque. Do not over-torque the anchor, as this could adversely affect its performance.

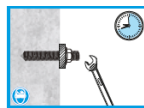

DEEP EMBEDMENT & OVERHEAD INSTALLATION METHOD

1a. Perform steps 1-8 under "solid substrate installation method".

2a. Attach the correct diameter and length extension tube to the nozzle. Select the correct diameter resin stopper for the application, then push and screw the extension tube into the resin stopper. This is held in place with a coarse internal thread. The resin stopper is a reusable accessory.

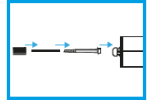

3a. Push the resin stopper and extension tube to the back of the drill hole.

4a. Ensure the extension tube is angled to allow free movement of the resin stopper as the resin is extruded.



5a. Continue from step 10 under "solid substrate installation method".

DIAMOND CORE DRILLING

1b. Using a diamond core drill (DD) and following the manufacturer's instructions, drill the specified diameter hole to the correct embedment depth then remove the concrete core.

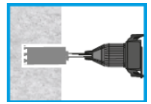

2b. Starting from the back of the hole, flush with pressurised water a minimum of two times and until there is only clean water.

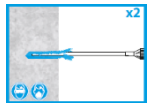

3b. Select the correct size hole cleaning brush. Ensure that the brush is in good condition and of the correct diameter. Insert the brush to the bottom of the hole, using a brush extension if needed to reach the bottom. Withdraw with a twisting motion. There should be a positive interaction between the bristles of the brush and the sides of the drilled hole. Perform the brushing operation twice.



4b. Repeat step 2b (flushing operation x2).

5b. Repeat step 3b (brushing operation x2).

6a. Using the correct air lance and starting from the back of the hole and withdrawing, perform a minimum of two blowing operations and ensure that the hole is clear of debris and excess water.



7a. Continue from step 7 under "solid substrate installation method".

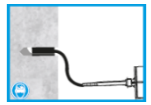

DUSTLESS DRILLING

1c. Using the specified hollow drill bit (HDB) and vacuum system and following the manufacturer's instructions, drill the specified diameter hole to the correct embedment depth. Ensure that the minimum vacuum specifications are met and that the vacuum is turned on.

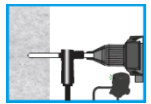

2c. The hole should be inspected to ensure the system has worked correctly. If the hole is clear of dust and debris, no further cleaning is required.

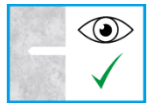

3c. Continue from step 7 under "solid substrate installation method".



MO-VH, MO-VHW, MO-VHS

Intended use
Installation procedure

Annex B 3

Table B1: Installation parameters of threaded rod

Size		M8	M10	M12	M16	M20	M24	M27	M30	
Nominal drill hole diameter	$\varnothing d_0$ [mm]	10	12	14	18	22	26	30	35	
Diameter of cleaning brush	d_b [mm]	14	14	20	20	29	29	40	40	
Manual pump cleaning		$h_{ef} < 300$ mm								
Torque moment	$\max T_{fix}$ [Nm]	10	20	40	80	150	200	240	275	
Depth of drill hole for $h_{ef,min}$	$h_0 = h_{ef}$ [mm]	40	40	48	64	80	96	108	120	
Depth of drill hole for $h_{ef,max}$	$h_0 = h_{ef}$ [mm]	160	200	240	320	400	480	540	600	
Minimum edge distance	c_{min} [mm]	35	40	50	65	80	96	110	120	
Minimum spacing	s_{min} [mm]	35	40	50	65	80	96	110	120	
Minimum thickness of member	h_{min} [mm]	$h_{ef} + 30$ mm \geq 100 mm					$h_{ef} + 2d_0$			

Table B2: Installation parameters of rebar

Size		$\varnothing 8$	$\varnothing 10$	$\varnothing 12$	$\varnothing 16$	$\varnothing 20$	$\varnothing 25$	$\varnothing 32$	
Nominal drill hole diameter	$\varnothing d_0$ [mm]	12	14	16	20	25	32	40	
Diameter of cleaning brush	d_b [mm]	14	14	19	22	29	40	42	
Manual pump cleaning		$h_{ef} < 300$ mm							
Depth of drill hole for $h_{ef,min}$	$h_0 = h_{ef}$ [mm]	40	40	48	64	80	100	128	
Depth of drill hole for $h_{ef,max}$	$h_0 = h_{ef}$ [mm]	160	200	240	320	400	500	640	
Minimum edge distance	c_{min} [mm]	35	40	50	65	80	100	130	
Minimum spacing	s_{min} [mm]	35	40	50	65	80	100	130	
Minimum thickness of member	h_{min} [mm]	$h_{ef} + 30$ mm \geq 100 mm					$h_{ef} + 2d_0$		

Table B3: Minimum curing time

MO-VH			
Resin cartridge temperature [°C]	T Work [mins]	Base material Temperature [°C]	T Load [mins]
+10	30 mins	-10 to -5	24 hours
+5	20 mins	-5 to 0	300 mins
0 to +5	15 mins	0 to +5	210 mins
+5 to +10	10 mins	+5 to +10	145 mins
+10 to +15	8 mins	+10 to +15	85 mins
+15 to +20	6 mins	+15 to +20	75 mins
+20 to +25	5 mins	+20 to +25	50 mins
+25 to +30	4 mins	+25 to +30	40 mins

MO-VHW			
Resin cartridge temperature [°C]	T Work [mins]	Base material Temperature [°C]	T Load [mins]
+20	40 mins	-20 to -15 ¹⁾	24 hours
+20	30 mins	-15 to -10 ¹⁾	18 hours
+5	20 mins	-10 to -5	12 hours
+5	15 mins	-5 to 0	100 mins
0 to +5	10 mins	0 to +5	75 mins
+5 to +20	5 mins	+5 to +20	50 mins
+20	100 second	+20	20 mins

¹⁾ characteristic values of resistance see Annex C 3 and C 6, seismic performance see Annex C 14

MO-VHS			
Resin cartridge temperature [°C]	T Work [mins]	Base material Temperature [°C]	T Load [mins]
+15 to +20	15 mins	+15 to +20	5 hours
+20 to +25	10 mins	+20 to +25	145 mins
+25 to +30	7.5 mins	+25 to +30	85 mins
+30 to +35	5 mins	+30 to +35	50 mins
+35 to +40	3.5 mins	+35 to +40	40 mins

T work is typical gel time at highest temperature

T load is set at the lowest temperature

MO-VH, MO-VHW, MO-VHS

Intended use
Installation parameters
Curing time

Annex B 4

Table C1: Design method EN 1992-4
Steel failure - Characteristic values of resistance to tension load of threaded rod

Steel failure – Characteristic resistance										
Size			M8	M10	M12	M16	M20	M24	M27	M30
Steel grade 4.6	$N_{Rk,s}$	[kN]	15	23	34	63	98	141	184	224
Partial safety factor	γ_{Ms}	[-]	2,00							
Steel grade 5.8	$N_{Rk,s}$	[kN]	18	29	42	79	123	177	230	281
Partial safety factor	γ_{Ms}	[-]	1,50							
Steel grade 8.8	$N_{Rk,s}$	[kN]	29	46	67	126	196	282	367	449
Partial safety factor	γ_{Ms}	[-]	1,50							
Steel grade 10.9	$N_{Rk,s}$	[kN]	37	58	84	157	245	353	459	561
Partial safety factor	γ_{Ms}	[-]	1,33							
Stainless steel grade A2-70, A4-70	$N_{Rk,s}$	[kN]	26	41	59	110	172	247	321	393
Partial safety factor	γ_{Ms}	[-]	1,87							
Stainless steel grade A4-80	$N_{Rk,s}$	[kN]	29	46	67	126	196	282	367	449
Partial safety factor	γ_{Ms}	[-]	1,60							
Stainless steel grade 1.4529	$N_{Rk,s}$	[kN]	26	41	59	110	172	247	321	393
Partial safety factor	γ_{Ms}	[-]	1,50							
Stainless steel grade 1.4565	$N_{Rk,s}$	[kN]	26	41	59	110	172	247	321	393
Partial safety factor	γ_{Ms}	[-]	1,87							

Table C2: Design method EN 1992-4
Steel failure - Characteristic values of resistance to tension load of rebar

Steel failure – Characteristic resistance									
Size			Ø8	Ø10	Ø12	Ø16	Ø20	Ø25	Ø32
Rebar BSt 500 S	$N_{Rk,s}$	[kN]	28	43	62	111	173	270	442
Partial safety factor	γ_{Ms}	[-]	1,4						

MO-VH, MO-VHW, MO-VHS

Performances
Steel failure characteristic resistance

Annex C 1

Table C3: Design method EN 1992-4

Characteristic values of resistance to tension load of threaded rod

Combined pullout and concrete cone failure in concrete C20/25										
Hammer drilling										
Size			M8	M10	M12	M16	M20	M24	M27	M30
Characteristic bond resistance in uncracked concrete for a working life of 50 years										
Dry and wet concrete	$\tau_{Rk,ucr}$	[N/mm ²]	13,0	11,1	11,1	10,2	9,9	7,7	6,8	6,6
Installation safety factor	γ_{inst}	[-]	1,0							
Flooded hole	$\tau_{Rk,ucr}$	[N/mm ²]	10,0	8,6	8,6	7,8	7,6	5,9	5,2	5,1
Installation safety factor	γ_{inst}	[-]	1,4							
Characteristic bond resistance in uncracked concrete for a working life of 100 years										
Dry and wet concrete	$\tau_{Rk,cr}$	[N/mm ²]	11,2	9,6	9,6	8,7	8,5	6,6	5,9	5,7
Installation safety factor	γ_{inst}	[-]	1,0							
Flooded hole	$\tau_{Rk,cr}$	[N/mm ²]	10,0	8,6	8,6	7,8	7,6	5,9	5,2	5,1
Installation safety factor	γ_{inst}	[-]	1,4							
Size			M8	M10	M12	M16	M20	M24	M27	M30
Characteristic bond resistance in cracked concrete for a working life of 50 years										
Dry and wet concrete	$\tau_{Rk,cr}$	[N/mm ²]	7,4	7,4	7,4	6,2	6,1	5,6	4,8	4,4
Installation safety factor	γ_{inst}	[-]	1,0							
Flooded hole	$\tau_{Rk,cr}$	[N/mm ²]	7,0	7,0	7,0	5,9	5,7	5,1	4,4	4,0
Installation safety factor	γ_{inst}	[-]	1,4							
Characteristic bond resistance in cracked concrete for a working life of 100 years										
Dry and wet concrete	$\tau_{Rk,cr}$	[N/mm ²]	3,9	3,9	3,9	3,6	3,5	3,1	2,7	2,4
Installation safety factor	γ_{inst}	[-]	1,0							
Flooded hole	$\tau_{Rk,cr}$	[N/mm ²]	4,5	4,5	4,5	4,2	4,0	3,7	3,1	2,8
Installation safety factor	γ_{inst}	[-]	1,4							
Dustless drilling										
Size			M8	M10	M12	M16	M20	M24	M27	M30
Characteristic bond resistance in uncracked concrete for a working life of 50 years and 100 years										
Dry and wet concrete	$\tau_{Rk,ucr}$	[N/mm ²]	13,0	11,1	11,1	10,2	9,9	7,7	6,8	6,6
Installation safety factor	γ_{inst}	[-]	1,2							
Flooded hole	$\tau_{Rk,ucr}$	[N/mm ²]	12,5	9,6	9,6	9,6	9,4	6,5	5,8	5,6
Installation safety factor	γ_{inst}	[-]	1,4							
Size			M8	M10	M12	M16	M20	M24	M27	M30
Characteristic bond resistance in cracked concrete for a working life of 50 years										
Dry and wet concrete	$\tau_{Rk,cr}$	[N/mm ²]	7,4	7,4	7,4	6,2	6,1	5,6	4,8	4,4
Installation safety factor	γ_{inst}	[-]	1,2							
Flooded hole	$\tau_{Rk,cr}$	[N/mm ²]	7,4	7,4	7,4	6,2	6,1	5,6	4,8	4,4
Installation safety factor	γ_{inst}	[-]	1,4							
Characteristic bond resistance in cracked concrete for a working life of 100 years										
Dry and wet concrete	$\tau_{Rk,cr}$	[N/mm ²]	4,5	4,5	4,5	4,2	4,0	3,7	3,1	2,8
Installation safety factor	γ_{inst}	[-]	1,2							
Flooded hole	$\tau_{Rk,cr}$	[N/mm ²]	4,5	4,5	4,5	4,2	4,0	3,7	3,1	2,8
Installation safety factor	γ_{inst}	[-]	1,4							
Factor for concrete	C25/30 C30/37 C35/45 C40/50 C45/55 C50/60	ψ_c								1,02 1,04 1,06 1,07 1,08 1,09
Factor for influence of sustained load for a working life 50 years	T1: 24°C / 40°C T2: 50°C / 80°C	ψ_{sus}^0								0,75 0,73

MO-VH, MO-VHW, MO-VHS

Performances

Hammer drilling, Dustless drilling

Characteristic resistance for tension loads - threaded rod

Annex C 2

Table C4: Design method EN 1992-4

Characteristic values of resistance to tension load of threaded rod for MO-VHW with installation temperature < -10°C

Combined pullout and concrete cone failure in concrete C20/25										
Hammer drilling										
Size		M8	M10	M12	M16	M20	M24	M27	M30	
Characteristic bond resistance in uncracked concrete for a working life of 50 years										
Dry and wet concrete	$\tau_{Rk,ucr}$	[N/mm ²]	12,4	10,6	10,6	9,7	9,4	7,3	6,5	6,3
Installation safety factor	γ_{inst}	[-]	1,0							
Flooded hole	$\tau_{Rk,ucr}$	[N/mm ²]	9,5	8,1	8,1	7,4	7,3	5,6	5,0	4,8
Installation safety factor	γ_{inst}	[-]	1,4							
Characteristic bond resistance in uncracked concrete for a working life of 100 years										
Dry and wet concrete	$\tau_{Rk,cr}$	[N/mm ²]	10,6	9,1	9,1	8,3	8,1	6,3	5,6	5,4
Installation safety factor	γ_{inst}	[-]	1,0							
Flooded hole	$\tau_{Rk,cr}$	[N/mm ²]	9,5	8,1	8,1	7,4	7,3	5,6	5,0	4,8
Installation safety factor	γ_{inst}	[-]	1,4							
Size		M8	M10	M12	M16	M20	M24	M27	M30	
Characteristic bond resistance in cracked concrete for a working life of 50 years										
Dry and wet concrete	$\tau_{Rk,cr}$	[N/mm ²]	7,1	7,1	7,1	5,9	5,8	5,3	4,6	4,1
Installation safety factor	γ_{inst}	[-]	1,0							
Flooded hole	$\tau_{Rk,cr}$	[N/mm ²]	6,6	6,6	6,6	5,6	5,4	4,9	4,2	3,8
Installation safety factor	γ_{inst}	[-]	1,4							
Characteristic bond resistance in cracked concrete for a working life of 100 years										
Dry and wet concrete	$\tau_{Rk,cr}$	[N/mm ²]	3,7	3,7	3,7	3,4	3,3	3,0	2,6	2,3
Installation safety factor	γ_{inst}	[-]	1,0							
Flooded hole	$\tau_{Rk,cr}$	[N/mm ²]	4,3	4,3	4,3	4,0	3,8	3,5	3,0	2,7
Installation safety factor	γ_{inst}	[-]	1,4							
Dustless drilling										
Size		M8	M10	M12	M16	M20	M24	M27	M30	
Characteristic bond resistance in uncracked concrete for a working life of 50 years and 100 years										
Dry and wet concrete	$\tau_{Rk,ucr}$	[N/mm ²]	12,4	10,6	10,6	9,7	9,4	7,3	6,5	6,3
Installation safety factor	γ_{inst}	[-]	1,2							
Flooded hole	$\tau_{Rk,ucr}$	[N/mm ²]	11,9	9,1	9,1	9,1	9,0	6,2	5,5	5,4
Installation safety factor	γ_{inst}	[-]	1,4							
Size		M8	M10	M12	M16	M20	M24	M27	M30	
Characteristic bond resistance in cracked concrete for a working life of 50 years										
Dry and wet concrete	$\tau_{Rk,cr}$	[N/mm ²]	7,1	7,1	7,1	5,9	5,8	5,3	4,6	4,1
Installation safety factor	γ_{inst}	[-]	1,2							
Flooded hole	$\tau_{Rk,cr}$	[N/mm ²]	7,1	7,1	7,1	5,9	5,8	5,3	4,6	4,1
Installation safety factor	γ_{inst}	[-]	1,4							
Characteristic bond resistance in cracked concrete for a working life of 100 years										
Dry and wet concrete	$\tau_{Rk,cr}$	[N/mm ²]	4,3	4,3	4,3	4,0	3,8	3,5	3,0	2,7
Installation safety factor	γ_{inst}	[-]	1,2							
Flooded hole	$\tau_{Rk,cr}$	[N/mm ²]	4,3	4,3	4,3	4,0	3,8	3,5	3,0	2,7
Installation safety factor	γ_{inst}	[-]	1,4							
Factor for concrete	C25/30	ψ_c	[-]	1,02						
	C30/37			1,04						
	C35/45			1,06						
	C40/50			1,07						
	C45/55			1,08						
C50/60	1,09									
Factor for influence of sustained load for a working life 50 years	T1: 24°C / 40°C	ψ_{sus}^0	[-]	0,75						
	T2: 50°C / 80°C			0,73						

MO-VHW

Performances

Hammer drilling, Dustless drilling
Characteristic resistance for tension loads - threaded rod

Annex C 3

Table C5: Design method EN 1992-4
Characteristic values of resistance to tension load of threaded rod

Concrete cone failure									
Size		M8	M10	M12	M16	M20	M24	M27	M30
Factor for concrete cone failure for uncracked concrete	$k_{Ucr,N}$	11							
Factor for concrete cone failure for cracked concrete	$k_{Cr,N}$	7,7							
Edge distance	$c_{Cr,N}$	1,5 h_{ef}							
Splitting failure									
Size		M8	M10	M12	M16	M20	M24	M27	M30
Edge distance	$c_{Cr,sp}$	1,5 h_{ef}							
Spacing	$s_{Cr,sp}$	3,0 h_{ef}							

MO-VH, MO-VHW, MO-VHS

Performances

Hammer drilling, Dustless drilling
Characteristic resistance for tension loads - threaded rod

Annex C 4

Table C6: Design method EN 1992-4
Characteristic values of resistance to tension load of rebar

Combined pullout and concrete cone failure in uncracked concrete C20/25									
Hammer drilling									
Size		Ø8	Ø10	Ø12	Ø16	Ø20	Ø25	Ø32	
Characteristic bond resistance in uncracked concrete for a working life of 50 years and 100 years									
Dry and wet concrete	$\tau_{Rk,ucr}$ [N/mm ²]	12,4	10,6	10,6	10,3	8,4	7,0	5,5	
Installation safety factor	γ_{inst} [-]	1,2							
Flooded hole	$\tau_{Rk,ucr}$ [N/mm ²]	12,4	10,6	10,6	10,3	8,4	7,0	5,5	
Installation safety factor	γ_{inst} [-]	1,4							
Size		Ø8	Ø10	Ø12	Ø16	Ø20	Ø25	Ø32	
Characteristic bond resistance in cracked concrete for a working life of 50 years									
Dry and wet concrete	$\tau_{Rk,ucr}$ [N/mm ²]	8,6	7,2	6,5	5,4	4,6	4,6	3,5	
Installation safety factor	γ_{inst} [-]	1,2							
Flooded hole	$\tau_{Rk,ucr}$ [N/mm ²]	8,6	7,2	6,5	5,4	4,6	4,6	3,5	
Installation safety factor	γ_{inst} [-]	1,4							
Characteristic bond resistance in cracked concrete for a working life of 100 years									
Dry and wet concrete	$\tau_{Rk,ucr}$ [N/mm ²]	5,0	4,1	4,1	3,5	3,0	3,0	2,3	
Installation safety factor	γ_{inst} [-]	1,2							
Flooded hole	$\tau_{Rk,ucr}$ [N/mm ²]	5,0	4,1	4,1	3,5	3,0	3,0	2,3	
Installation safety factor	γ_{inst} [-]	1,4							
Dustless drilling									
Size		Ø8	Ø10	Ø12	Ø16	Ø20	Ø25	Ø32	
Characteristic bond resistance in uncracked concrete for a working life of 50 years and 100 years									
Dry and wet concrete	$\tau_{Rk,ucr}$ [N/mm ²]	12,4	10,6	10,6	10,3	8,4	7,0	5,5	
Installation safety factor	γ_{inst} [-]	1,2							
Flooded hole	$\tau_{Rk,ucr}$ [N/mm ²]	11,6	9,4	9,4	9,0	7,4	6,0	4,7	
Installation safety factor	γ_{inst} [-]	1,4							
Size		Ø8	Ø10	Ø12	Ø16	Ø20	Ø25	Ø32	
Characteristic bond resistance in cracked concrete for a working life of 50 years									
Dry and wet concrete	$\tau_{Rk,ucr}$ [N/mm ²]	8,6	7,2	6,5	5,4	4,6	4,6	3,5	
Installation safety factor	γ_{inst} [-]	1,2							
Flooded hole	$\tau_{Rk,ucr}$ [N/mm ²]	8,6	7,2	6,5	5,4	4,6	4,6	3,5	
Installation safety factor	γ_{inst} [-]	1,4							
Characteristic bond resistance in cracked concrete for a working life of 100 years									
Dry and wet concrete	$\tau_{Rk,ucr}$ [N/mm ²]	5,0	4,1	4,1	3,5	3,0	3,0	2,3	
Installation safety factor	γ_{inst} [-]	1,2							
Flooded hole	$\tau_{Rk,ucr}$ [N/mm ²]	5,0	4,1	4,1	3,5	3,0	3,0	2,3	
Installation safety factor	γ_{inst} [-]	1,4							
Factor for concrete	C25/30	ψ_c	[-]						1,02
	C30/37			1,04					
	C35/45			1,06					
	C40/50			1,07					
	C45/55			1,08					
	C50/60			1,09					
Factor for influence of sustained load for a working life 50 years	T1: 24°C / 40°C	ψ_{sus}^0	[-]						0,75
	T2: 50°C / 80°C			0,73					

MO-VH, MO-VHW, MO-VHS

Performances
Hammer drilling, Dustless drilling
Characteristic resistance for tension loads - rebar

Annex C 5

Table C7: Design method EN 1992-4
 Characteristic values of resistance to tension load of rebar
 MO-VHW with installation temperature < -10°C

Combined pullout and concrete cone failure in uncracked concrete C20/25										
Hammer drilling										
Size			Ø8	Ø10	Ø12	Ø16	Ø20	Ø25	Ø32	
Characteristic bond resistance in uncracked concrete for a working life of 50 years and 100 years										
Dry and wet concrete	$\tau_{RK,ucr}$	[N/mm ²]	11,8	10,1	10,1	9,8	8,0	6,7	5,2	
Installation safety factor	γ_{inst}	[-]	1,2							
Flooded hole	$\tau_{RK,ucr}$	[N/mm ²]	11,8	10,1	10,1	9,8	8,0	6,7	5,2	
Installation safety factor	γ_{inst}	[-]	1,4							
Size			Ø8	Ø10	Ø12	Ø16	Ø20	Ø25	Ø32	
Characteristic bond resistance in cracked concrete for a working life of 50 years										
Dry and wet concrete	$\tau_{RK,ucr}$	[N/mm ²]	8,2	6,8	6,2	5,2	4,4	4,4	3,3	
Installation safety factor	γ_{inst}	[-]	1,2							
Flooded hole	$\tau_{RK,ucr}$	[N/mm ²]	8,2	6,8	6,2	5,2	4,4	4,4	3,3	
Installation safety factor	γ_{inst}	[-]	1,4							
Characteristic bond resistance in cracked concrete for a working life of 100 years										
Dry and wet concrete	$\tau_{RK,ucr}$	[N/mm ²]	4,8	3,9	3,9	3,3	2,8	2,8	2,1	
Installation safety factor	γ_{inst}	[-]	1,2							
Flooded hole	$\tau_{RK,ucr}$	[N/mm ²]	4,8	3,9	3,9	3,3	2,8	2,8	2,1	
Installation safety factor	γ_{inst}	[-]	1,4							
Dustless drilling										
Size			Ø8	Ø10	Ø12	Ø16	Ø20	Ø25	Ø32	
Characteristic bond resistance in uncracked concrete for a working life of 50 years and 100 years										
Dry and wet concrete	$\tau_{RK,ucr}$	[N/mm ²]	11,8	10,1	10,1	9,8	8,0	6,7	5,2	
Installation safety factor	γ_{inst}	[-]	1,2							
Flooded hole	$\tau_{RK,ucr}$	[N/mm ²]	11,1	9,0	9,0	8,6	7,0	5,5	4,4	
Installation safety factor	γ_{inst}	[-]	1,4							
Size			Ø8	Ø10	Ø12	Ø16	Ø20	Ø25	Ø32	
Characteristic bond resistance in cracked concrete for a working life of 50 years										
Dry and wet concrete	$\tau_{RK,ucr}$	[N/mm ²]	8,2	6,8	6,2	5,2	4,4	4,4	3,3	
Installation safety factor	γ_{inst}	[-]	1,2							
Flooded hole	$\tau_{RK,ucr}$	[N/mm ²]	8,2	6,8	6,2	5,2	4,4	4,4	3,3	
Installation safety factor	γ_{inst}	[-]	1,4							
Characteristic bond resistance in cracked concrete for a working life of 100 years										
Dry and wet concrete	$\tau_{RK,ucr}$	[N/mm ²]	4,8	3,9	3,9	3,3	2,8	2,8	2,1	
Installation safety factor	γ_{inst}	[-]	1,2							
Flooded hole	$\tau_{RK,ucr}$	[N/mm ²]	4,8	3,9	3,9	3,3	2,8	2,8	2,1	
Installation safety factor	γ_{inst}	[-]	1,4							
Factor for concrete	C25/30 C30/37 C35/45 C40/50 C45/55 C50/60	ψ_c	[-]	1,02 1,04 1,06 1,07 1,08 1,09						
Factor for influence of sustained load for a working life 50 years	T1: 24°C / 40°C T2: 50°C / 80°C	ψ_{sus}^0	[-]	0,75 0,73						

MO-VHW

Performances

Hammer drilling, Dustless drilling
 Characteristic resistance for tension loads - rebar

Annex C 6

Table C8: Design method EN 1992-4
 Characteristic values of resistance to tension load of rebar

Concrete cone failure									
Factor for concrete cone failure	$k_{ucr,N}$	[-]						11	
Edge distance	$c_{cr,N}$	[mm]						$1,5h_{ef}$	
Splitting failure									
Size			$\emptyset 8$	$\emptyset 10$	$\emptyset 12$	$\emptyset 16$	$\emptyset 20$	$\emptyset 25$	$\emptyset 32$
Edge distance	$c_{cr,sp}$	[mm]						$1,5h_{ef}$	
Spacing	$s_{cr,sp}$	[mm]						$3,0h_{ef}$	

MO-VH, MO-VHW, MO-VHS

Performances
 Hammer drilling, Dustless drilling
 Characteristic resistance for tension loads - rebar

Annex C 7

Table C9: Design method EN 1992-4

Characteristic values of resistance to tension load of threaded rod

Combined pullout and concrete cone failure in concrete C20/25										
Diamond core drilling										
Size		M8	M10	M12	M16	M20	M24	M27	M30	
Characteristic bond resistance in uncracked concrete for a working life of 50 years and 100 years										
Dry and wet concrete	$\tau_{Rk,ucr}$	[N/mm ²]	11,0	10,0	10,0	9,0	8,5	8,0	6,5	5,5
Installation safety factor	γ_{inst}	[-]	1,0							
Flooded hole	$\tau_{Rk,ucr}$	[N/mm ²]	11,0	10,0	10,0	9,0	8,5	8,0	6,5	5,5
Installation safety factor	γ_{inst}	[-]	1,4							
Size		M10	M12	M16	M20	M24				
Characteristic bond resistance in cracked concrete for a working life of 50 years										
Dry and wet concrete	$\tau_{Rk,cr}$	[N/mm ²]	6,0	6,5	5,5	5,5	5,5	5,5		
Installation safety factor	γ_{inst}	[-]	1,0							
Flooded hole	$\tau_{Rk,cr}$	[N/mm ²]	6,0	6,5	5,5	5,5	5,5	5,5		
Installation safety factor	γ_{inst}	[-]	1,4							
Characteristic bond resistance in cracked concrete for a working life of 100 years										
Dry and wet concrete	$\tau_{Rk,cr}$	[N/mm ²]	5,0	5,0	4,0	4,5	4,5			
Installation safety factor	γ_{inst}	[-]	1,0							
Flooded hole	$\tau_{Rk,cr}$	[N/mm ²]	5,0	5,0	4,0	4,5	4,5			
Installation safety factor	γ_{inst}	[-]	1,4							
Factor for concrete	C25/30	ψ_c	[-]	1,02						
	C30/37			1,04						
	C35/45			1,06						
	C40/50			1,07						
	C45/55			1,08						
	C50/60			1,09						
Factor for influence of sustained load for a working life 50 years	ψ_{sus}^0	[-]	0,77							
Concrete cone failure										
Factor for concrete cone failure for uncracked concrete	$k_{ucr,N}$	[-]	11							
Factor for concrete cone failure for cracked concrete	$k_{cr,N}$		7,7							
Edge distance	$c_{cr,N}$	[mm]	1,5 _{hef}							
Splitting failure										
Size		M8	M10	M12	M16	M20	M24	M27	M30	
Edge distance	$c_{cr,sp}$	[mm]	1,5 _{hef}							
Spacing	$s_{cr,sp}$	[mm]	3,0 _{hef}							

MO-VH, MO-VHW, MO-VHS

Performances

Diamond core drilling

Characteristic resistance for tension loads - threaded rod

Annex C 8

Table C10: Design method EN 1992-4

Characteristic values of resistance to tension load of threaded rod for MO-VHW with installation temperature < -10°C

Combined pullout and concrete cone failure in concrete C20/25									
Diamond core drilling									
Size		M8	M10	M12	M16	M20	M24	M27	M30
Characteristic bond resistance in uncracked concrete for a working life of 50 years and 100 years									
Dry and wet concrete	$\tau_{Rk,ucr}$ [N/mm ²]	10,0	10,0	10,0	8,5	8,0	7,5	6,0	5,0
Installation safety factor	γ_{inst} [-]	1,0							
Flooded hole	$\tau_{Rk,ucr}$ [N/mm ²]	10,0	10,0	10,0	8,5	8,0	7,5	6,0	5,0
Installation safety factor	γ_{inst} [-]	1,4							
Size		M10	M12	M16	M20	M24			
Characteristic bond resistance in cracked concrete for a working life of 50 years									
Dry and wet concrete	$\tau_{Rk,cr}$ [N/mm ²]	5,5	6,0	5,0	5,5	5,0			
Installation safety factor	γ_{inst} [-]	1,0							
Flooded hole	$\tau_{Rk,cr}$ [N/mm ²]	5,5	6,0	5,0	5,5	5,0			
Installation safety factor	γ_{inst} [-]	1,4							
Characteristic bond resistance in cracked concrete for a working life of 100 years									
Dry and wet concrete	$\tau_{Rk,cr}$ [N/mm ²]	5,0	5,0	4,0	4,0	4,0			
Installation safety factor	γ_{inst} [-]	1,0							
Flooded hole	$\tau_{Rk,cr}$ [N/mm ²]	5,0	5,0	4,0	4,0	4,0			
Installation safety factor	γ_{inst} [-]	1,4							
Factor for cracked and uncracked concrete	C25/30	ψ_c	[-]	1,02					
	C30/37			1,04					
	C35/45			1,06					
	C40/50			1,07					
	C45/55			1,08					
	C50/60			1,09					
Factor for influence of sustained load for a working life 50 years	$\psi^{0_{sus}}$	[-]	0,77						
Concrete cone failure									
See Annex C 8									
Splitting failure									
See Annex C 8									

MO-VHW

Performances

Diamond core drilling
Characteristic resistance for tension loads - threaded rod

Annex C 9

Table C11: Design method EN 1992-4
Characteristic values of resistance to tension load of rebar

Combined pullout and concrete cone failure in uncracked concrete C20/25										
Diamond core drilling										
Size			Ø8	Ø10	Ø12	Ø16	Ø20	Ø25	Ø32	
Characteristic bond resistance in uncracked concrete for a working life of 50 years and 100 years										
Dry and wet concrete	$\tau_{Rk,ucr}$	[N/mm ²]	10,0	9,5	9,0	8,5	8,0	6,5	4,0	
Installation safety factor	γ_{inst}	[-]	1,2							
Flooded hole	$\tau_{Rk,ucr}$	[N/mm ²]	10,0	9,5	9,0	8,5	8,0	6,0	3,5	
Installation safety factor	γ_{inst}	[-]	1,4							
Size			Ø10	Ø12	Ø16	Ø20	Ø25			
Characteristic bond resistance in cracked concrete for a working life of 50 years										
Dry and wet concrete	$\tau_{Rk,cr}$	[N/mm ²]	5,5	6,0	5,0	5,5	4,5			
Installation safety factor	γ_{inst}	[-]	1,2							
Flooded hole	$\tau_{Rk,cr}$	[N/mm ²]	5,5	6,0	5,0	5,5	4,5			
Installation safety factor	γ_{inst}	[-]	1,4							
Characteristic bond resistance in cracked concrete for a working life of 100 years										
Dry and wet concrete	$\tau_{Rk,cr}$	[N/mm ²]	5,0	4,5	4,0	4,5	3,5			
Installation safety factor	γ_{inst}	[-]	1,2							
Flooded hole	$\tau_{Rk,cr}$	[N/mm ²]	5,0	4,5	4,0	4,5	3,5			
Installation safety factor	γ_{inst}	[-]	1,4							
Factor for cracked and uncracked concrete	C25/30	ψ_c	[-]	1,02						
	C30/37			1,04						
	C35/45			1,06						
	C40/50			1,07						
	C45/55			1,08						
	C50/60			1,09						
Factor for influence of sustained load for a working life 50 years	ψ^0_{sus}	[-]	0,77							
Concrete cone failure										
Factor for concrete cone failure for uncracked concrete	$k_{ucr,N}$	[-]	11							
Factor for concrete cone failure for cracked concrete	$k_{cr,N}$		7,7							
Edge distance	$c_{cr,N}$	[mm]	1,5h _{ef}							
Splitting failure										
Size			Ø8	Ø10	Ø12	Ø16	Ø20	Ø25	Ø32	
Edge distance	$c_{cr,sp}$	[mm]	1,5h _{ef}							
Spacing	$s_{cr,sp}$	[mm]	3,0h _{ef}							
MO-VH, MO-VHW, MO-VHS							Annex C 10			
Performances										
Diamond core drilling Characteristic resistance for tension loads - rebar										

Table C12: Design method EN 1992-4
 Characteristic values of resistance to tension load of rebar for
 MO-VHW with installation temperature < -10°C

Combined pullout and concrete cone failure in uncracked concrete C20/25										
Diamond core drilling										
Size			Ø8	Ø10	Ø12	Ø16	Ø20	Ø25	Ø32	
Characteristic bond resistance in uncracked concrete for a working life of 50 years and 100 years										
Dry and wet concrete	$\tau_{Rk,ucr}$ [N/mm ²]		10,0	9,0	8,5	8,0	7,5	6,5	4,0	
Installation safety factor	γ_{inst} [-]		1,2							
Flooded hole	$\tau_{Rk,ucr}$ [N/mm ²]		10,0	9,0	8,5	8,0	7,5	5,5	3,5	
Installation safety factor	γ_{inst} [-]		1,4							
Size			Ø10	Ø12	Ø16	Ø20	Ø25			
Characteristic bond resistance in cracked concrete for a working life of 50 years										
Dry and wet concrete	$\tau_{Rk,cr}$ [N/mm ²]		5,5	5,5	5,0	5,5	4,0			
Installation safety factor	γ_{inst} [-]		1,2							
Flooded hole	$\tau_{Rk,cr}$ [N/mm ²]		5,5	5,5	5,0	5,5	4,0			
Installation safety factor	γ_{inst} [-]		1,4							
Characteristic bond resistance in cracked concrete for a working life of 100 years										
Dry and wet concrete	$\tau_{Rk,cr}$ [N/mm ²]		5,0	4,5	3,5	4,0	3,0			
Installation safety factor	γ_{inst} [-]		1,2							
Flooded hole	$\tau_{Rk,cr}$ [N/mm ²]		5,0	4,5	3,5	4,0	3,0			
Installation safety factor	γ_{inst} [-]		1,4							
Factor for cracked and uncracked concrete	C25/30 C30/37 C35/45 C40/50 C45/55 C50/60	ψ_c [-]					1,02 1,04 1,06 1,07 1,08 1,09			
Factor for influence of sustained load for a working life 50 years		$\psi^{0_{sus}}$ [-]					0,77			
Concrete cone failure										
See Annex C 10										
Splitting failure										
See Annex C 10										

MO-VHW

Performances
 Diamond core drilling
 Characteristic resistance for tension loads - rebar

Annex C 11

Table C13: Design method EN 1992-4
Characteristic values of resistance to shear load of threaded rod

Steel failure without lever arm									
Size		M8	M10	M12	M16	M20	M24	M27	M30
Steel grade 4.6	$V_{Rk,s}$ [kN]	7	12	17	31	49	71	92	112
Partial safety factor	γ_{Ms} [-]	1,67							
Steel grade 5.8	$V_{Rk,s}$ [kN]	9	15	21	39	61	88	115	140
Partial safety factor	γ_{Ms} [-]	1,25							
Steel grade 8.8	$V_{Rk,s}$ [kN]	15	23	34	63	98	141	184	224
Partial safety factor	γ_{Ms} [-]	1,25							
Steel grade 10.9	$V_{Rk,s}$ [kN]	18	29	42	79	123	177	230	281
Partial safety factor	γ_{Ms} [-]	1,5							
Stainless steel grade A2-70, A4-70	$V_{Rk,s}$ [kN]	13	20	30	55	86	124	161	196
Partial safety factor	γ_{Ms} [-]	1,56							
Stainless steel grade A4-80	$V_{Rk,s}$ [kN]	15	23	34	63	98	141	184	224
Partial safety factor	γ_{Ms} [-]	1,33							
Stainless steel grade 1.4529	$V_{Rk,s}$ [kN]	13	20	30	55	86	124	161	196
Partial safety factor	γ_{Ms} [-]	1,25							
Stainless steel grade 1.4565	$V_{Rk,s}$ [kN]	13	20	30	55	86	124	161	196
Partial safety factor	γ_{Ms} [-]	1,56							
Characteristic resistance of group of fasteners									
Ductility factor $k_7 = 1,0$ for steel with rupture elongation $A_5 > 8\%$									

Steel failure with lever arm									
Size		M8	M10	M12	M16	M20	M24	M27	M30
Steel grade 4.6	$M^o_{Rk,s}$ [N.m]	15	30	52	133	260	449	666	900
Partial safety factor	γ_{Ms} [-]	1,67							
Steel grade 5.8	$M^o_{Rk,s}$ [N.m]	19	37	66	166	325	561	832	1125
Partial safety factor	γ_{Ms} [-]	1,25							
Steel grade 8.8	$M^o_{Rk,s}$ [N.m]	30	60	105	266	519	898	1332	1799
Partial safety factor	γ_{Ms} [-]	1,25							
Steel grade 10.9	$M^o_{Rk,s}$ [N.m]	37	75	131	333	649	1123	1664	2249
Partial safety factor	γ_{Ms} [-]	1,50							
Stainless steel grade A2-70, A4-70	$M^o_{Rk,s}$ [N.m]	26	52	92	233	454	786	1165	1574
Partial safety factor	γ_{Ms} [-]	1,56							
Stainless steel grade A4-80	$M^o_{Rk,s}$ [N.m]	30	60	105	266	519	898	1332	1799
Partial safety factor	γ_{Ms} [-]	1,33							
Stainless steel grade 1.4529	$M^o_{Rk,s}$ [N.m]	26	52	92	233	454	786	1165	1574
Partial safety factor	γ_{Ms} [-]	1,25							
Stainless steel grade 1.4565	$M^o_{Rk,s}$ [N.m]	26	52	92	233	454	786	1165	1574
Partial safety factor	γ_{Ms} [-]	1,56							
Concrete pry-out failure									
Factor for resistance to pry-out failure	k_8 [-]	2							

Concrete edge failure									
Size		M8	M10	M12	M16	M20	M24	M27	M30
Outside diameter of fastener	d_{nom} [mm]	8	10	12	16	20	24	27	30
Effective length of fastener	l_f [mm]	min (h_{ef} , 8 d_{nom})							

MO-VH, MO-VHW, MO-VHS

Performances

Design according to EN 1992-4
Characteristic resistance for shear loads - threaded rod

Annex C 12

Table C14: Design method EN 1992-4
Characteristic values of resistance to shear load of rebar

Steel failure without lever arm								
Size		Ø8	Ø10	Ø12	Ø16	Ø20	Ø25	Ø32
Rebar BSt 500 S	$V_{Rk,s}$ [kN]	14	22	31	55	86	135	221
Partial safety factor	γ_{Ms} [-]	1,5						
Characteristic resistance of group of fasteners								
Ductility factor $k_7 = 1,0$ for steel with rupture elongation $A_5 > 8\%$								

Steel failure with lever arm								
Size		Ø8	Ø10	Ø12	Ø16	Ø20	Ø25	Ø32
Rebar BSt 500 S	$M^o_{Rk,s}$ [N.m]	33	65	112	265	518	1013	2122
Partial safety factor	γ_{Ms} [-]	1,5						
Concrete pry-out failure								
Factor for resistance to pry-out failure	k_8 [-]	2						

Concrete edge failure								
Size		Ø8	Ø10	Ø12	Ø16	Ø20	Ø25	Ø32
Outside diameter of fastener	d_{nom} [mm]	8	10	12	16	20	25	32
Effective length of fastener	l_f [mm]	min (h_{ef} , 8 d_{nom})						

MO-VH, MO-VHW, MO-VHS

Performances

Design according to EN 1992-4
Characteristic resistance for shear loads - rebar

Annex C 13

Table C15: Displacement of threaded rod under tension and shear load - Hammer drilling, dustless drilling

Size		M8	M10	M12	M16	M20	M24	M27	M30
Tension load									
Uncracked concrete									
δ_{N0}	[mm/kN]	0,03	0,03	0,03	0,03	0,02	0,02	0,02	0,02
$\delta_{N\infty}$	[mm/kN]	0,12	0,11	0,08	0,05	0,03	0,03	0,02	0,02
Cracked concrete									
δ_{N0}	[mm/kN]	0,09	0,08	0,07	0,07	0,05	0,04	0,04	0,04
$\delta_{N\infty}$	[mm/kN]	0,64	0,51	0,36	0,25	0,15	0,11	0,10	0,09
Shear load									
δ_{V0}	[mm/kN]	0,48	0,30	0,20	0,11	0,10	0,08	0,06	0,05
$\delta_{V\infty}$	[mm/kN]	0,72	0,45	0,30	0,17	0,14	0,12	0,10	0,08

Table C16: Displacement of threaded rod under tension and shear load - Diamond core drilling

Size		M8	M10	M12	M16	M20	M24	M27	M30
Tension load									
Uncracked concrete									
δ_{N0}	[mm/kN]	0,02	0,02	0,03	0,02	0,01	0,01	0,02	0,02
$\delta_{N\infty}$	[mm/kN]	0,11	0,07	0,05	0,03	0,02	0,02	0,02	0,02
Cracked concrete									
δ_{N0}	[mm/kN]	/	0,07	0,05	0,05	0,03	0,03	/	/
$\delta_{N\infty}$	[mm/kN]	/	0,37	0,23	0,16	0,10	0,07	/	/
Shear load									
δ_{V0}	[mm/kN]	0,48	0,30	0,20	0,11	0,10	0,08	0,06	0,05
$\delta_{V\infty}$	[mm/kN]	0,72	0,45	0,30	0,17	0,14	0,12	0,10	0,08

Table C17: Displacement of rebar under tension and shear load - Hammer drilling, dustless drilling

Size		Ø8	Ø10	Ø12	Ø16	Ø20	Ø25	Ø32
Tension load								
Uncracked concrete								
δ_{N0}	[mm/kN]	0,04	0,04	0,03	0,03	0,03	0,03	0,02
$\delta_{N\infty}$	[mm/kN]	0,12	0,12	0,08	0,05	0,04	0,03	0,03
Cracked concrete								
δ_{N0}	[mm/kN]	0,08	0,09	0,09	0,06	0,06	0,04	0,04
$\delta_{N\infty}$	[mm/kN]	0,52	0,50	0,38	0,25	0,19	0,13	0,11
Shear load								
δ_{V0}	[mm/kN]	0,05	0,04	0,03	0,02	0,01	0,01	0,01
$\delta_{V\infty}$	[mm/kN]	0,08	0,06	0,05	0,03	0,02	0,01	0,01

Table C18: Displacement of rebar under tension and shear load - Diamond core drilling

Size		Ø8	Ø10	Ø12	Ø16	Ø20	Ø25	Ø32
Tension load								
Uncracked concrete								
δ_{N0}	[mm/kN]	0,04	0,04	0,03	0,02	0,02	0,02	0,02
$\delta_{N\infty}$	[mm/kN]	0,10	0,07	0,05	0,03	0,02	0,02	0,02
Cracked concrete								
δ_{N0}	[mm/kN]	/	0,07	0,06	0,04	0,03	0,03	/
$\delta_{N\infty}$	[mm/kN]	/	0,34	0,23	0,16	0,09	0,07	/
Shear load								
δ_{V0}	[mm/kN]	0,05	0,04	0,03	0,02	0,01	0,01	0,01
$\delta_{V\infty}$	[mm/kN]	0,08	0,06	0,05	0,03	0,02	0,01	0,01

MO-VH, MO-VHW, MO-VHS

Performances
Displacement

Annex C 14

Table C19: Seismic performance category C1 of threaded rod - Hammer drilling, Dustless drilling

Size			M8	M10	M12	M16	M20	M24	M27	M30
Tension load										
Steel failure										
Characteristic resistance grade 4.6	$N_{Rk,s,C1}$	[kN]	15	23	34	63	98	141	184	224
Partial safety factor	γ_{Ms}	[-]	2,00							
Characteristic resistance grade 5.8	$N_{Rk,s,C1}$	[kN]	18	29	42	79	123	177	230	281
Partial safety factor	γ_{Ms}	[-]	1,50							
Characteristic resistance grade 8.8	$N_{Rk,s,C1}$	[kN]	29	46	67	126	196	282	367	449
Partial safety factor	γ_{Ms}	[-]	1,50							
Characteristic resistance grade 10.9	$N_{Rk,s,C1}$	[kN]	/	58	84	157	245	353	/	/
Partial safety factor	γ_{Ms}	[-]	1,33							
Characteristic resistance A2-70, A4-70	$N_{Rk,s,C1}$	[kN]	26	41	59	110	172	247	321	393
Partial safety factor	γ_{Ms}	[-]	1,87							
Characteristic resistance A4-80	$N_{Rk,s,C1}$	[kN]	29	46	67	126	196	282	367	449
Partial safety factor	γ_{Ms}	[-]	1,60							
Characteristic resistance 1.4529	$N_{Rk,s,C1}$	[kN]	26	41	59	110	172	247	321	393
Partial safety factor	γ_{Ms}	[-]	1,50							
Characteristic resistance 1.4565	$N_{Rk,s,C1}$	[kN]	26	41	59	110	172	247	321	393
Partial safety factor	γ_{Ms}	[-]	1,87							
Characteristic resistance to pull-out for a working life of 50 years										
Dry, wet concrete and flooded hole	$\tau_{Rk,C1}$	[N/mm ²]	4,5	5,5	5,5	5,5	4,2	5,0	2,3	1,8
Characteristic resistance to pull-out for a working life of 100 years										
Dry, wet concrete and flooded hole	$\tau_{Rk,C1}$	[N/mm ²]	2,9	3,8	3,8	4,0	2,6	3,8	1,6	1,2
Installation safety factor – Dry and wet concrete	γ_{inst}	[-]	1,2							
Installation safety factor – Flooded hole	γ_{inst}	[-]	1,4							
Shear load										
Steel failure without lever arm										
Characteristic resistance grade 4.6	$V_{Rk,s,C1}$	[kN]	6	7	10	23	30	40	43	54
Partial safety factor	γ_{Ms}	[-]	1,67							
Characteristic resistance grade 5.8	$V_{Rk,s,C1}$	[kN]	7	9	13	28	38	51	54	67
Partial safety factor	γ_{Ms}	[-]	1,25							
Characteristic resistance grade 8.8	$V_{Rk,s,C1}$	[kN]	11	14	21	45	61	81	86	108
Partial safety factor	γ_{Ms}	[-]	1,25							
Characteristic resistance grade 10.9	$V_{Rk,s,C1}$	[kN]	/	18	26	56	76	101	/	/
Partial safety factor	γ_{Ms}	[-]	1,50							
Characteristic resistance A2-70, A4-70	$V_{Rk,s,C1}$	[kN]	10	12	18	39	53	71	76	94
Partial safety factor	γ_{Ms}	[-]	1,56							
Characteristic resistance A4-80	$V_{Rk,s,C1}$	[kN]	11	14	21	45	61	81	86	108
Partial safety factor	γ_{Ms}	[-]	1,33							
Characteristic resistance 1.4529	$V_{Rk,s,C1}$	[kN]	10	12	18	39	53	71	76	94
Partial safety factor	γ_{Ms}	[-]	1,25							
Characteristic resistance 1.4565	$V_{Rk,s,C1}$	[kN]	10	12	18	39	53	71	76	94
Partial safety factor	γ_{Ms}	[-]	1,56							
Characteristic shear load resistance $V_{Rk,s,eq}$ in the Table C19 shall be multiplied by following reduction factor for hot-dip galvanized commercial standard rods										
Reduction factor for hot-dip galvanized rods	$\alpha_{v,h-dg,c1}$	[-]	0,45	0,57	0,56	0,49	0,56	0,61	0,74	0,73
Factor for annular gap	α_{gap}	[-]	0,5							

The anchor shall be used with minimum rupture elongation after fracture $A_5 \geq 9\%$.

MO-VH, MO-VHW, MO-VHS

Performances

Hammer drilling, Dustless drilling
Seismic performance category C1 – threaded rod

Annex C 15

Table C20: Seismic performance category C1 rebar - Hammer drilling, Dustless drilling

Size		Ø8	Ø10	Ø12	Ø16	Ø20	Ø25	Ø32	
Tension load									
Steel failure									
Characteristic resistance rebar BSt 500 S	$N_{Rk,s,C1}$	[kN]	28	43	62	111	173	270	442
Partial safety factor	γ_{Ms}	[-]	1,4						
Characteristic resistance to pull-out for a working life of 50 years									
Dry, wet concrete and flooded hole	$\tau_{Rk,C1}$	[N/mm ²]	5,2	4,3	3,9	2,9	2,5	2,6	2,1
Characteristic resistance to pull-out for a working life of 100 years									
Dry, wet concrete and flooded hole	$\tau_{Rk,C1}$	[N/mm ²]	3,1	2,5	2,5	1,8	1,6	1,6	1,4
Installation safety factor – Dry and wet concrete	γ_{inst}	[-]	1,2						
Installation safety factor – Flooded hole	γ_{inst}	[-]	1,4						
Shear load									
Steel failure without lever arm									
Characteristic resistance rebar BSt 500 S	$V_{Rk,s,C1}$	[kN]	9	12	17	27	43	86	114
Partial safety factor	γ_{Ms}	[-]	1,5						
Factor for annular gap	α_{gap}	[-]	0,5						

The anchor shall be used with minimum rupture elongation after fracture $A_5 \geq 9\%$.

MO-VH, MO-VHW, MO-VHS

Performances
 Hammer drilling, Dustless drilling
 Seismic performance category C1 – rebar

Annex C 16

Table C21: Seismic performance category C2 of threaded rod - Hammer drilling, Dustless drilling

Size			M12	M16	M20
Tension load					
Steel failure					
Characteristic resistance grade 4.6	$N_{Rk,s,C2}$	[kN]	34	63	98
Partial safety factor	γ_{Ms}	[-]	2,00		
Characteristic resistance grade 5.8	$N_{Rk,s,C2}$	[kN]	42	79	123
Partial safety factor	γ_{Ms}	[-]	1,50		
Characteristic resistance grade 8.8	$N_{Rk,s,C2}$	[kN]	67	126	196
Partial safety factor	γ_{Ms}	[-]	1,50		
Characteristic resistance grade 10.9	$N_{Rk,s,C2}$	[kN]	84	157	245
Partial safety factor	γ_{Ms}	[-]	1,33		
Characteristic resistance A2-70, A4-70	$N_{Rk,s,C2}$	[kN]	59	110	172
Partial safety factor	γ_{Ms}	[-]	1,87		
Characteristic resistance A4-80	$N_{Rk,s,C2}$	[kN]	67	126	196
Partial safety factor	γ_{Ms}	[-]	1,60		
Characteristic resistance 1.4529	$N_{Rk,s,C2}$	[kN]	59	110	172
Partial safety factor	γ_{Ms}	[-]	1,50		
Characteristic resistance 1.4565	$N_{Rk,s,C2}$	[kN]	59	110	172
Partial safety factor	γ_{Ms}	[-]	1,87		
Characteristic resistance to pull-out for a working life of 50 years					
Dry, wet concrete and flooded hole	$\tau_{Rk,C2}$	[N/mm ²]	1,2	1,4	1,6
Characteristic resistance to pull-out for a working life of 100 years					
Dry, wet concrete and flooded hole	$\tau_{Rk,C2}$	[N/mm ²]	0,8	1,0	1,0
Installation safety factor – Dry and wet concrete	γ_{inst}	[-]	1,2		
Installation safety factor – Flooded hole	γ_{inst}	[-]	1,4		
Shear load					
Steel failure without lever arm					
Characteristic resistance grade 4.6	$V_{Rk,s,C2}$	[kN]	13	18	28
Partial safety factor	γ_{Ms}	[-]	1,67		
Characteristic resistance grade 5.8	$V_{Rk,s,C2}$	[kN]	16	22	35
Partial safety factor	γ_{Ms}	[-]	1,25		
Characteristic resistance grade 8.8	$V_{Rk,s,C2}$	[kN]	25	36	56
Partial safety factor	γ_{Ms}	[-]	1,25		
Characteristic resistance grade 10.9	$V_{Rk,s,C2}$	[kN]	32	45	70
Partial safety factor	γ_{Ms}	[-]	1,50		
Characteristic resistance A2-70, A4-70	$V_{Rk,s,C2}$	[kN]	22	31	49
Partial safety factor	γ_{Ms}	[-]	1,56		
Characteristic resistance A4-80	$V_{Rk,s,C2}$	[kN]	25	36	56
Partial safety factor	γ_{Ms}	[-]	1,33		
Characteristic resistance 1.4529	$V_{Rk,s,C2}$	[kN]	22	31	49
Partial safety factor	γ_{Ms}	[-]	1,25		
Characteristic resistance 1.4565	$V_{Rk,s,C2}$	[kN]	22	31	49
Partial safety factor	γ_{Ms}	[-]	1,56		
Characteristic shear load resistance $V_{Rk,s,eq}$ in the Table C 21 shall be multiplied by following reduction factor for hot-dip galvanized commercial standard rods					
Reduction factor for hot-dip galvanized rods	$\alpha_{v,h-dg,c2}$	[-]	0,46	0,61	0,61
Factor for annular gap	α_{gap}	[-]	0,5		

Table C22: Displacement under tensile and shear load - seismic category C2

Size		M12	M16	M20
$\delta_{N,C2(50\%)}$	[mm]	0,57	0,35	0,85
$\delta_{N,C2(100\%)}$	[mm]	7,62	6,75	7,28
$\delta_{V,C2(50\%)}$	[mm]	5,29	4,12	4,94
$\delta_{V,C2(100\%)}$	[mm]	10,20	9,05	10,99

The anchor shall be used with minimum rupture elongation after fracture $A_5 \geq 9\%$.

Note: Rebars are not qualified for seismic category C2 design

MO-VH, MO-VHW, MO-VHS

Performances

Hammer drilling, Dustless drilling
Seismic performance category C2 – threaded rod

Annex C 17

Table C23: Seismic performance category C1 of threaded rod for
MO-VHW with installation temperature < -10°C - Hammer drilling, Dustless drilling

Size	M8	M10	M12	M16	M20	M24	M27	M30	
Tension load									
Steel failure									
See Annex C 15									
Characteristic resistance to pull-out for a working life of 50 years									
Dry, wet concrete and flooded hole	$\tau_{RK,C1}$ [N/mm ²]	4,3	5,3	5,5	5,5	4,0	4,9	2,2	1,7
Characteristic resistance to pull-out for a working life of 100 years									
Dry, wet concrete and flooded hole	$\tau_{RK,C1}$ [N/mm ²]	2,8	3,7	3,7	3,9	2,4	3,7	1,5	1,2
Installation safety factor	γ_{inst} [-]	See Annex C15							
Shear load									
Steel failure without lever arm									
See Annex C 15									
Factor for annular gap	α_{gap} [-]	0,5							

The anchor shall be used with minimum rupture elongation after fracture $A_5 \geq 9\%$.

Table C24: Seismic performance category C1 of rebar for
MO-VHW with installation temperature < -10°C - Hammer drilling, Dustless drilling

Size	Ø8	Ø10	Ø12	Ø16	Ø20	Ø25	Ø32	
Tension load								
Steel failure								
See Annex C 16								
Characteristic resistance to pull-out for a working life of 50 years								
Dry, wet concrete and flooded hole	$\tau_{RK,C1}$ [N/mm ²]	5,0	4,1	3,7	2,8	2,4	2,4	2,0
Characteristic resistance to pull-out for a working life of 100 years								
Dry, wet concrete and flooded hole	$\tau_{RK,C1}$ [N/mm ²]	2,9	2,3	2,3	1,8	1,5	1,6	1,3
Installation safety factor	γ_{inst} [-]	See Annex C16						
Shear load								
Steel failure without lever arm								
See Annex C 16								
Factor for annular gap	α_{gap} [-]	0,5						

The anchor shall be used with minimum rupture elongation after fracture $A_5 \geq 9\%$.

Table C25: Seismic performance category C2 of threaded rod for
MO-VHW with installation temperature < -10°C - Hammer drilling, Dustless drilling

Size	M12	M16	M20	
Tension load				
Steel failure				
See Annex C 17				
Characteristic resistance to pull-out for a working life of 50 years				
Dry, wet concrete and flooded hole	$\tau_{RK,C2}$ [N/mm ²]	1,1	1,3	1,5
Characteristic resistance to pull-out for a working life of 100 years				
Dry, wet concrete and flooded hole	$\tau_{RK,C2}$ [N/mm ²]	0,7	0,9	0,9
Installation safety factor	γ_{inst} [-]	See Annex C 17		
Shear load				
Steel failure without lever arm				
See Annex C 17				
Factor for annular gap	α_{gap} [-]	0,5		

MO-VHW

Performances

Hammer drilling, Dustless drilling
Seismic performance category C2

Annex C 18

Characteristic resistance to combined pull-out and concrete failure $\tau_{Rk,fi}(\theta)$ under fire exposure for threaded rods for hammer or dustless drilling

The characteristic resistance to combined pull-out and concrete failure under fire $\tau_{Rk,fi,p}(\theta)$ shall be determined according to following equation:

$$\tau_{Rk,fi,p}(\theta) = k_{fi,p}(\theta) \cdot \tau_{Rk,cr}$$

where:

$$\begin{aligned}
 k_{fi,p}(\theta) &= 1 && \text{for } \theta < \theta_k \\
 k_{fi,p}(\theta) &= 60,79 \cdot \theta^{-1,351} \leq 1 && \text{for } \theta \leq \theta_{max} \\
 k_{fi,p}(\theta) &= 0 && \text{for } \theta > \theta_{max}
 \end{aligned}$$

$$\begin{aligned}
 \theta_k &= 21^\circ\text{C} \\
 \theta_{max} &= 406^\circ\text{C}
 \end{aligned}$$

- $\tau_{Rk,fi,p}$ = characteristic bond resistance for cracked concrete under fire exposure for given temperature (θ)
- $\tau_{Rk,cr}$ = characteristic bond resistance for cracked concrete for concrete strength class C20/25
- $k_{fi,p}(\theta)$ = reduction factor for bond resistance under fire conditions

Figure C1: Reduction factor $k_{fi,p}(\theta)$

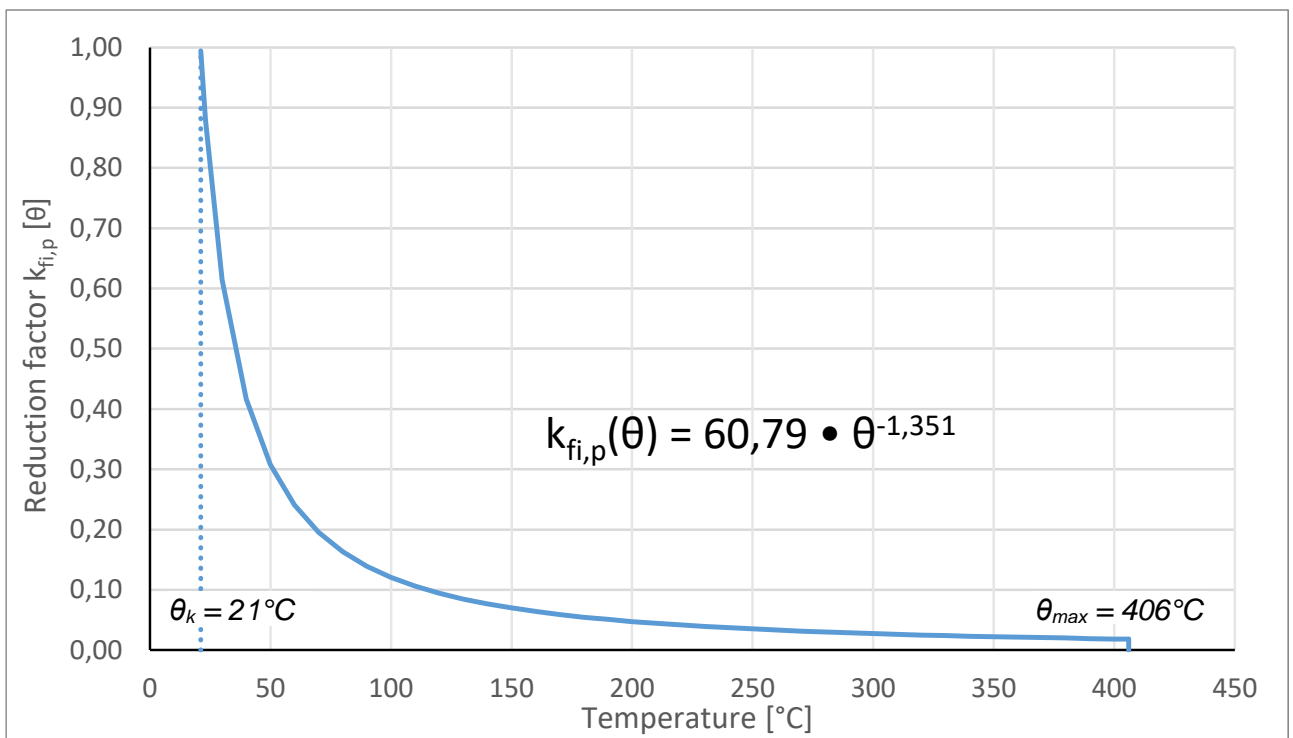

MO-VH, MO-VHW, MO-VHS

Performances
Bond resistance under fire conditions

Annex C 19

Table C26: Steel failure - Characteristic resistance under tension load under fire conditions for threaded rod

Size			M8	M10	M12	M16	M20	M24	M27	M30
Steel grade: 4.6; 5.8; 8.8; 10.9	N _{Rk,s,fi(30)}	[kN]	0,37	0,87	1,69	3,14	4,90	7,06	9,18	11,22
	N _{Rk,s,fi(60)}	[kN]	0,33	0,75	1,26	2,36	3,68	5,30	6,89	8,42
	N _{Rk,s,fi(90)}	[kN]	0,26	0,58	1,10	2,04	3,19	4,59	5,97	7,29
	N _{Rk,s,fi(120)}	[kN]	0,18	0,46	0,84	1,57	2,45	3,53	4,59	5,61
Stainless steel grade: A2-70; A4-70; A4-80	N _{Rk,s,fi(30)}	[kN]	0,73	1,45	2,53	4,71	7,35	10,59	13,77	16,83
	N _{Rk,s,fi(60)}	[kN]	0,59	1,16	2,11	3,93	6,13	8,83	11,48	14,03
High corrosion resistant steel grade: 1.4529; 1.4565	N _{Rk,s,fi(90)}	[kN]	0,44	0,93	1,69	3,14	4,90	7,06	9,18	11,22
	N _{Rk,s,fi(120)}	[kN]	0,37	0,81	1,35	2,51	3,92	5,65	7,34	8,98

Table C27: Steel failure - Characteristic resistance under tension load under fire conditions for rebar

Size			Ø8	Ø10	Ø12	Ø16	Ø20	Ø25	Ø32
Rebar BSt 500 S	N _{Rk,s,fi(30)}	[kN]	0,50	1,18	2,26	4,02	6,28	9,82	16,08
	N _{Rk,s,fi(60)}	[kN]	0,45	1,02	1,70	3,02	4,71	7,36	12,06
	N _{Rk,s,fi(90)}	[kN]	0,35	0,79	1,47	2,61	4,08	6,38	10,45
	N _{Rk,s,fi(120)}	[kN]	0,25	0,63	1,13	2,01	3,14	4,91	8,04

Table C28: Steel failure - Characteristic resistance under shear load under fire conditions for threaded rod

Size			M8	M10	M12	M16	M20	M24	M27	M30
Steel grade: 4.6; 5.8; 8.8; 10.9	V _{Rk,s,fi(30)}	[kN]	0,37	0,87	1,69	3,14	4,90	7,06	9,18	11,22
	V _{Rk,s,fi(60)}	[kN]	0,33	0,75	1,26	2,36	3,68	5,30	6,89	8,42
	V _{Rk,s,fi(90)}	[kN]	0,26	0,58	1,10	2,04	3,19	4,59	5,97	7,29
	V _{Rk,s,fi(120)}	[kN]	0,18	0,46	0,84	1,57	2,45	3,53	4,59	5,61
	M ⁰ _{Rk,s,fi(30)}	[N.m]	0,4	1,1	2,6	6,7	13,0	22,5	33,3	45,0
	M ⁰ _{Rk,s,fi(60)}	[N.m]	0,3	1,0	2,0	5,0	9,7	16,8	25,0	33,7
	M ⁰ _{Rk,s,fi(90)}	[N.m]	0,3	0,7	1,7	4,3	8,4	14,6	21,6	29,2
	M ⁰ _{Rk,s,fi(120)}	[N.m]	0,2	0,6	1,3	3,3	6,5	11,2	16,6	22,5
Stainless steel grade: A2-70; A4-70; A4-80	V _{Rk,s,fi(30)}	[kN]	0,73	1,45	2,53	4,71	7,35	10,59	13,77	16,83
	V _{Rk,s,fi(60)}	[kN]	0,59	1,16	2,11	3,93	6,13	8,83	11,48	14,03
High corrosion resistant steel grade: 1.4529; 1.4565	V _{Rk,s,fi(90)}	[kN]	0,44	0,93	1,69	3,14	4,90	7,06	9,18	11,22
	V _{Rk,s,fi(120)}	[kN]	0,37	0,81	1,35	2,51	3,92	5,65	7,34	8,98
	M ⁰ _{Rk,s,fi(30)}	[N.m]	0,7	1,9	3,9	10,0	19,5	33,7	49,9	67,5
	M ⁰ _{Rk,s,fi(60)}	[N.m]	0,6	1,5	3,3	8,3	16,2	28,1	41,6	56,2
	M ⁰ _{Rk,s,fi(90)}	[N.m]	0,4	1,2	2,6	6,7	13,0	22,5	33,3	45,0
	M ⁰ _{Rk,s,fi(120)}	[N.m]	0,4	1,0	2,1	5,3	10,4	18,0	26,6	36,0

Table C29: Steel failure - Characteristic resistance under shear load under fire conditions for rebar

Size			Ø8	Ø10	Ø12	Ø16	Ø20	Ø25	Ø32
Rebar BSt 500 S	V _{Rk,s,fi(30)}	[kN]	0,50	1,18	2,26	4,02	6,28	9,82	16,08
	V _{Rk,s,fi(60)}	[kN]	0,45	1,02	1,70	3,02	4,71	7,36	12,06
	V _{Rk,s,fi(90)}	[kN]	0,35	0,79	1,47	2,61	4,08	6,38	10,45
	V _{Rk,s,fi(120)}	[kN]	0,25	0,63	1,13	2,01	3,14	4,91	8,04
	M ⁰ _{Rk,s,fi(30)}	[N.m]	0,6	1,8	4,1	9,7	18,9	36,8	77,2
	M ⁰ _{Rk,s,fi(60)}	[N.m]	0,5	1,5	3,1	7,2	14,1	27,6	57,9
	M ⁰ _{Rk,s,fi(90)}	[N.m]	0,4	1,2	2,6	6,3	12,3	23,9	50,2
	M ⁰ _{Rk,s,fi(120)}	[N.m]	0,3	0,9	2,0	4,8	9,4	18,4	38,6

MO-VH, MO-VHW, MO-VHS

Performances
Bond resistance under fire conditions

Annex C 20