

MO-PSU



CERTIFICATES



BASE MATERIAL



CHARACTERISTICS

- Assessed for structural applications in non-cracked concrete M8-M16.
- Assessed for use in masonry
- LEED and A+ certificates, Styrene free.
- Use for medium-high loads, static or quasi-static.
- Valid for dry, wet and flooded holes.
- Valid for zinc plated steel, hot-dip galvanized, stainless steel A2, A4 and HCR.
- Service temperature range: from -40°C to +80°C (long term maximum temperature +50°C).

VALID FOR



APPLICATIONS

- Use in indoor and outdoor environments.
- Structural applications.
- Fixing of building substructures.
- Rehabilitation of facades.
- For fixing air conditioning supports, boilers, awnings, garage door frames, signs, balconies, shelving units, railings, handrails, etc.

DRILL HOLE CONDITION

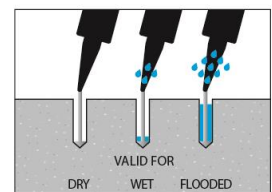

APPLICATION EXAMPLES



MAXIMUM LOAD RECOMMENDED [kg]









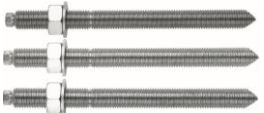

TECHNICAL DATASHEET

1. RANGE



ITEM	CODE	SIZE	PHOTO	COMPONENT	MATERIAL	
1	MOPSU300 MOPSU410	300 ml. 410 ml.		STYRENE FREE POLYESTER UNIVERSAL MORTAR	Styrene free polyester universal. Format: 300 and 410 ml cartridges	12

2. ACCESSORIES

ITEM	CODE	PHOTO	COMPONENT	MATERIAL
1	MOPISSI		APPLICATION GUNS	Gun for 300 ml standard cartridges
	MOPISTO			Gun for 410 ml coaxial cartridges
2	EQ-AC EQ-8.8 EQ-A2 EQ-A4		STUD BOLTS	Threaded steel stud, class 5.8 ISO 898-1 Threaded steel stud, class 8.8 ISO 898-1 Threaded stainless steel stud A2-70 Threaded stainless steel stud A4-70
3	MORCEPKIT		CLEANING BRUSHES	3 Cleaning brushes kit of $\varnothing 14$, $\varnothing 20$ and $\varnothing 29$ mm.
4	MOBOMBA		CLEANING PUMP	Pump for cleaning dust and drill hole fragments
5	MORCANU		MIXING NOZZLE	Plastic. Helix static mixer.
6	MO-TN		NYLON SLEEVE	Plastic. Available in white and grey
7	MO-TR		METAL THREADED SLEEVE	Metal threaded sleeve M8, M10, M12, zinc plated.
8	MO-TM		METAL SLEEVE	Metal sleeve of $\varnothing 12$, $\varnothing 16$ and $\varnothing 22$,

3. INSTALLATION DATA

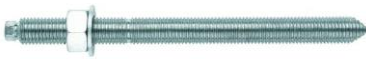
3.1. CONCRETE FIXING (SET UP PARAMETERS)

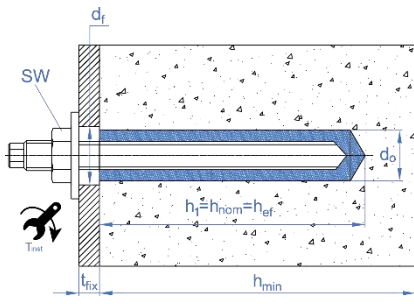
SIZE		M8	M10	M12	M16
d_0 : nominal diameter	[mm]	10	12	14	18
d_f : fixture hole diameter \leq	[mm]	9	12	14	18
T_{ins} : torque \leq	[Nm]	10	20	40	80
Circular cleaning brush diameter		$\varnothing 14$		$\varnothing 20$	
$h_{ef,min}$					
h_1 : drill hole depth	[mm]	64	80	96	128
$s_{cr,N}$: critical spacing	[mm]	192	240	288	384
$c_{cr,N}$: critical edge distance	[mm]	96	120	144	192
c_{min} : minimum distance to edge	[mm]	35	40	50	70
s_{min} : minimum spacing	[mm]	40	40	50	70
h_{min} : minimum concrete thickness	[mm]	100	110	126	158
Standard stud					
h_1 : drill hole depth	[mm]	80	90	110	128
$s_{cr,N}$: critical spacing	[mm]	240	270	330	384
$c_{cr,N}$: critical edge distance	[mm]	120	135	165	192
c_{min} : minimum distance to edge	[mm]	35	40	50	70
s_{min} : minimum spacing	[mm]	40	40	50	70
h_{min} : minimum concrete thickness	[mm]	110	120	140	158
$h_{ef,max}$					
h_1 : drill hole depth	[mm]	96	120	144	192
$s_{cr,N}$: critical spacing	[mm]	288	360	432	576
$c_{cr,N}$: critical edge distance	[mm]	144	180	216	288
c_{min} : minimum distance to edge	[mm]	35	40	50	70
s_{min} : minimum spacing	[mm]	40	40	50	70
h_{min} : minimum concrete thickness	[mm]	126	150	174	222
<p>5.8 / 8.8 Zinc plated stud code</p> 		EQAC08110 EQ8808110	EQAC10130 EQ8810130	EQAC12160 EQ8812160	EQAC16190 EQ8816190
<p>A2 / A4 Stainless steel stud code</p> 		EQA208110 EQA408110	EQA210130 EQA410130	EQA212160 EQA412160	EQA216190 EQA416190
		<ul style="list-style-type: none"> h_{ef} depth value may be selected by the user ranging between $h_{ef,min} = 8d$ and $h_{ef,max} = 12d$. Any intermediate values may be interpolated. Critical distances are those where anchors in a group of anchors are not influenced by one another with regard to tension load effects. For smaller distances, down to minimum distances, corresponding reduction coefficients must be applied. Standard studs are available for each measurement, as shown in the table. 			

3.2. FIXING IN SOLID OR HOLLOW MASONRY (SET UP PARAMETERS)

BASE MATERIAL		BRICK N°1				BRICK N°2				BRICK N°3			
TYPE OF FIXING		With sleeve				With sleeve				Without sleeve			
SIZE		M6	M8	M10	M12	M6	M8	M10	M12	M6	M8	M10	M12
l_s : Plastic sleeve length	[mm]	80	85	85	85	80	80	85	85	--	--	--	--
d_0 : Plastic sleeve diameter	[mm]	12	16	16	16	12	12	16	16	--	--	--	--
v : Mortar volume per sleeve	[ml]	8	8	15	27	8	8	15	27	8	15	15	27
d_0 : Drill bit diameter	[mm]	12	16	16	16	12	12	16	16	8	10	12	14
h_1 : Drill hole depth \geq	[mm]	85	90	90	90	85	85	90	90	80	90	90	90
h_{ef} : stud bolt depth \geq	[mm]	80	85	85	85	80	80	85	85	80	90	90	90
h_{nom} : sleeve installation depth	[mm]	85	85	85	85	80	80	85	85	--	--	--	--
d_f : metal sheet diameter \leq	[mm]	7	9	12	14	9	9	12	14	7	9	12	14
T_{ins} : torque \leq	[Nm]	2	2	2	2	2	2	2	2	2	2	2	2
d_b : Circular brush	[mm]	14	14	20	20	14	14	20	20	9	14	14	14
Sleeve code	[--]	MOTN12080		MOTN15085	MOTN20080	MOTN12080	MOTN12080	MOTN15085	MOTN20080	--	--	--	--

SIZE		M6/M8 Sleeve $\varnothing 12$			M8/M10/M12 Sleeve $\varnothing 16$			M6			M8/M10/M12		
Minimum spacing and edge distances		$C_{cr} = C_{min}$	$S_{cr II} = S_{min II}$	$S_{cr \perp} = S_{min \perp}$	$C_{cr} = C_{min}$	$S_{cr II} = S_{min II}$	$S_{cr \perp} = S_{min \perp}$	$C_{cr} = C_{min}$	$S_{cr II} = S_{min II}$	$S_{cr \perp} = S_{min \perp}$	$C_{cr} = C_{min}$	$S_{cr II} = S_{min II}$	$S_{cr \perp} = S_{min \perp}$
Brick number 1	[mm]	100	245	110	--	--	--	--	--	--	--	--	--
Brick number 2	[mm]	--	--	--	100	373	238	--	--	--	--	--	--
Brick number 3	[mm]	--	--	--	--	--	--	100	245	110	135	270	270

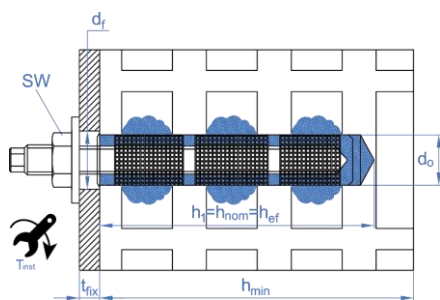

In order to make fixations in hollow bricks a nylon sleeve should be used to prevent the resin from falling through the inner holes.

BRICK TYPES



Brick nº 1
Hollow clay brick PERFORADO 10 according to EN 771-1
 length/width/height: 245 mm / 110 mm / 100 mm
 $fb \geq 15 \text{ N/mm}^2 / \rho \geq 2,05 \text{ kg/dm}^3$

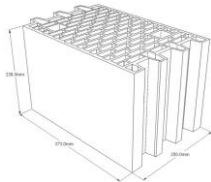

Brick nº 2
Hollow clay brick Porotherm 25 P+W KL 15 according to EN 771-1
 length/width/height: 373 mm / 250 mm / 238 mm
 $fb \geq 12 \text{ N/mm}^2 / \rho \geq 0,9 \text{ kg/dm}^3$

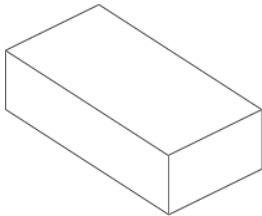

Brick nº 3
Solid baked clay brick Mz 12-2, 0-NF according to EN 771-1. Length / width / height:
 240 mm / 115 mm / 71 mm
 $fb \geq 20 \text{ N/mm}^2 / \rho \geq 1,09 \text{ kg/dm}^3$

4. PRODUCT SET UP

4.1. CONCRETE SET UP

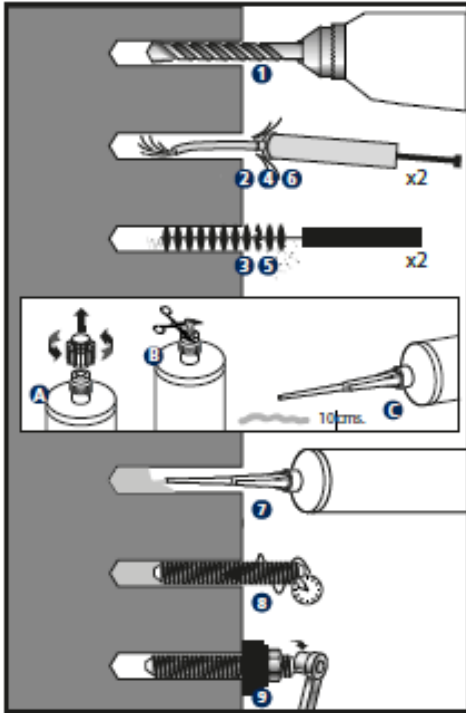

1. DRILL

Check the concrete base is compact and porosity is insignificant.
 Suitable for wet, dry or flooded drill holes.
 Cartridge installation temperature: $\geq 5\text{ }^{\circ}\text{C}$.
 Base material installation temperature: MO-PSU $\geq -5\text{ }^{\circ}\text{C}$
 Use drill in hammer mode.
 Drill to the specified diameter and depth values

2 - 6. BLOW AND CLEAN

Clear the drill holes completely of dust and fragments by following the procedure shown in the picture. If the drill hole is flooded, the water must be removed before mortar is injected.

A - B* - C. OPEN CARTRIDGE

Screw the nozzle into the cartridge and place the assembly in the application gun. Squeeze on the trigger repeatedly until the mortar comes out of the nozzle in a uniform blue color. Any iridescence indicates improper mixing. Always discard the first two doses of each cartridge: these are never to be used for fixing. *For 300 ml cartridges, cut end of bag, behind seal clip.

7. INJECT MORTAR

Insert the nozzle to the bottom of the drill hole and apply mortar: gradually remove the nozzle, ensuring there are no air bubbles. Fill the hole to $\frac{1}{2}$ and $\frac{3}{4}$ of its depth.
 In the event of not fully using the cartridge, leave nozzle attached. Only change if using again and handling time has expired, remembering to discard the first two doses of mortar.

8. INSTALLATION

Introduce the stud to be installed by screwing it lightly down to the installation depth value manually; ensuring the mortar covers the stud thread. The introduction of the anchor must take place within the handling time. The mortar must seep from the top of the drill hole to ensure it is completely full and there are no gaps between the stud and the drill hole. While the MO-PUS is blue, the rod can be adjusted and moved so that it is correctly fitted

TEMPERATURE AND CURING TIME

TYPE	Cartridge temperature [°C]	Handling time [min]	Base material temperature [°C]	Curing time [min]
MO-PSU	Min +5	18	Min +5	160
	+5 a +10	10	+5 a +10	160
	+10 a +20	6	+10 a +20	90
	+20 a +25	5	+20 a +25	60
	+25 a +30	4	+25 a +30	50
	+30	4	+30	40

9. APPLY TORQUE

Once the curing time has elapsed (when the color is completely grey), apply torque, never exceeding the values indicated in the table.

4.2. MASONRY SET UP

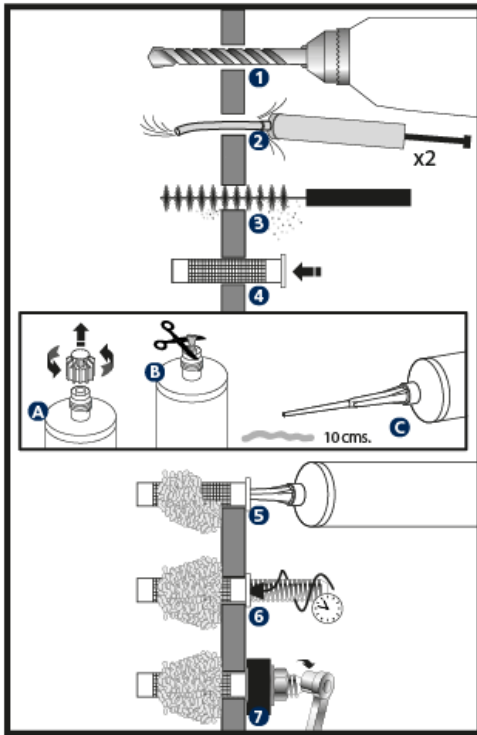

1. DRILL

Check the concrete base is compact and porosity is insignificant.

Suitable for wet, dry or flooded drill holes.

Cartridge installation temperature: $\geq 5\text{ }^{\circ}\text{C}$.

Base material installation temperature: MO-PSU $\geq +5\text{ }^{\circ}\text{C}$

Use drill in rotation mode.

Drill to the specified diameter and depth values

2 - 3. BLOW AND CLEAN

Clear the drill holes completely of dust and fragments by following the procedure shown in the picture. If the drill hole is flooded, the water must be removed before mortar is injected.

4. POSITION SLEEVE(S)

Insert the metal or plastic sleeve into the drill hole so it is level with the surface of the base material.

A – B* – C. OPEN CARTRIDGE

Screw the nozzle into the cartridge and place the assembly in the application gun. Squeeze on the trigger repeatedly until the mortar comes out of the nozzle in a uniform grey color. Any iridescence indicates improper mixing. Always discard the first two doses of each cartridge: these are never to be used for fixing. ***For 300 ml cartridges, cut end of bag, behind seal clip.**

5. INJECT MORTAR

Insert the nozzle to the bottom of the drill hole and apply mortar: gradually remove the nozzle, ensuring there are no air bubbles. Fill the sleeve fully.

In the event of not fully using the cartridge, leave nozzle attached. Only change if using again and handling time has expired, remembering to discard the first two doses of mortar.

6. INSTALLATION

Introduce the stud to be installed by screwing it lightly down to the installation depth value manually; ensuring the mortar covers the stud thread. The introduction of the anchor must take place within the handling time. The mortar must seep from the top of the sleeve hole to ensure it is completely full and there are no gaps between the stud and the drill hole.

TEMPERATURE AND CURING TIME

TYPE	Cartridge temperature [°C]	Handling time [min]	Base material temperature [°C]	Curing time [min]
MO-PSU	Min +5	18	Min +5	160
	+5 a +10	10	+5 a +10	160
	+10 a +20	6	+10 a +20	90
	+20 a +25	5	+20 a +25	60
	+25 a +30	4	+25 a +30	50
	+30	4	+30	40

7. APPLY TORQUE

Once the curing time has elapsed, apply torque, never exceeding the values indicated in the table.

5. STORAGE CONDITIONS

Keep the product stored in a cool, dry place, away from direct sunlight and heat sources, at an average temperature between +5 °C and +25 °C.

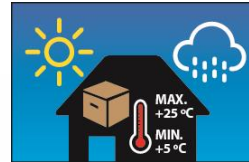

Shelf life of unopened cartridge: 15 months from the date of manufacture. The expiration date is indicated on the cartridge.

6. RESISTANCES

6.1 CONCRETE FIXATION

Characteristic resistances for C20/25 concrete for an isolated anchor (without considering anchor-to-anchor or anchor-to-edge distance effects) and class 5.8 studs or A4-70 stainless steel are shown in tables below.

CHARACTERISTIC RESISTANCES

CONCRETE CLASS	SIZE				M8	M10	M12	M16	
NON-CRACKED CONCRETE	ZINC PLATED	Tension	$h_{ef,min} = 8d$	N_{Rk}	[kN]	9,33	13,57	16,65	26,38
			Standard stud	N_{Rk}	[kN]	11,66	15,27	19,08	26,38
			$h_{ef,max} = 12d$	N_{Rk}	[kN]	13,99	20,36	24,97	39,57
		Shear	All depths 5.8	V_{Rk}	[kN]	<u>9,0</u>	<u>15,0</u>	<u>21,0</u>	<u>39,0</u>
			All depths 8.8	V_{Rk}	[kN]	<u>15,0</u>	<u>23,0</u>	<u>34,0</u>	<u>63,0</u>
		STAINLESS STEEL	Tension	$h_{ef,min} = 8d$	N_{Rk}	[kN]	9,33	13,57	16,65
	Standard stud			N_{Rk}	[kN]	11,66	15,27	19,08	26,38
	$h_{ef,max} = 12d$			N_{Rk}	[kN]	13,99	20,36	24,97	39,57
	Shear		All depths	V_{Rk}	[kN]	<u>13,0</u>	<u>20,0</u>	<u>30,0</u>	<u>55,0</u>

TECHNICAL DATASHEET

DESIGN RESISTANCES

CONCRETE CLASS	SIZE				M8	M10	M12	M16	
	NON-CRACKED CONCRETE	ZINC PLATED	Tension	$h_{ef,min} = 8d$	N_{Rd}	[kN]	5,18	7,54	9,25
Standard stud				N_{Rd}	[kN]	6,48	8,48	10,60	14,66
$h_{ef,max} = 12d$				N_{Rd}	[kN]	7,77	11,31	13,87	21,98
Shear			All depths 5.8	V_{Rd}	[kN]	<u>7,2</u>	<u>12,0</u>	<u>16,8</u>	<u>31,2</u>
			All depths 8.8	V_{Rd}	[kN]	<u>12,0</u>	<u>18,4</u>	<u>27,2</u>	<u>50,4</u>
STAINLESS STEEL		Tension	$h_{ef,min} = 8d$	N_{Rd}	[kN]	5,18	7,54	9,25	14,66
			Standard stud	N_{Rd}	[kN]	6,48	8,48	10,60	14,66
			$h_{ef,max} = 12d$	N_{Rd}	[kN]	7,77	11,31	13,87	21,98
		Shear	All depths	V_{Rd}	[kN]	<u>8,3</u>	<u>12,8</u>	<u>19,2</u>	<u>35,2</u>

MAXIMUM LOADS RECOMMENDED (when $\gamma_f = 1.4$)

CONCRETE CLASS	SIZE				M8	M10	M12	M16	
	NON-CRACKED CONCRETE	ZINC PLATED	Tension	$h_{ef,min} = 8d$	N_{rec}	[kN]	3,70	5,39	6,61
Standard stud				N_{rec}	[kN]	4,63	6,06	7,57	10,47
$h_{ef,max} = 12d$				N_{rec}	[kN]	5,55	8,08	9,91	15,70
Shear			All depths 5.8	V_{rec}	[kN]	<u>5,1</u>	<u>8,5</u>	<u>12,0</u>	<u>22,2</u>
			All depths 8.8	V_{rec}	[kN]	<u>8,5</u>	<u>13,1</u>	<u>19,4</u>	<u>36,0</u>
STAINLESS STEEL		Tension	$h_{ef,min} = 8d$	N_{rec}	[kN]	3,70	5,39	6,61	10,47
			Standard stud	N_{rec}	[kN]	4,63	6,06	7,57	10,47
			$h_{ef,max} = 12d$	N_{rec}	[kN]	5,55	8,08	9,91	15,70
		Shear	All depths	V_{rec}	[kN]	<u>5,9</u>	<u>9,1</u>	<u>13,7</u>	<u>25,1</u>

COEFFICIENTS FOR TENSION LOADS IN PULL-OUT FAILURE IN HIGH-RESISTANCE CONCRETE TYPES

CONCRETE COEFFICIENT	C30/37	C40/50	C50/60
Ψ_c (Non-cracked)	1,04	1,07	1,09

6.2 MASONRY FIXATION

Characteristic resistances in masonry for an isolated anchor (without considering anchor-to-anchor or anchor-to-edge distance effects) and class 5.8 studs or A4-70 stainless steel are shown in tables below.

Use categories in respect of installation and use:

- Category d/d - Installation and use in structures subject to dry, internal conditions
- Category w/d - Installation in dry or wet substrate and use in structures subject to dry, internal conditions
- Category w/w - Installation and use in structures subject to dry or wet environmental conditions

CHARACTERISTIC RESISTANCES (F_{Rk})

ANCHOR TYPE		THREADED ROD WITH OR WITHOUT SLEEVE, TENSION AND SHEAR [kN]									
USE CONDITION		d/d, w/d					w/w				
BASE MATERIAL	SLEEVE	M6	M8	M8	M10	M12	M6	M8	M8	M10	M12
Brick number 1	Ø12 x 80	1,2	1,2	--	--	--	1,2	1,2	--	--	--
Brick number 2	Ø16 x 85	--	--	0,9	1,2	1,2	--	--	0,9	1,2	1,2
Brick number 3	--	1,2	1,2		1,5	2	0,9	0,9		1,5	1,5

DESIGN RESISTANCES (F_{Rd})

ANCHOR TYPE		THREADED ROD WITH OR WITHOUT SLEEVE, TENSION AND SHEAR [kN]									
USE CONDITION		d/d, w/d					w/w				
BASE MATERIAL	SLEEVE	M6	M8	M8	M10	M12	M6	M8	M8	M10	M12
Brick number 1	Ø12 x 80	0,48	0,48	--	--	--	0,48	0,48	--	--	--
Brick number 2	Ø16 x 85	--	--	0,36	0,48	0,48	--	--	0,36	0,48	0,48
Brick number 3	--	0,48	0,48		0,6	0,8	0,36	0,36		0,6	0,6

MAXIMUM LOADS RECOMMENDED (F_{rec}) [with $\gamma_f = 1.4$]

ANCHOR TYPE		THREADED ROD WITH OR WITHOUT SLEEVE, TENSION AND SHEAR [kN]									
USE CONDITION		d/d, w/d					w/w				
BASE MATERIAL	SLEEVE	M6	M8	M8	M10	M12	M6	M8	M8	M10	M12
Brick number 1	Ø12 x 80	0,34	0,34	--	--	--	0,34	0,34	--	--	--
Brick number 2	Ø16 x 85	--	--	0,26	0,34	0,34	--	--	0,26	0,34	0,34
Brick number 3	--	0,34	0,34		0,43	0,57	0,26	0,26		0,43	0,43

7. OFFICIAL DOCUMENTATION

The following documents are available through our Sales department or on our official website: www.indexfix.com:

- MOPSU Safety Data Sheet.
- European Technical Assessment ETA 24/0872 for use on non-cracked concrete according to EAD 330232-01-0601 Guide, option 7, for M8 to M16.
- European Technical Assessment ETA 24/1141 for the use in masonry according to EAD 330076-01-0604 guide
- Classified A+ according to French Regulation DEVL11044875A relative to the emission of volatile pollutants for indoor use.
- LEED MOPSU Sustainability certificate
- Declaration of Performance DoP MOPSU
- INDEXcal anchor calculation software.
- INDEXmor cartridge calculation needs software.