



THE



THT



THA



THP

CARACTÉRISTIQUES

- Un avant-trou est nécessaire ; le filetage du matériau de support s'effectue durant l'installation de l'ancrage.
- Utilisable pour des charges hautes. Haute résistance au feu.
- Apte pour 2 profondeurs d'installation et même 3 avec le Ø10.
- Fixations structurales dans le béton fissuré et non fissuré.
- Se conformer au guide VdS CEA 4001 :2021-01(07) "Guidelines for sprinklers systems. Planning and installation"
- Conçu pour le béton fissuré et non fissuré.
- Utiliser pour les charges statiques ou quasi-statiques.
- Installation facile.
- Installation directe à travers le trou de la plaque d'ancrage.
- Réutilisable
- Peut se démonter, en laissant la superficie diaphane.
- Variété de longueurs et métriques, flexibilité dans l'assemblage
- VdS disponible de Ø6 à Ø18
- Disponible en INDEXcal



GAMME DE MESURES

Ø5 - Ø18

CONDITIONNEMENT DU TROU



SEC

HUMIDE

INONDÉ

**CHARGES MAXIMALES RECOMMANDÉES
A LA TRACTION DANS LE BETON NON-
FISSURE [kg]**

APPLICATION

- Fixations structurales en béton fissuré et non fissuré
- Vitrages, fenêtres et vitrines.
- Étagères et racks
- Installation de balustrades et rampes en intérieurs
- Fixation de structures en bois dans béton

EVALUATIONS





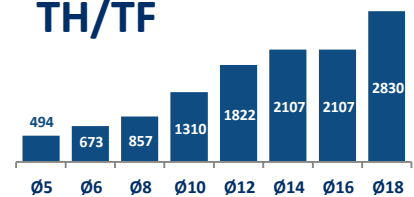



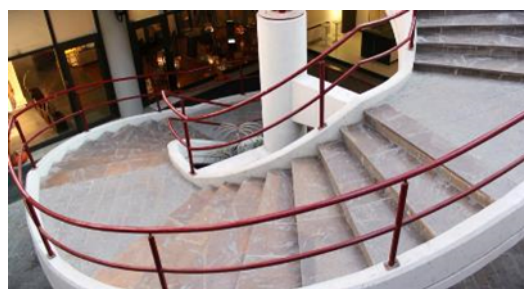

TH/TF



EXEMPLES D'APPLICATION



1. GAMME						
ITEM	CODE	SIZES	PHOTO	DESCRIPTION	MATÉRIAU	COUVRANT
1	THE	Ø5 - Ø18		Tête hexagonale à collerette	Acier au carbone estampé, ATLANTIS revêtement	
2	THA	Ø5 - Ø10		Fraisée, creux hexalobulaire	Acier au carbone estampé, ATLANTIS revêtement	
3	THT	Ø6		Tête bombée, empreinte hexalobulaire	Acier au carbone estampé, ATLANTIS revêtement	
4	THP	Ø5 - Ø8		Tête ronde, empreinte hexalobulaire	Acier au carbone estampé, ATLANTIS revêtement	

2. DONNÉES D'INSTALLATION

2.1. PLAN D'INSTALLATION

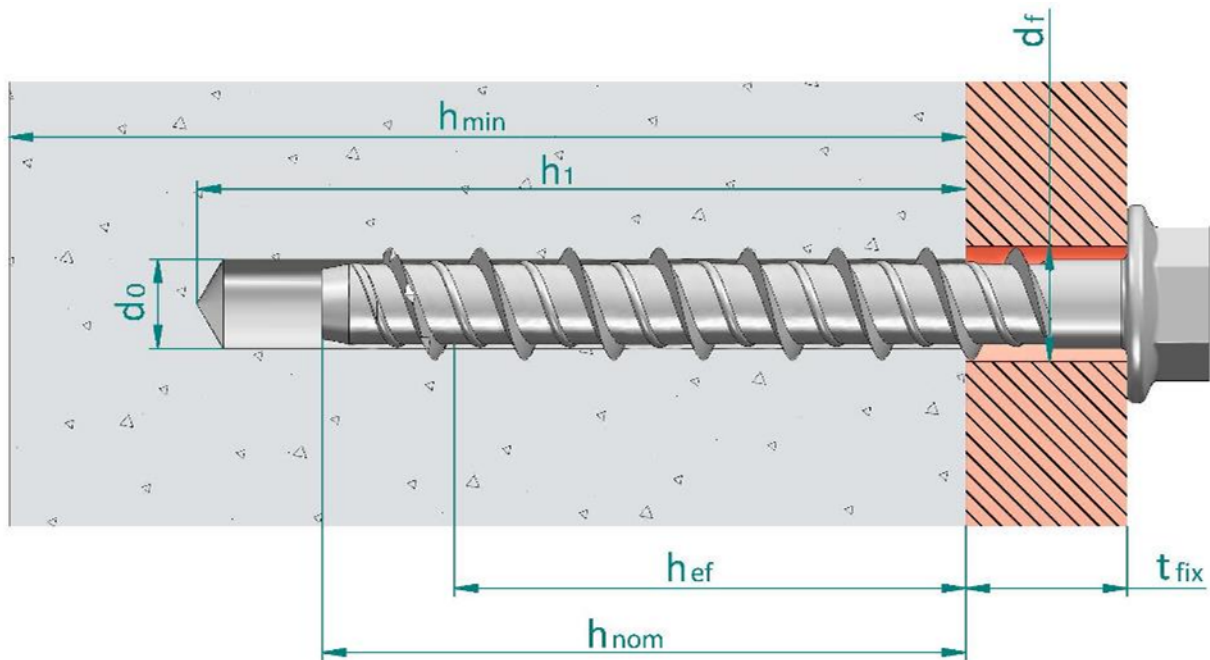

- d_0 : Diamètre du foret
- d_b : Épaisseur du fond de la dalle
- d_f : Diamètre du trou d'épaisseur à fixer
- h_{ef} : Profondeur effective
- h_1 : Profondeur du trou foré
- h_{nom} : Profondeur d'installation
- h_{min} : Epaisseur minimale du béton
- t_{fix} : Épaisseur à fixer

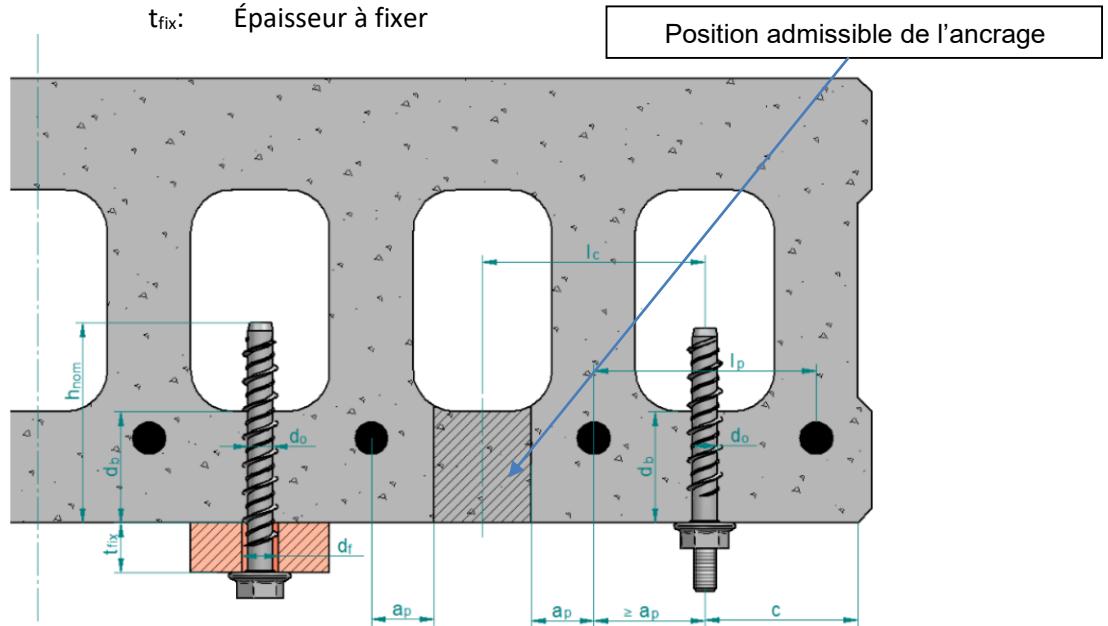

2.2. ÉVALUATION DE CHARGES SISMIQUES

Famille	Code	Dimension (Lettre)	Evaluation	C1	C2	Famille	Code	Dimension (Lettre)	Evaluation	C1	C2
[--]	[--]	[--]	ETA	[--]	[--]	[--]	[--]	[--]	ETA	[--]	[--]
THE	THE05040	Ø5 x 40 (A)	✓*	--	--	THE	THE16100	Ø16 x 100	✓	--	--
	THE05050	Ø5 x 50 (A)	✓*	--	--		THE16150	Ø16 x 150	✓	--	--
	THE05060	Ø5 x 60 (B)	✓*	--	--		THE18100	Ø18 x 100	✓	--	--
	THE05080	Ø5 x 80 (D)	✓*	--	--		THE18130	Ø18 x 130	✓	--	--
	THE05100	Ø5 x 100 (E)	✓*	--	--		THE18160	Ø18 x 160	✓	✓	✓
	THE06035	Ø6 x 35	✓	--	--		THE18180	Ø18 x 180	✓	✓	✓
	THE06040	Ø6 x 40	✓	--	--		THE18200	Ø18 x 200	✓	✓	✓
	THE06045	Ø6 x 45	✓	--	--		THA05040	Ø5 x 40 (A)	✓*	--	--
	THE06050	Ø6 x 50	✓	--	--		THA05060	Ø5 x 60 (B)	✓*	--	--
	THE06060	Ø6 x 60	✓	✓	--		THA05080	Ø5 x 80 (D)	✓*	--	--
	THE06070	Ø6 x 70	✓	✓	--	THA05100	Ø5 x 100 (E)	✓*	--	--	
	THE06080	Ø6 x 80	✓	✓	--	THA06045	Ø6 x 45	✓	--	--	
	THE06100	Ø6 x 100	✓	✓	--	THA06050	Ø6 x 50	✓	--	--	
	THE06120	Ø6 x 120	✓	✓	--	THA06060	Ø6 x 60	✓	✓	--	
	THE08055	Ø8 x 55	✓	✓	✓	THA06080	Ø6 x 80	✓	✓	--	
	THE08060	Ø8 x 60	✓	✓	✓	THA06100	Ø6 x 100	✓	✓	--	
	THE08070	Ø8 x 70	✓	✓	✓	THA06120	Ø6 x 120	✓	✓	--	
	THE08075	Ø8 x 75	✓	✓	✓	THA06140	Ø6 x 140	✓	✓	--	
	THE08080	Ø8 x 80	✓	✓	✓	THA08060	Ø8 x 60	✓	✓	✓	
	THE08090	Ø8 x 90	✓	✓	✓	THA08080	Ø8 x 80	✓	✓	✓	
	THE08100	Ø8 x 100	✓	✓	✓	THA08100	Ø8 x 100	✓	✓	✓	
	THE08110	Ø8 x 110	✓	✓	✓	THA08120	Ø8 x 120	✓	✓	✓	
	THE08120	Ø8 x 120	✓	✓	✓	THA10100	Ø10 x 100	✓	✓	✓	
	THE08140	Ø8 x 140	✓	✓	✓	THA10120	Ø10 x 120	✓	✓	✓	
	THE10060	Ø10 x 60	✓	--	--	THT06040	Ø6 x 40	✓	--	--	
	THE10070	Ø10 x 70	✓	--	--	THT06050	Ø6 x 50	✓	--	--	
	THE10080	Ø10 x 80	✓	--	--	THT06060	Ø6 x 60	✓	✓	--	
	THE10090	Ø10 x 90	✓	✓	✓	THP05040	Ø5 x 40 (A)	✓*	--	--	
	THE10100	Ø10 x 100	✓	✓	✓	THP05060	Ø5 x 60 (B)	✓*	--	--	
	THE10120	Ø10 x 120	✓	✓	✓	THP06040	Ø6 x 40	✓	--	--	
	THE10140	Ø10 x 140	✓	✓	✓	THP06050	Ø6 x 50	✓	--	--	
	THE10160	Ø10 x 160	✓	✓	✓	THP06060	Ø6 x 60	✓	✓	--	
	THE10180	Ø10 x 180	✓	✓	✓	THP06080	Ø6 x 80	✓	✓	--	
	THE12080	Ø12 x 80	✓	--	--	THP06100	Ø6 x 100	✓	✓	--	
	THE12090	Ø12 x 90	✓	--	--	THP08060	Ø8 x 60	✓	✓	✓	
	THE12100	Ø12 x 100	✓	--	--	THP08080	Ø8 x 80	✓	✓	✓	
	THE12110	Ø12 x 110	✓	✓	✓						
	THE12130	Ø12 x 130	✓	✓	✓						
	THE12150	Ø12 x 150	✓	✓	✓						
	THE14080	Ø14 x 80	✓	--	--						
THE14100	Ø14 x 100	✓	--	--							
THE14110	Ø14 x 110	✓	--	--							
THE14120	Ø14 x 120	✓	✓	✓							
THE14130	Ø14 x 130	✓	✓	✓							
THE14140	Ø14 x 140	✓	✓	✓							
THE14160	Ø14 x 160	✓	✓	✓							

3. PARAMETRES D'INSTALLATION (BÉTON)

Paramètres généraux d'installation				Profondeur d'installation standard ($h_{ef, std}$)												Profondeur d'installation réduite ($h_{ef, red}$)												
Famille	Code	Dimension (Lettre)	Evaluation	Diamètre du foret	Diamètre du trou d'épaisseur à fixer	Version du tête	Couple de serrage maximal	Distance minimale entre axes	Distance minimale au bord	Épaisseur minimale du béton	Profondeur du trou foré	Profondeur d'installation	Profondeur effective	Épaisseur à fixer	Distance minimale entre axes (cône)	Distance critique au bord (cône)	Distance minimale entre axes (fissuration)	Distance critique au bord (fissuration)	Épaisseur minimale du béton	Profondeur du trou foré	Profondeur d'installation	Profondeur effective	Épaisseur à fixer	Distance minimale entre axes (cône)	Distance critique au bord (cône)	Distance minimale entre axes (fissuration)	Distance critique au bord (fissuration)	
[--]	[--]	[--]	ETA	d_0 [mm]	d_f [mm]	SW/Tx [--]	T_{inst} [Nm]	S_{min} [mm]	C_{min} [mm]	h_{min} [mm]	h_1 [mm]	h_{nom} [mm]	h_{ef} [mm]	t_{fix} [mm]	$S_{cr,N}$ [mm]	$C_{cr,N}$ [mm]	$S_{cr,sp}$ [mm]	$C_{cr,sp}$ [mm]	h_{min} [mm]	h_1 [mm]	h_{nom} [mm]	h_{ef} [mm]	t_{fix} [mm]	$S_{cr,N}$ [mm]	$C_{cr,N}$ [mm]	$S_{cr,sp}$ [mm]	$C_{cr,sp}$ [mm]	
THE	THE05040	Ø5 x 40(A)	✓*	5	6,5 - 8	SW 8	8	35	35	--	--	--	--	--	--	--	--	--	80	45	35	26,5	5	80	40	80	40	
	THE05050	Ø5 x 50(A)	✓*			SW 8				5	105	53	105	53	15													
	THE05060	Ø5 x 60(B)	✓*			SW 8				15	105	53	105	53	35													
	THE05080	Ø5 x 80(D)	✓*			SW 8				35	105	53	105	53	45													
	THE05100	Ø5 x 100(E)	✓*			SW 8				55	105	53	105	53	65													
	THE06035	Ø6 x 35	✓	6	7,5 - 9	SW 10	10	35	35	--	--	--	--	--	--	--	--	--	--	100	45	35	26,0	5	100	39	90	45
	THE06040	Ø6 x 40	✓			SW 10				5	129	65	170	85	10													
	THE06045	Ø6 x 45	✓			SW 10				10	129	65	170	85	15													
	THE06050	Ø6 x 50	✓			SW 10				15	129	65	170	85	25													
	THE06060	Ø6 x 60	✓			SW 10				35	129	65	170	85	35													
	THE06070	Ø6 x 70	✓			SW 10				45	129	65	170	85	45													
	THE06080	Ø6 x 80	✓			SW 10				65	129	65	170	85	65													
	THE06100	Ø6 x 100	✓			SW 10				85	129	65	170	85	85													
	THE06120	Ø6 x 120	✓			SW 10				100	129	65	170	85	100													
	THE08055	Ø8 x 55	✓			8				10,5 - 12	SW 13	20	35	35	--	--	--	--	--									
	THE08060	Ø8 x 60	✓	SW 13	10		152	76	200		100				10													
	THE08070	Ø8 x 70	✓	SW 13	20		152	76	200		100				20													
	THE08075	Ø8 x 75	✓	SW 13	25		152	76	200		100				25													
	THE08080	Ø8 x 80	✓	SW 13	30		152	76	200		100				30													
	THE08090	Ø8 x 90	✓	SW 13	40		152	76	200		100				40													
	THE08100	Ø8 x 100	✓	SW 13	50		152	76	200		100				50													
	THE08110	Ø8 x 110	✓	SW 13	60		152	76	200		100				60													
	THE08120	Ø8 x 120	✓	SW 13	70		152	76	200		100				70													
	THE08140	Ø8 x 140	✓	SW 13	100		152	76	200		100				100													

*Ø5 Approuvé uniquement pour un emploi sur le béton et sur dalles alvéolaires préfabriquées pour des systèmes non-structuraux redondants

Paramètres généraux d'installation										Profondeur d'installation standard ($h_{ef, std}$)								Profondeur d'installation réduite ($h_{ef, red}$)										
Famille	Code	Dimension (Lettre)	Evaluation	Diamètre du foret	Diamètre du trou d'épaisseur à fixer	Version du tête	Couple de serrage maximal	Distance minimale entre axes	Distance minimale au bord	Épaisseur minimale du béton	Profondeur du trou foré	Profondeur d'installation	Profondeur effective	Épaisseur à fixer	Distance minimale entre axes (cône)	Distance critique au bord (cône)	Distance minimale entre axes (fissuration)	Distance critique au bord (fissuration)	Épaisseur minimale du béton	Profondeur du trou foré	Profondeur d'installation	Profondeur effective	Épaisseur à fixer	Distance minimale entre axes (cône)	Distance critique au bord (cône)	Distance minimale entre axes (fissuration)	Distance critique au bord (fissuration)	
[--]	[--]	[--]	ETA	d_o	d_f	SW/Tx	T_{inst}	S_{min}	C_{min}	h_{min}	h_1	h_{nom}	h_{ef}	t_{fix}	$S_{cr,N}$	$C_{cr,N}$	$S_{cr,sp}$	$C_{cr,sp}$	h_{min}	h_1	h_{nom}	h_{ef}	t_{fix}	$S_{cr,N}$	$C_{cr,N}$	$S_{cr,sp}$	$C_{cr,sp}$	
				[mm]	[mm]	[--]	[Nm]	[mm]	[mm]	[mm]	[mm]	[mm]	[mm]	[mm]	[mm]	[mm]	[mm]	[mm]	[mm]	[mm]	[mm]	[mm]	[mm]	[mm]	[mm]	[mm]	[mm]	[mm]
THE	THE10060	Ø10 x 60	✓	10	12,5 - 14	SW 15	30	50	40	--	--	--	--	--	--	--	--	--	100	65	55	41,5	5	125	63	140	70	
	THE10070	Ø10 x 70	✓			15																						
	THE10080	Ø10 x 80	✓			25																						
	THE10090	Ø10 x 90	✓			35																						
	THE10100	Ø10 x 100	✓			5																						
	THE10120	Ø10 x 120	✓			15																						
	THE10140	Ø10 x 140	✓			35																						
	THE10160	Ø10 x 160	✓			55																						
	THE10180	Ø10 x 180	✓			75																						
	THE12080	Ø12 x 80	✓	12	14,8 - 16	SW 15	50	75	45	--	--	--	--	--	--	--	--	--	120	90	75	58,0	5	174	87	190	95	
	THE12090	Ø12 x 90	✓			15																						
	THE12100	Ø12 x 100	✓			25																						
	THE12110	Ø12 x 110	✓			35																						
	THE12130	Ø12 x 130	✓			5																						
	THE12150	Ø12 x 150	✓			25																						
	THE14080	Ø14 x 80	✓	14	16,9 - 18	SW 18	70	80	50	--	--	--	--	--	--	--	--	--	120	90	75	58,0	5	174	87	190	95	
	THE14100	Ø14 x 100	✓			15																						
	THE14110	Ø14 x 110	✓			25																						
	THE14120	Ø14 x 120	✓			35																						
	THE14130	Ø14 x 130	✓			5																						
	THE14140	Ø14 x 140	✓			15																						
	THE14160	Ø14 x 160	✓			25																						
	THE16100	Ø16 x 100	✓	16	18,9 - 20	SW 21	80	80	50	--	--	--	--	--	--	--	--	--	115	100	80	58	20	174	87	180	90	
	THE16150	Ø16 x 150	✓			70																						
THE18100	Ø18 x 100	✓	10																									
THE18130	Ø18 x 130	✓	18	20,9 - 22	SW 21	90	90	55	--	--	--	--	--	--	--	--	--	140	110	90	69,5	40	209	105	230	115		
THE18160	Ø18 x 160	✓			70																							
THE18180	Ø18 x 180	✓			20																							
THE18200	Ø18 x 200	✓			40																							

Paramètres généraux d'installation				Profondeur d'installation standard ($h_{ef, std}$)														Profondeur d'installation réduite ($h_{ef, red}$)										
Famille	Code	Dimension (Lettre)	Evaluation	Diamètre du foret	Diamètre du trou d'épaisseur à fixer	Version du tête	Couple de serrage maximal	Distance minimale entre axes	Distance minimale au bord	Épaisseur minimale du béton	Profondeur du trou foré	Profondeur d'installation	Profondeur effective	Épaisseur à fixer	Distance minimale entre axes (cône)	Distance critique au bord (cône)	Distance minimale entre axes (fissuration)	Distance critique au bord (fissuration)	Épaisseur minimale du béton	Profondeur du trou foré	Profondeur d'installation	Profondeur effective	Épaisseur à fixer	Distance minimale entre axes (cône)	Distance critique au bord (cône)	Distance minimale entre axes (fissuration)	Distance critique au bord (fissuration)	
[--]	[--]	[--]	ETA	d_0	d_f	SW/Tx	T_{inst}	S_{min}	C_{min}	h_{min}	h_1	h_{nom}	h_{ef}	t_{fix}	$S_{cr,N}$	$C_{cr,N}$	$S_{cr,sp}$	$C_{cr,sp}$	h_{min}	h_1	h_{nom}	h_{ef}	t_{fix}	$S_{cr,N}$	$C_{cr,N}$	$S_{cr,sp}$	$C_{cr,sp}$	
				[mm]	[mm]	[--]	[Nm]	[mm]	[mm]	[mm]	[mm]	[mm]	[mm]	[mm]	[mm]	[mm]	[mm]	[mm]	[mm]	[mm]	[mm]	[mm]	[mm]	[mm]	[mm]	[mm]	[mm]	[mm]
THA	THA05040	Ø5 x 40(A)	✓*	5	6,5 - 8	TX25	8	35	35	80	55	45	35,0	15	105	53	105	53	80	45	35	26,5	5	80	40	80	40	
	THA05060	Ø5 x 60(B)	✓*			TX25																						25
	THA05080	Ø5 x 80(D)	✓*			TX25																						45
	THA05100	Ø5 x 100(E)	✓*			TX25																						65
	THA06045	Ø6 x 45	✓	6	7,5 - 9	TX30	10	35	35	100	65	55	43,0	5	129	65	170	85	100	45	35	26,0	10	78	39	90	45	
	THA06050	Ø6 x 50	✓			TX30																						15
	THA06060	Ø6 x 60	✓			TX30																						25
	THA06080	Ø6 x 80	✓			TX30																						45
	THA06100	Ø6 x 100	✓			TX30																						65
	THA06120	Ø6 x 120	✓			TX30																						85
	THA06140	Ø6 x 140	✓	TX30	105																							
	THA08060	Ø8 x 60	✓	8	10,5 - 12	TX45	20	35	35	100	75	65	50,5	15	152	76	200	100	100	60	50	37,5	10	113	57	130	65	
	THA08080	Ø8 x 80	✓			TX45																						30
	THA08100	Ø8 x 100	✓			TX45																						50
THA08120	Ø8 x 120	✓	TX45			70																						
THA10100	Ø10 x 100	✓	10	12,5 - 14	TX50	30	50	40	135	95	85	67,0	15	201	101	210	105	100	65	55	41,5	45	125	63	140	70		
THA10120	Ø10 x 120	✓			TX50																						65	
THT	THT06040	Ø6 x 40	✓	6	7,5 - 9	TX30	10	35	35	100	65	55	43,0	5	129	65	170	85	100	45	35	26,0	5	78	39	90	45	
	THT06050	Ø6 x 50	✓			TX30																						15
	THT06060	Ø6 x 60	✓			TX30																						25
THP	THP05040	Ø5 x 40(A)	✓*	5	6,5 - 8	TX30	8	35	35	80	55	45	35,0	15	105	53	105	53	80	45	35	26,5	5	80	40	80	40	
	THP05060	Ø5 x 60(B)	✓*			TX30																						25
	THP06040	Ø6 x 40	✓	6	7,5 - 9	TX40	10	35	35	100	65	55	43,0	5	129	65	170	85	100	45	35	26,0	15	78	39	90	45	
	THP06050	Ø6 x 50	✓			TX40																						25
	THP06060	Ø6 x 60	✓			TX40																						45
	THP06080	Ø6 x 80	✓			TX40																						65
	THP06100	Ø6 x 100	✓	TX40	85																							
	THP08060	Ø8 x 60	✓	8	10,5 - 12	TX45	20	35	35	100	75	65	50,5	15	152	76	200	100	100	60	50	37,5	10	113	57	130	65	
THP08080	Ø8 x 80	✓	TX45			30																						

*Ø5 Approuvé uniquement pour un emploi sur le béton et sur dalles alvéolaires préfabriquées pour des systèmes non-structuraux redondants

4. PARAMETRES D'INSTALLATION (DALLE ALVÉOLAIRE) [Profondeur d'installation réduite /intermédiaire/standard]

Paramètres généraux d'installation				Profondeur d'installation (h_{ef1} / h_{ef2} / h_{ef3})														
Famille	Code	Dimension (Lettre)	Evaluation	Diamètre du foret	Diamètre du trou d'épaisseur à fixer	Version du tête	Couple de serrage maximal	Distance minimale entre axes	Distance minimale au bord	Épaisseur du fond de la dalle	Profondeur du trou foré	Profondeur d'installation	Profondeur effective	Épaisseur à fixer	Distance minimale entre axes (cône)	Distance critique au bord (cône)	Distance minimale entre axes (fissuration)	Distance critique au bord (fissuration)
[--]	[--]	[--]	ETA	d_0 [mm]	d_f [mm]	SW/Tx [--]	T_{inst} [Nm]	S_{min} [mm]	C_{min} [mm]	d_b [mm]	h_1 [mm]	h_{nom} [mm]	h_{ef} [mm]	t_{fix} [mm]	$S_{cr,N}$ [mm]	$C_{cr,N}$ [mm]	$S_{cr,sp}$ [mm]	$C_{cr,sp}$ [mm]
THE	THE05040	Ø5 x 40(A)	✓*	5	6,5 - 8	SW 8	8	35	35	25/30/40	30/40/45	30/40/45	20/22/26,5	10/--/--	60/66/80	30/33/40	80	80
	THE05050	Ø5 x 50(A)	✓*			20/10/5												
	THE05060	Ø5 x 60(B)	✓*			30/20/15												
	THE05080	Ø5 x 80(D)	✓*			50/40/35												
	THE05100	Ø5 x 100(E)	✓*			70/60/55												
	THE06035	Ø6 x 35	✓	6	7,5 - 9	SW 10	10	35	35	25/30/40	30/40/45	30/40/45	20/22/26	5/--/--	60/66/78	30/33/39	90	45
	THE06040	Ø6 x 40	✓			10/--/--												
	THE06045	Ø6 x 45	✓			15/5/--												
	THE06050	Ø6 x 50	✓			20/10/5												
	THE06060	Ø6 x 60	✓			30/20/15												
	THE06070	Ø6 x 70	✓			40/30/25												
	THE06080	Ø6 x 80	✓			50/40/35												
THE06100	Ø6 x 100	✓	70/60/55															
THE06120	Ø6 x 120	✓	90/80/75															
THE06140	Ø6 x 140	✓																
THA	THA05040	Ø5 x 40(A)	✓*	5	6,5 - 8	TX25	8	35	35	25/30/40	30/40/45	30/40/45	20/22/26,5	10/--/--	60/66/80	30/33/40	80	80
	THA05060	Ø5 x 60(B)	✓*			30/20/15												
	THA05080	Ø5 x 80(D)	✓*			50/40/35												
	THA05100	Ø5 x 100(E)	✓*			70/60/55												
	THA06045	Ø6 x 45	✓	6	7,5 - 9	TX30	10	35	35	25/30/40	30/40/45	30/40/45	20/22/26	15/5/--	60/66/78	30/33/39	90	45
	THA06050	Ø6 x 50	✓			20/10/5												
	THA06060	Ø6 x 60	✓			30/20/15												
	THA06080	Ø6 x 80	✓			50/40/35												
	THA06100	Ø6 x 100	✓			70/60/55												
	THA06120	Ø6 x 120	✓			90/80/75												
	THA06140	Ø6 x 140	✓			110/100/95												

*Ø5 Approuvé uniquement pour un emploi sur le béton et sur dalles alvéolaires préfabriquées pour des systèmes non-structuraux redondants

Paramètres généraux d'installation										Profondeur d'installation (h_{ef1} / h_{ef2} / h_{ef3})								
Famille	Code	Dimension (Lettre)	Evaluation	Diamètre du foret	Diamètre du trou d'épaisseur à fixer	Version du tête	Couple de serrage maximal	Distance minimale entre axes	Distance minimale au bord	Épaisseur du fond de la dalle	Profondeur du trou foré	Profondeur d'installation	Profondeur effective	Épaisseur à fixer	Distance minimale entre axes (cône)	Distance critique au bord (cône)	Distance minimale entre axes (fissuration)	Distance critique au bord (fissuration)
[--]	[--]	[--]	ETA	d_0	d_f	SW/Tx	T_{inst}	S_{min}	C_{min}	d_b	h_1	h_{nom}	h_{ef}	t_{fix}	$S_{cr,N}$	$C_{cr,N}$	$S_{cr,sp}$	$C_{cr,sp}$
				[mm]	[mm]	[--]	[Nm]	[mm]	[mm]	[mm]	[mm]	[mm]	[mm]	[mm]	[mm]	[mm]	[mm]	[mm]
THT	THT06040	Ø6 x 40	✓	6	7,5 - 9	TX30	10	35	35	25/30/40	30/40/45	30/40/45	20/22/26	10/--/--	60/66/78	30/33/39	90	45
	THT06050	Ø6 x 50	✓			TX30								20/10/5				
	THT06060	Ø6 x 60	✓			TX30								30/20/15				
THP	THP05040	Ø5 x 40(A)	✓*	5	6,5 - 8	TX30	8	35	35	25/30/40	30/40/45	30/40/45	20/22/26,5	10/--/--	60/66/80	30/33/40	80	80
	THP05060	Ø5 x 60(B)	✓*			TX30								30/20/15				
	THP06040	Ø6 x 40	✓	6	7,5 - 9	TX40	10	35	35	25/30/40	30/40/45	30/40/45	20/22/26	10/--/--	60/66/78	30/33/39	90	45
	THP06050	Ø6 x 50	✓			TX40								20/10/5				
	THP06060	Ø6 x 60	✓			TX40								30/20/15				
	THP06080	Ø6 x 80	✓			TX40								50/40/35				
	THP06100	Ø6 x 100	✓			TX40								70/60/55				

*Ø5 Approuvé uniquement pour un emploi sur le béton et sur dalles alvéolaires préfabriquées pour des systèmes non-structuraux redondants

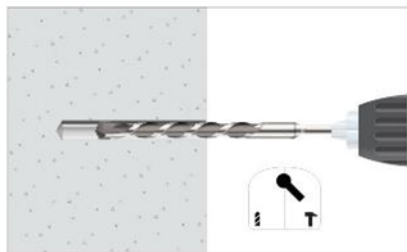
5. PROCESSUS D'INSTALLATION**5.1. INSTALLATION DANS LE BÉTON ET DALLE ALVÉOLAIRE****1. PERCER**

Vérifier que le béton est bien compact et sans pores significatifs.
Admet des trous secs, humides ou inondés.
Perçage en mode percussion ou marteau.
Percer au diamètre et à la profondeur spécifiée.

**2. SOUFLER ET NETTOYER**

Nettoyer le trou des restes de poussière et des fragments du perçage.
Utiliser bombe d'air et brosse

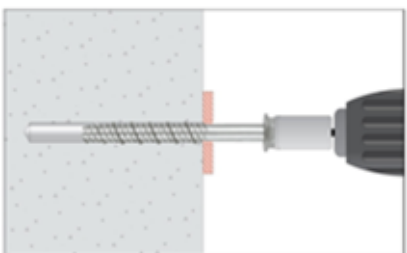
**3. INSTALLER**

Utiliser une clé à choc ou une clé dynamométrique ne dépassant pas les couples de serrage maximaux Timpact,max ou Tins,max respectivement.
Connecter la douille d'installation ou la pointe hexagonal.
Assembler la tête de la vis dans la douille/pointe.

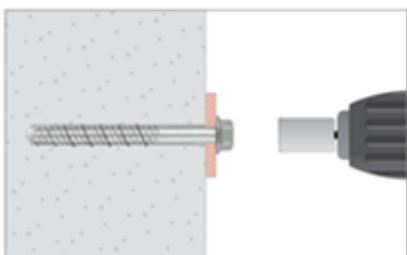
**4. APPLIQUER COUPLE DE SERRAGE**

Insérer la vis dans le trou avec une clé à choc ou une clé dynamométrique à travers la plaque d'ancrage jusqu'à ce que la tête soit en contact avec la plaque. La vis doit rester serrée après l'installation et ne doit plus être desserrée.

6. RÉISTANCES (BÉTON)

Les résistances dans le béton C20 / 25 pour un ancrage isolé sans effets de la distance au bord et des distances entre les ancrages sont indiquées dans le tableau suivant :

Les valeurs *soulignées et en italique* indiquent une défaillance de l'acier, les valeurs en **gras** indiquent une défaillance par le béton et le reste indique une défaillance par extraction.

1 KN ≈ 100 kg

6.1 RESISTANCES CHARACTERISTIQUES (APPLICATION STRUCTURELLE) [kN]

Paramètres généraux				Béton non-fissuré				Béton fissuré											
Famille	Code	Dimension	Evaluation ETA	Traction $N_{Rk, ucr}$		Cisaillement $V_{Rk, ucr}$		Traction $N_{Rk, ucr}$		Cisaillement $V_{Rk, ucr}$									
				($h_{ef, std}$)	($h_{ef, red}$)	($h_{ef, std}$)	($h_{ef, red}$)	($h_{ef, std}$)	($h_{ef, red}$)	($h_{ef, std}$)	($h_{ef, red}$)								
THE	THE05040	Ø5 x 40	✓*	--	6,71	--	6,71	--	4,70	--	4,70								
	THE05050	Ø5 x 50	✓*	10,19	6,71	<u><i>8,19</i></u>	6,71	7,13	4,70	7,13	4,70								
	THE05060	Ø5 x 60	✓*																
	THE05080	Ø5 x 80	✓*																
	THE05100	Ø5 x 100	✓*																
	THE06035	Ø6 x 35	✓	--	5,00	--	<u><i>12,53</i></u>	--	4,57	--	9,36								
	THE06040	Ø6 x 40	✓																
	THE06045	Ø6 x 45	✓																
	THE06050	Ø6 x 50	✓																
	THE06060	Ø6 x 60	✓	13,87	5,00	<u><i>12,53</i></u>	<u><i>12,53</i></u>	9,71	4,57	11,17	9,36								
	THE06070	Ø6 x 70	✓																
	THE06080	Ø6 x 80	✓																
	THE06100	Ø6 x 100	✓																
	THE06120	Ø6 x 120	✓																
	THE08055	Ø8 x 55	✓									--	11,30	--	<u><i>19,57</i></u>	--	7,91	--	14,23
	THE08060	Ø8 x 60	✓																
	THE08070	Ø8 x 70	✓									17,65	11,30	<u><i>19,57</i></u>	<u><i>19,57</i></u>	12,36	7,91	15,69	14,23
	THE08075	Ø8 x 75	✓																
	THE08080	Ø8 x 80	✓																
	THE08090	Ø8 x 90	✓																
	THE08100	Ø8 x 100	✓																
	THE08110	Ø8 x 110	✓																
	THE08120	Ø8 x 120	✓																
	THE08140	Ø8 x 140	✓																
	THE10060	Ø10 x 60	✓	--	13,15	--	25,65	--	9,21	--	17,95								
	THE10070	Ø10 x 70	✓																
	THE10080	Ø10 x 80	✓																
	THE10090	Ø10 x 90	✓																
	THE10100	Ø10 x 100	✓	26,98	13,15	<u><i>27,40</i></u>	25,65	18,89	9,21	<u><i>27,40</i></u>	17,95								
	THE10120	Ø10 x 120	✓																
	THE10140	Ø10 x 140	✓																
	THE10160	Ø10 x 160	✓																
	THE10180	Ø10 x 180	✓																
	THE12080	Ø12 x 80	✓									--	21,73	--	<u><i>37,24</i></u>	--	15,21	--	35,44
	THE12090	Ø12 x 90	✓																
	THE12100	Ø12 x 100	✓																
	THE12110	Ø12 x 110	✓	37,54	21,73	<u><i>37,24</i></u>	<u><i>37,24</i></u>	26,27	15,21	<u><i>37,24</i></u>	35,44								
	THE12130	Ø12 x 130	✓																
	THE12150	Ø12 x 150	✓																
	THE14080	Ø14 x 80	✓									--	21,73	--	<u><i>52,72</i></u>	--	15,21	--	38,79
THE14100	Ø14 x 100	✓																	
THE14110	Ø14 x 110	✓																	
THE14120	Ø14 x 120	✓																	
THE14130	Ø14 x 130	✓	43,41	21,73	<u><i>52,72</i></u>	<u><i>52,72</i></u>	30,39	15,21	<u><i>52,72</i></u>	38,79									
THE14140	Ø14 x 140	✓																	
THE14160	Ø14 x 160	✓																	
TFE16100	Ø16 x 100	✓									--	43,41	21,73	<u><i>57,97</i></u>	46,50	30,39	15,21	<u><i>52,72</i></u>	32,55
TFE16150	Ø16 x 150	✓																	
THE18100	Ø18 x 100	✓	--	28,50	--	75,82	--	19,95	--	53,07									
THE18130	Ø18 x 130	✓																	
THE18160	Ø18 x 160	✓																	
THE18180	Ø18 x 180	✓																	
THE18200	Ø18 x 200	✓	58,31	28,50	<u><i>80,78</i></u>	75,82	40,82	19,95	<u><i>80,78</i></u>	53,07									

*Ø5 Approuvé uniquement pour un emploi sur le béton et sur dalles alvéolaires préfabriquées pour des systèmes non-structurels redondants

Paramètres généraux				Béton non-fissuré				Béton fissuré			
Familie	Code	Dimension	Evaluation ETA	Traction $N_{Rk, ucr}$		Cisaillement $V_{Rk, ucr}$		Traction $N_{Rk, ucr}$		Cisaillement $V_{Rk, ucr}$	
				($h_{ef, std}$)	($h_{ef, red}$)	($h_{ef, std}$)	($h_{ef, red}$)	($h_{ef, std}$)	($h_{ef, red}$)	($h_{ef, std}$)	($h_{ef, red}$)
THA	THA05040	Ø5 x 40	✓*	--	6,71	--	6,71	--	4,70	--	4,70
	THA05060	Ø5 x 60	✓*	10,19	6,71	<u>8,19</u>	6,71	7,13	4,70	7,13	4,70
	THA05080	Ø5 x 80	✓*								
	THA05100	Ø5 x 100	✓*								
	THA06045	Ø6 x 45	✓	--	5,00	--	<u>12,53</u>	--	4,57	--	9,36
	THA06050	Ø6 x 50	✓								
	THA06060	Ø6 x 60	✓	13,87	5,00	<u>12,53</u>	<u>12,53</u>	9,71	4,57	11,17	9,36
	THA06080	Ø6 x 80	✓								
	THA06100	Ø6 x 100	✓								
	THA06120	Ø6 x 120	✓								
	THA06140	Ø6 x 140	✓	17,65	11,30	<u>19,57</u>	<u>19,57</u>	12,36	7,91	15,69	14,23
	THA08060	Ø8 x 60	✓								
	THA08080	Ø8 x 80	✓								
	THA08100	Ø8 x 100	✓								
THA08120	Ø8 x 120	✓	26,98	13,15	<u>27,40</u>	25,65	18,89	9,21	<u>27,40</u>	17,95	
THA10100	Ø10 x 100	✓									
THA10120	Ø10 x 120	✓									
THT	THT06040	Ø6 x 40	✓	--	5,00	--	<u>12,53</u>	--	4,57	--	9,36
	THT06050	Ø6 x 50	✓								
	THT06060	Ø6 x 60	✓	13,87	5,00	<u>12,53</u>	<u>12,53</u>	9,71	4,57	11,17	9,36
THP	THP05040	Ø5 x 40	✓*	--	6,71	--	6,71	--	4,70	--	4,70
	THP05060	Ø5 x 60	✓*	10,19	6,71	<u>8,19</u>	6,71	7,13	4,70	7,13	4,70
	THP06040	Ø6 x 40	✓								
	THP06050	Ø6 x 50	✓								
	THP06060	Ø6 x 60	✓	13,87	5,00	<u>12,53</u>	<u>12,53</u>	9,71	4,57	11,17	9,36
	THP06080	Ø6 x 80	✓								
	THP06100	Ø6 x 100	✓								
	THP08060	Ø8 x 60	✓								
THP08080	Ø8 x 80	✓	17,65	11,30	--	<u>19,57</u>	--	7,91	--	14,23	
			17,65	11,30	<u>19,57</u>	<u>19,57</u>	12,36	7,91	15,69	14,23	

*Ø5 Approuvé uniquement pour un emploi sur le béton et sur dalles alvéolaires préfabriquées pour des systèmes non-structuraux redondants

6.2 RESISTANCES DE CALCUL (APPLICATION STRUCTURELLE) [kN]

Paramètres généraux				Béton non-fissuré				Béton fissuré			
Familie	Code	Dimension	Evaluation ETA	Traction $N_{Rk, ucr}$		Cisaillement $V_{Rk, ucr}$		Traction $N_{Rk, ucr}$		Cisaillement $V_{Rk, ucr}$	
				($h_{ef, std}$)	($h_{ef, red}$)	($h_{ef, std}$)	($h_{ef, red}$)	($h_{ef, std}$)	($h_{ef, red}$)	($h_{ef, std}$)	($h_{ef, red}$)
THE	THE05040	Ø5 x 40	✓*	--	4,47	--	4,47	--	3,13	--	3,13
	THE05050	Ø5 x 50	✓*	6,79	4,47	5,46	4,47	4,75	3,13	4,75	3,13
	THE05060	Ø5 x 60	✓*								
	THE05080	Ø5 x 80	✓*								
	THE05100	Ø5 x 100	✓*								
	THE06035	Ø6 x 35	✓	--	2,78	--	8,35	--	2,54	--	6,24
	THE06040	Ø6 x 40	✓	--		--		--			
	THE06045	Ø6 x 45	✓	--		--		--			
	THE06050	Ø6 x 50	✓	--		--		--			
	THE06060	Ø6 x 60	✓	9,25	2,78	8,35	8,35	6,47	2,54	7,44	6,24
	THE06070	Ø6 x 70	✓								
	THE06080	Ø6 x 80	✓								
	THE06100	Ø6 x 100	✓								
	THE06120	Ø6 x 120	✓	11,77	6,28	13,05	13,05	8,24	4,39	10,46	9,49
	THE08055	Ø8 x 55	✓								
	THE08060	Ø8 x 60	✓								
	THE08070	Ø8 x 70	✓								
	THE08075	Ø8 x 75	✓								
	THE08080	Ø8 x 80	✓								
	THE08090	Ø8 x 90	✓								
	THE08100	Ø8 x 100	✓								
	THE08110	Ø8 x 110	✓								
	THE08120	Ø8 x 120	✓	17,99	8,77	18,27	17,10	12,59	6,14	18,27	11,97
	THE08140	Ø8 x 140	✓								
	THE10060	Ø10 x 60	✓								
	THE10070	Ø10 x 70	✓								
	THE10080	Ø10 x 80	✓	--	21,73	--	52,72	--	15,21	--	38,79
	THE10090	Ø10 x 90	✓								
	THE10100	Ø10 x 100	✓								
	THE10120	Ø10 x 120	✓								
	THE10140	Ø10 x 140	✓	43,41	21,73	52,72	52,72	30,39	15,21	52,72	38,79
	THE10160	Ø10 x 160	✓								
THE10180	Ø10 x 180	✓									
THE12080	Ø12 x 80	✓									
THE12090	Ø12 x 90	✓	--	14,49	--	24,83	--	10,14	--	23,63	
THE12100	Ø12 x 100	✓									
THE12110	Ø12 x 110	✓									
THE12130	Ø12 x 130	✓									
THE12150	Ø12 x 150	✓	25,02	14,49	24,83	24,83	17,52	10,14	24,83	23,63	
THE14080	Ø14 x 80	✓									
THE14100	Ø14 x 100	✓									
THE14110	Ø14 x 110	✓									
THE14120	Ø14 x 120	✓	43,41	21,73	52,72	52,72	30,39	15,21	52,72	38,79	
THE14130	Ø14 x 130	✓									
THE14140	Ø14 x 140	✓									
THE14160	Ø14 x 160	✓									
TFE16100	Ø16 x 100	✓	--	--	--	--	20,26	10,14	38,65	21,70	
TFE16150	Ø16 x 150	✓	28,94	14,49	38,65	31,00					
THE18100	Ø18 x 100	✓	--	19,00	--	50,54	--	13,30	--	35,38	
THE18130	Ø18 x 130	✓									
THE18160	Ø18 x 160	✓	38,87	19,00	53,85	50,54	27,21	13,30	53,85	35,38	
THE18180	Ø18 x 180	✓									
THE18200	Ø18 x 200	✓									

*Ø5 Approuvé uniquement pour un emploi sur le béton et sur dalles alvéolaires préfabriquées pour des systèmes non-structuraux redondants

Paramètres généraux				Béton non-fissuré				Béton fissuré			
Familie	Code	Dimension	Evaluation ETA	Traction $N_{Rk, ucr}$		Cisaillement $V_{Rk, ucr}$		Traction $N_{Rk, ucr}$		Cisaillement $V_{Rk, ucr}$	
				($h_{ef, std}$)	($h_{ef, red}$)	($h_{ef, std}$)	($h_{ef, red}$)	($h_{ef, std}$)	($h_{ef, red}$)	($h_{ef, std}$)	($h_{ef, red}$)
THA	THA05040	Ø5 x 40	✓*	--	4,47	--	4,47	--	3,13	--	3,13
	THA05060	Ø5 x 60	✓*	6,79	4,47	<u>5,46</u>	4,47	4,75	3,13	4,75	3,13
	THA05080	Ø5 x 80	✓*								
	THA05100	Ø5 x 100	✓*								
	THA06045	Ø6 x 45	✓	--	2,78	--	<u>8,35</u>	--	2,54	--	6,24
	THA06050	Ø6 x 50	✓								
	THA06060	Ø6 x 60	✓	9,25	2,78	<u>8,35</u>	<u>8,35</u>	6,47	2,54	7,44	6,24
	THA06080	Ø6 x 80	✓								
	THA06100	Ø6 x 100	✓								
	THA06120	Ø6 x 120	✓								
	THA06140	Ø6 x 140	✓	11,77	6,28	<u>13,05</u>	<u>13,05</u>	8,24	4,39	10,46	9,49
	THA08060	Ø8 x 60	✓								
	THA08080	Ø8 x 80	✓								
	THA08100	Ø8 x 100	✓								
THA08120	Ø8 x 120	✓									
THA10100	Ø10 x 100	✓	17,99	8,77	<u>18,27</u>	17,10	12,59	6,14	<u>18,27</u>	11,97	
THA10120	Ø10 x 120	✓									
THT	THT06040	Ø6 x 40	✓	--	2,78	--	<u>8,35</u>	--	2,54	--	6,24
	THT06050	Ø6 x 50	✓								
	THT06060	Ø6 x 60	✓	9,25	2,78	<u>8,35</u>	<u>8,35</u>	6,47	2,54	7,44	6,24
THP	THP05040	Ø5 x 40	✓*	--	4,47	--	4,47	--	3,13	--	3,13
	THP05060	Ø5 x 60	✓*	6,79	4,47	<u>5,46</u>	4,47	4,75	3,13	4,75	3,13
	THP06040	Ø6 x 40	✓	--	2,78	--	<u>8,35</u>	--	2,54	--	6,24
	THP06050	Ø6 x 50	✓								
	THP06060	Ø6 x 60	✓	9,25	2,78	<u>8,35</u>	<u>8,35</u>	6,47	2,54	7,44	6,24
	THP06080	Ø6 x 80	✓								
	THP06100	Ø6 x 100	✓								
	THP08060	Ø8 x 60	✓	--	6,28	--	<u>13,05</u>	--	4,39	--	9,49
THP08080	Ø8 x 80	✓	11,77	6,28	<u>13,05</u>	<u>13,05</u>	8,24	4,39	10,46	9,49	

*Ø5 Approuvé uniquement pour un emploi sur le béton et sur dalles alvéolaires préfabriquées pour des systèmes non-structuraux redondants

6.3 CHARGES MAXIMALES RECOMMANDÉES (APPLICATION STRUCTURELLE) [kN] (avec $\gamma_F=1.4$)

Paramètres généraux				Béton non-fissuré				Béton fissuré										
Familie	Code	Dimension	Evaluation ETA	Traction $N_{Rk, ucr}$		Cisaillement $V_{Rk, ucr}$		Traction $N_{Rk, ucr}$		Cisaillement $V_{Rk, ucr}$								
				($h_{ef, std}$)	($h_{ef, red}$)	($h_{ef, std}$)	($h_{ef, red}$)	($h_{ef, std}$)	($h_{ef, red}$)	($h_{ef, std}$)	($h_{ef, red}$)							
THE	THE05040	Ø5 x 40	✓*	--	3,20	--	3,20	--	2,24	--	2,24							
	THE05050	Ø5 x 50	✓*	4,85	3,20	<u>3,90</u>	3,20	3,40	2,24	3,40	2,24							
	THE05060	Ø5 x 60	✓*															
	THE05080	Ø5 x 80	✓*															
	THE05100	Ø5 x 100	✓*															
	THE06035	Ø6 x 35	✓	--	1,98	--	<u>5,97</u>	--	1,81	--	4,46							
	THE06040	Ø6 x 40	✓	--		--												
	THE06045	Ø6 x 45	✓	--		--												
	THE06050	Ø6 x 50	✓	--		--												
	THE06060	Ø6 x 60	✓	6,61	1,98	<u>5,97</u>	<u>5,97</u>	4,62	1,81	5,32	4,46							
	THE06070	Ø6 x 70	✓															
	THE06080	Ø6 x 80	✓															
	THE06100	Ø6 x 100	✓															
	THE06120	Ø6 x 120	✓	8,41	4,48	<u>9,32</u>	<u>9,32</u>	5,88	3,14	7,47	6,78							
	THE08055	Ø8 x 55	✓															
	THE08060	Ø8 x 60	✓															
	THE08070	Ø8 x 70	✓															
	THE08075	Ø8 x 75	✓	8,41	4,48	<u>9,32</u>	<u>9,32</u>	5,88	3,14	7,47	6,78							
	THE08080	Ø8 x 80	✓															
	THE08090	Ø8 x 90	✓															
	THE08100	Ø8 x 100	✓															
	THE08110	Ø8 x 110	✓	8,41	4,48	<u>9,32</u>	<u>9,32</u>	5,88	3,14	7,47	6,78							
	THE08120	Ø8 x 120	✓															
	THE08140	Ø8 x 140	✓															
	THE10060	Ø10 x 60	✓									--	6,26	--	12,21	--	4,38	--
	THE10070	Ø10 x 70	✓	--	--													
	THE10080	Ø10 x 80	✓	--	--													
	THE10090	Ø10 x 90	✓	12,85	6,26	<u>13,05</u>	12,21	8,99	4,38	<u>13,05</u>	8,55							
	THE10100	Ø10 x 100	✓															
	THE10120	Ø10 x 120	✓															
	THE10140	Ø10 x 140	✓															
	THE10160	Ø10 x 160	✓	12,85	6,26	<u>13,05</u>	12,21	8,99	4,38	<u>13,05</u>	8,55							
THE10180	Ø10 x 180	✓																
THE12080	Ø12 x 80	✓	--									10,35	--	<u>17,73</u>	--	7,24	--	16,88
THE12090	Ø12 x 90	✓	--										--					
THE12100	Ø12 x 100	✓	--	--														
THE12110	Ø12 x 110	✓	17,87	10,35	<u>17,73</u>	<u>17,73</u>	12,51	7,24	<u>17,73</u>	16,88								
THE12130	Ø12 x 130	✓																
THE12150	Ø12 x 150	✓																
THE14080	Ø14 x 80	✓									--	10,35	--	<u>25,10</u>	--	7,24	--	18,47
THE14100	Ø14 x 100	✓	--	--														
THE14110	Ø14 x 110	✓	--	--														
THE14120	Ø14 x 120	✓	20,67	10,35	<u>25,10</u>	<u>25,10</u>	14,47	7,24	<u>25,10</u>	18,47								
THE14130	Ø14 x 130	✓																
THE14140	Ø14 x 140	✓																
THE14160	Ø14 x 160	✓																
TFE16100	Ø16 x 100	✓	--	--	--	--	14,47	7,24	<u>27,60</u>	15,50								
TFE16150	Ø16 x 150	✓	20,67	10,35	<u>27,60</u>	22,14												
THE18100	Ø18 x 100	✓	--	13,57	--	36,10	--	9,50	--	25,27								
THE18130	Ø18 x 130	✓	--		--													
THE18160	Ø18 x 160	✓	27,77	13,57	<u>38,47</u>	36,10	19,44	9,50	<u>38,47</u>	25,27								
THE18180	Ø18 x 180	✓																
THE18200	Ø18 x 200	✓																

*Ø5 Approuvé uniquement pour un emploi sur le béton et sur dalles alvéolaires préfabriquées pour des systèmes non-structuraux redondants

Paramètres généraux				Béton non-fissuré				Béton fissuré			
Familie	Code	Dimension	Evaluation ETA	Traction $N_{Rk, ucr}$		Cisaillement $V_{Rk, ucr}$		Traction $N_{Rk, ucr}$		Cisaillement $V_{Rk, ucr}$	
				($h_{ef, std}$)	($h_{ef, red}$)	($h_{ef, std}$)	($h_{ef, red}$)	($h_{ef, std}$)	($h_{ef, red}$)	($h_{ef, std}$)	($h_{ef, red}$)
THA	THA05040	Ø5 x 40	✓*	--	3,20	--	3,20	--	2,24	--	2,24
	THA05060	Ø5 x 60	✓*	4,85	3,20	<u>3,90</u>	3,20	3,40	2,24	3,40	2,24
	THA05080	Ø5 x 80	✓*								
	THA05100	Ø5 x 100	✓*								
	THA06045	Ø6 x 45	✓	--	1,98	--	<u>5,97</u>	--	1,81	--	4,46
	THA06050	Ø6 x 50	✓	6,61	1,98	<u>5,97</u>	<u>5,97</u>	4,62	1,81	5,32	4,46
	THA06060	Ø6 x 60	✓								
	THA06080	Ø6 x 80	✓								
	THA06100	Ø6 x 100	✓								
	THA06120	Ø6 x 120	✓								
	THA06140	Ø6 x 140	✓	8,41	4,48	<u>9,32</u>	<u>9,32</u>	5,88	3,14	7,47	6,78
	THA08060	Ø8 x 60	✓								
	THA08080	Ø8 x 80	✓								
	THA08100	Ø8 x 100	✓								
THA08120	Ø8 x 120	✓									
THA10100	Ø10 x 100	✓	12,85								
THA10120	Ø10 x 120	✓									
THT06040	Ø6 x 40	✓		--	1,98	--	<u>5,97</u>	--	1,81	--	4,46
THT	THT06050	Ø6 x 50	✓	6,61	1,98	<u>5,97</u>	<u>5,97</u>	4,62	1,81	5,32	4,46
	THT06060	Ø6 x 60	✓								
	THP05040	Ø5 x 40	✓*								
THP	THP05060	Ø5 x 60	✓*	4,85	3,20	<u>3,90</u>	3,20	3,40	2,24	3,40	2,24
	THP06040	Ø6 x 40	✓								
	THP06050	Ø6 x 50	✓	--	1,98	--	<u>5,97</u>	--	1,81	--	4,46
	THP06060	Ø6 x 60	✓	6,61	1,98	<u>5,97</u>	<u>5,97</u>	4,62	1,81	5,32	4,46
	THP06080	Ø6 x 80	✓								
	THP06100	Ø6 x 100	✓								
	THP08060	Ø8 x 60	✓	--	4,48	--	<u>9,32</u>	--	3,14	--	6,78
	THP08080	Ø8 x 80	✓	8,41	4,48	<u>9,32</u>	<u>9,32</u>	5,88	3,14	7,47	6,78

*Ø5 Approuvé uniquement pour un emploi sur le béton et sur dalles alvéolaires préfabriquées pour des systèmes non-structuraux redondants

COEFFICIENT DE MAJORATION A EXTRACTION POUR CHARGUES A TRACTION DANS DU BÉTON HAUTE RÉSIDENCE ψ_c															
Diamètre	Ø5		Ø6		Ø8		Ø10			Ø12		Ø14		Ø18	
Profondeur d'installation	($h_{ef, red}$)	($h_{ef, std}$)	($h_{ef, red}$)	($h_{ef, std}$)	($h_{ef, red}$)	($h_{ef, std}$)	($h_{ef, 1}$)	($h_{ef, 2}$)	($h_{ef, 3}$)	($h_{ef, red}$)	($h_{ef, std}$)	($h_{ef, red}$)	($h_{ef, std}$)	($h_{ef, red}$)	($h_{ef, std}$)
C30/37	1,00	1,00	1,16	1,22	1,21	1,22	1,22	1,17	1,22	1,16	1,22	1,21	1,20	1,22	1,17
C40/50	1,00	1,00	1,28	1,41	1,39	1,41	1,41	1,30	1,41	1,29	1,41	1,39	1,37	1,40	1,32
C50/60	1,00	1,00	1,39	1,58	1,54	1,58	1,58	1,42	1,58	1,40	1,58	1,55	1,51	1,57	1,42

7. RÉISTANCES (DALLE ALVÉOLAIRE)

Les résistances dans la dalle alvéolaire creux C30/37 pour un ancrage isolé sans effets de la distance au bord et des distances entre les ancrages sont indiquées dans le tableau suivant :

Les valeurs *soulignées et en italique* indiquent une défaillance de l'acier, les valeurs en **gras** indiquent une défaillance par le béton et le reste indique une défaillance par extraction.

1 KN ≈ 100 kg

7.1 RESISTANCES CHARACTERISTIQUES (APPLICATION NON STRUCTURELLE) [kN]

Paramètres généraux				Dalle alvéolaire creux					
Famille	Code	Dimension	Evaluation ETA	Traction N _{Rk}			Cisaillement V _{Rk}		
				(h _{ef1})	(h _{ef2})	(h _{ef3})	(h _{ef1})	(h _{ef2})	(h _{ef3})
THE	THE05040	Ø5 x 40	✓*	5,39	--	--	5,39	--	--
	THE05050	Ø5 x 50	✓*		--	--		--	--
	THE05060	Ø5 x 60	✓*		6,22	8,22		6,22	<u>8,19</u>
	THE05080	Ø5 x 80	✓*						
	THE05100	Ø5 x 100	✓*						
	THE06035	Ø6 x 35	✓	5,39	--	--	5,39	--	--
	THE06040	Ø6 x 40	✓		--	--		--	--
	THE06045	Ø6 x 45	✓		--	--		--	--
	THE06050	Ø6 x 50	✓		6,22	7,99		6,22	7,99
	THE06060	Ø6 x 60	✓						
	THE06070	Ø6 x 70	✓						
	THE06080	Ø6 x 80	✓						
	THE06100	Ø6 x 100	✓						
THE06120	Ø6 x 120	✓							
THA	THA05040	Ø5 x 40	✓*	5,39	--	--	5,39	--	--
	THA05060	Ø5 x 60	✓*		6,22	8,22		6,22	<u>8,19</u>
	THA05080	Ø5 x 80	✓*						
	THA05100	Ø5 x 100	✓*						
	THA06045	Ø6 x 45	✓	5,39	--	--	5,39	--	--
	THA06050	Ø6 x 50	✓		--	--		--	--
	THA06060	Ø6 x 60	✓		6,22	7,99		6,22	7,99
	THA06080	Ø6 x 80	✓						
	THA06100	Ø6 x 100	✓						
THT	THT06040	Ø6 x 40	✓	5,39	--	--	5,39	--	--
	THT06050	Ø6 x 50	✓		6,22	7,99		6,22	7,99
	THT06060	Ø6 x 60	✓						
THP	THP05040	Ø5 x 40	✓*	5,39	--	--	5,39	--	--
	THP05060	Ø5 x 60	✓*		6,22	8,22		6,22	<u>8,19</u>
	THP06040	Ø6 x 40	✓	5,39	--	--	5,39	--	--
	THP06050	Ø6 x 50	✓		6,22	7,99		6,22	7,99
	THP06060	Ø6 x 60	✓						
	THP06080	Ø6 x 80	✓						
THP06100	Ø6 x 100	✓							

*Ø5 Approuvé uniquement pour un emploi sur le béton et sur dalles alvéolaires préfabriquées pour des systèmes non-structuraux redondants

7.2 RESISTANCES DE CALCUL (APPLICATION NON STRUCTURELLE) [kN]									
Paramètres généraux				Dalle alvéolaire creux					
Famille	Code	Dimension	Evaluation ETA	Traction N_{Rd}			Cisaillement V_{Rd}		
				(h_{ef1})	(h_{ef2})	(h_{ef3})	(h_{ef1})	(h_{ef2})	(h_{ef3})
THE	THE05040	Ø5 x 40	✓*	2,99	--	--	3,59	--	--
	THE05050	Ø5 x 50	✓*		--	--		--	--
	THE05060	Ø5 x 60	✓*		3,45	4,57		4,14	5,46
	THE05080	Ø5 x 80	✓*		--	--		--	--
	THE05100	Ø5 x 100	✓*		--	--		--	--
	THE06035	Ø6 x 35	✓	2,99	--	--	3,59	--	--
	THE06040	Ø6 x 40	✓		--	--		--	--
	THE06045	Ø6 x 45	✓		--	--		--	--
	THE06050	Ø6 x 50	✓		3,45	4,44		4,14	5,33
	THE06060	Ø6 x 60	✓		--	--		--	--
	THE06070	Ø6 x 70	✓		--	--		--	--
	THE06080	Ø6 x 80	✓		--	--		--	--
THE06100	Ø6 x 100	✓	--	--	--	--			
THE06120	Ø6 x 120	✓	--	--	--	--			
THA	THA05040	Ø5 x 40	✓*	2,99	--	--	3,59	--	--
	THA05060	Ø5 x 60	✓*		3,45	4,57		4,14	5,46
	THA05080	Ø5 x 80	✓*		--	--		--	--
	THA05100	Ø5 x 100	✓*		--	--		--	--
	THA06045	Ø6 x 45	✓	2,99	--	--	3,59	--	--
	THA06050	Ø6 x 50	✓		3,45	4,44		4,14	5,33
	THA06060	Ø6 x 60	✓		--	--		--	--
	THA06080	Ø6 x 80	✓		--	--		--	--
	THA06100	Ø6 x 100	✓		--	--		--	--
THA06120	Ø6 x 120	✓	--	--	--	--			
THA06140	Ø6 x 140	✓	--	--	--	--			
THT	THT06040	Ø6 x 40	✓	2,99	--	--	3,59	--	--
	THT06050	Ø6 x 50	✓		3,45	4,44		4,14	5,33
	THT06060	Ø6 x 60	✓		--	--		--	--
THP	THP05040	Ø5 x 40	✓*	2,99	--	--	3,59	--	--
	THP05060	Ø5 x 60	✓*		3,45	4,57		4,14	5,46
	THP06040	Ø6 x 40	✓	2,99	--	--	3,59	--	--
	THP06050	Ø6 x 50	✓		3,45	4,44		4,14	5,33
	THP06060	Ø6 x 60	✓		--	--		--	--
	THP06080	Ø6 x 80	✓		--	--		--	--
THP06100	Ø6 x 100	✓	--	--	--	--			

*Ø5 Approuvé uniquement pour un emploi sur le béton et sur dalles alvéolaires préfabriquées pour des systèmes non-structuraux redondants

7.3 CHARGES MAXIMALES RECOMMANDÉES (APPLICATION NON STRUCTURELLE) [kN] (avec $\gamma_F= 1.4$)

Paramètres généraux				Dalle alvéolaire creux					
Famille	Code	Dimension	Evaluation ETA	Traction N_{rec}			Cisaillement V_{rec}		
				(h_{ef1})	(h_{ef2})	(h_{ef3})	(h_{ef1})	(h_{ef2})	(h_{ef3})
THE	THE05040	Ø5 x 40	✓*	2,14	--	--	2,57	--	--
	THE05050	Ø5 x 50	✓*		--	--		--	--
	THE05060	Ø5 x 60	✓*		2,47	3,26		2,96	3,90
	THE05080	Ø5 x 80	✓*		--	--		--	--
	THE05100	Ø5 x 100	✓*		--	--		--	--
	THE06035	Ø6 x 35	✓	2,14	--	--	2,57	--	--
	THE06040	Ø6 x 40	✓		--	--		--	--
	THE06045	Ø6 x 45	✓		--	--		--	--
	THE06050	Ø6 x 50	✓		2,47	3,17		2,96	3,80
	THE06060	Ø6 x 60	✓		--	--		--	--
	THE06070	Ø6 x 70	✓		--	--		--	--
	THE06080	Ø6 x 80	✓		--	--		--	--
THE06100	Ø6 x 100	✓	--	--	--	--			
THE06120	Ø6 x 120	✓	--	--	--	--			
THA	THA05040	Ø5 x 40	✓*	2,14	--	--	2,57	--	--
	THA05060	Ø5 x 60	✓*		2,47	3,26		2,96	3,90
	THA05080	Ø5 x 80	✓*		--	--		--	--
	THA05100	Ø5 x 100	✓*		--	--		--	--
	THA06045	Ø6 x 45	✓	2,14	--	--	2,57	--	--
	THA06050	Ø6 x 50	✓		2,47	3,17		2,96	3,80
	THA06060	Ø6 x 60	✓		--	--		--	--
	THA06080	Ø6 x 80	✓		--	--		--	--
	THA06100	Ø6 x 100	✓		--	--		--	--
THA06120	Ø6 x 120	✓	--	--	--	--			
THA06140	Ø6 x 140	✓	--	--	--	--			
THT	THT06040	Ø6 x 40	✓	2,14	--	--	2,57	--	--
	THT06050	Ø6 x 50	✓		2,47	3,17		2,96	3,80
	THT06060	Ø6 x 60	✓		--	--		--	--
THP	THP05040	Ø5 x 40	✓*	2,14	--	--	2,57	--	--
	THP05060	Ø5 x 60	✓*		2,47	3,26		2,96	3,90
	THP06040	Ø6 x 40	✓	2,14	--	--	2,57	--	--
	THP06050	Ø6 x 50	✓		2,47	3,17		2,96	3,80
	THP06060	Ø6 x 60	✓		--	--		--	--
	THP06080	Ø6 x 80	✓		--	--		--	--
THP06100	Ø6 x 100	✓	--	--	--	--			

*Ø5 Approuvé uniquement pour un emploi sur le béton et sur dalles alvéolaires préfabriquées pour des systèmes non-structuraux redondants

8. DOCUMENTATION OFFICIELLE

Par l'intermédiaire de notre service commercial ou de notre site web www.indexfix.com, vous pouvez obtenir les documents suivants :

- Evaluation européen ETA 20/0046 pour l'installation dans du béton non fissuré selon le guide EAD 330232-01-0601, option 1, de Ø6 à Ø18.
- Evaluation européen ETA 20/0494 pour l'installation dans le béton et sur dalles alvéolaires préfabriquées selon le guide EAD 330747-00-0601, option 1, de Ø5 à Ø6.
- Déclaration of performance DoP THE.
- Certificat VdS CEA 4001 :2021-01(07) *Guidelines for sprinklers systems. Planning and installation for applications of water extinguishing systems on concrete elements* de Ø8 à Ø18
- Disponible pour le programme de calcul des ancrs INDEXcal.