

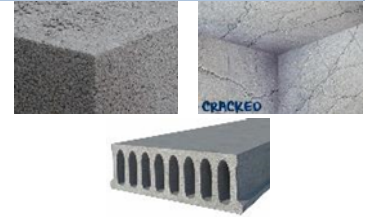

## CARACTÉRISTIQUES

- Un avant-trou est nécessaire ; le filetage du matériau de support s'effectue durant l'installation de l'ancrage.
- Utilisable pour des charges hautes. Haute résistance au feu.
- Apte pour 2 profondeurs d'installation et même 3 avec le Ø10.
- Fixations structurales dans le béton fissuré et non fissuré.
- Se conformer au guide VdS CEA 4001 :2021-01(07) "Guidelines for sprinklers systems. Planning and installation"
- Conçu pour le béton fissuré et non fissuré.
- Utiliser pour les charges statiques ou quasi-statiques.
- Installation facile.
- Installation directe à travers le trou de la plaque d'ancrage.
- Réutilisable
- Peut se démonter, en laissant la surface diaphane.
- Variété de longueurs et métriques, flexibilité dans l'assemblage
- VdS disponible de Ø6 à Ø18
- Disponible en INDEXcal

## MATÉRIAU BASE



## GAMME DE MESURES

Ø5 - Ø18

## CONDITIONNEMENT DU TROU

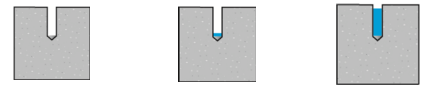

SEC

HUMIDE

INONDÉ

**CHARGES MAXIMALES RECOMMANDÉES  
À LA TRACTION DANS LE BÉTON NON-  
FISSURE [kg]**

## APPLICATION

- Fixations structurales en béton fissuré et non fissuré
- Vitrages, fenêtres et vitrines.
- Étagères et racks
- Installation de balustrades et rampes en intérieurs
- Fixation de structures en bois dans béton

## EVALUATIONS





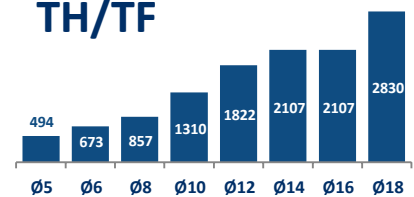



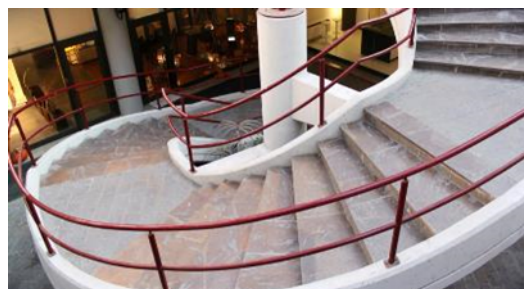







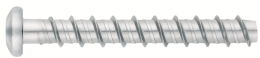

TH/TF



## EXEMPLES D'APPLICATION



1. GAMME						
ITEM	CODE	SIZES	PHOTO	DESCRIPTION	MATÉRIAU	COUVRANT
1	TFE	Ø5 - Ø18		Tête hexagonale à collerette	Acier au carbone estampé, zingué ≥ 5 µm	
2	TFA	Ø5 - Ø10		Fraisée, creux hexalobulaire	Acier au carbone estampé, zingué ≥ 5 µm	
3	TFT	Ø6		Tête bombée, empreinte hexalobulaire	Acier au carbone estampé, zingué ≥ 5 µm	
4	TFP	Ø5 - Ø8		Tête ronde, empreinte hexalobulaire	Acier au carbone estampé, zingué ≥ 5 µm	
5	TFN	Ø14		Tête hexagonale	Acier au carbone estampé, zingué ≥ 5 µm	
6	TFF	Ø5 - Ø8		Filetage femelle (fixation de tiges)	Acier au carbone estampé, zingué ≥ 5 µm	
7	TFM	Ø6		Filetage mâle	Acier au carbone estampé, zingué ≥ 5 µm	
8	TFS	Ø6 - Ø10		Tête filetée	Acier au carbone estampé, zingué ≥ 5 µm	

2. DONNÉES D'INSTALLATION

2.1. PLAN D'INSTALLATION

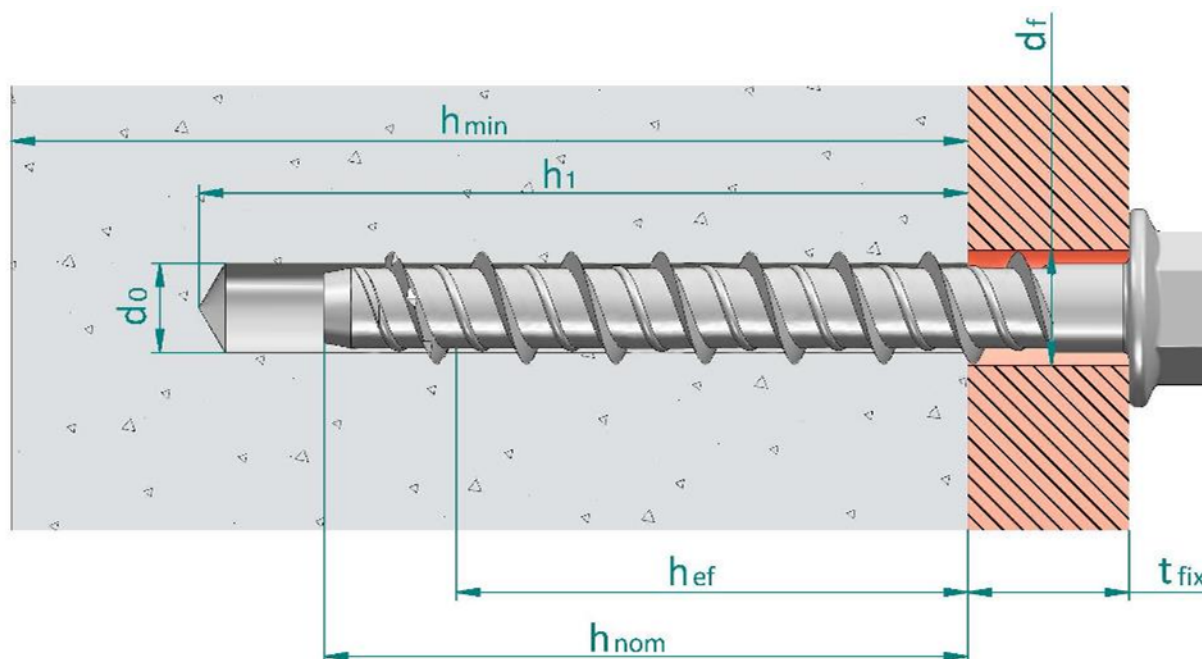

- $d_0$ : Diamètre du foret
- $d_b$ : Épaisseur du fond de la dalle
- $d_f$ : Diamètre du trou d'épaisseur à fixer
- $h_{ef}$ : Profondeur effective
- $h_1$ : Profondeur du trou foré
- $h_{nom}$ : Profondeur d'installation
- $h_{min}$ : Epaisseur minimale du béton
- $t_{fix}$ : Épaisseur à fixer

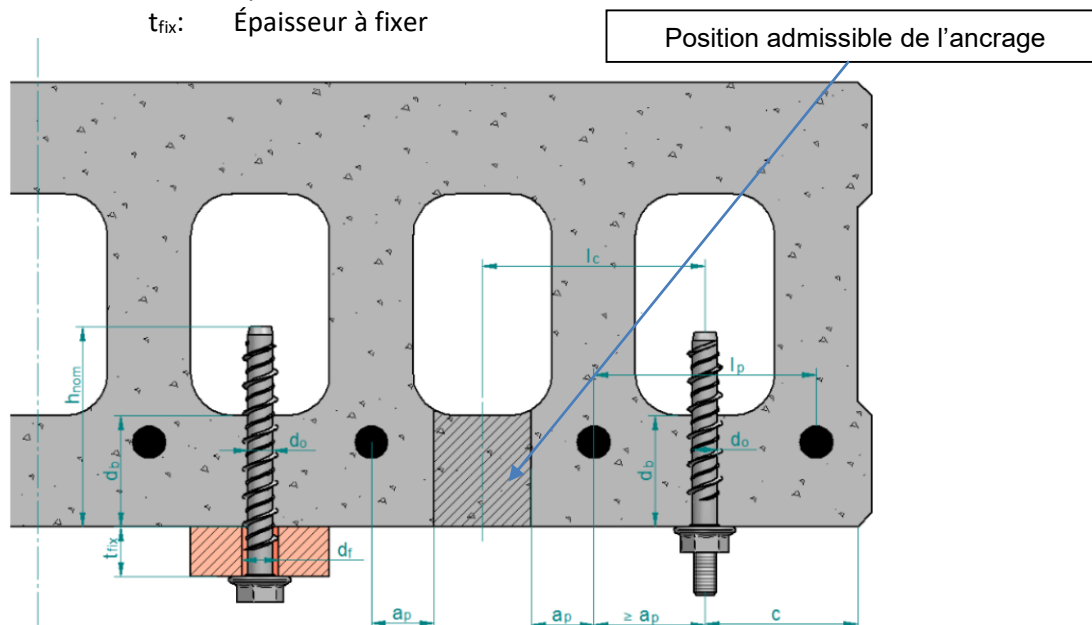

2.2. ÉVALUATION DE CHARGES SISMIQUES

Famille	Code	Dimension (Lettre)	Evaluation	C1	C2	Famille	Code	Dimension (Lettre)	Evaluation	C1	C2
[--]	[--]	[--]	ETA	[--]	[--]	[--]	[--]	[--]	ETA	[--]	[--]
TFE	TFE05040	Ø5 x 40 (A)	✓*	--	--	TFA	TFA05040	Ø5 x 40 (A)	✓*	--	--
	TFE05050	Ø5 x 50 (A)	✓*	--	--		TFA05060	Ø5 x 60 (B)	✓*	--	--
	TFE05060	Ø5 x 60 (B)	✓*	--	--		TFA05080	Ø5 x 80 (D)	✓*	--	--
	TFE05080	Ø5 x 80 (D)	✓*	--	--		TFA05100	Ø5 x 100 (E)	✓*	--	--
	TFE05100	Ø5 x 100 (E)	✓*	--	--		TFA06045	Ø6 x 45	✓	--	--
	TFE06035	Ø6 x 35	✓	--	--		TFA06050	Ø6 x 50	✓	--	--
	TFE06040	Ø6 x 40	✓	--	--		TFA06060	Ø6 x 60	✓	✓	--
	TFE06045	Ø6 x 45	✓	--	--		TFA06080	Ø6 x 80	✓	✓	--
	TFE06050	Ø6 x 50	✓	--	--		TFA06100	Ø6 x 100	✓	✓	--
	TFE06060	Ø6 x 60	✓	✓	--		TFA06120	Ø6 x 120	✓	✓	--
	TFE06070	Ø6 x 70	✓	✓	--		TFA06140	Ø6 x 140	✓	✓	--
	TFE06080	Ø6 x 80	✓	✓	--		TFA08060	Ø8 x 60	✓	✓	✓
	TFE06100	Ø6 x 100	✓	✓	--		TFA08080	Ø8 x 80	✓	✓	✓
	TFE06120	Ø6 x 120	✓	✓	--		TFA08100	Ø8 x 100	✓	✓	✓
	TFE08055	Ø8 x 55	✓	✓	✓		TFA08120	Ø8 x 120	✓	✓	✓
	TFE08060	Ø8 x 60	✓	✓	✓		TFA10100	Ø10 x 100	✓	✓	✓
	TFE08070	Ø8 x 70	✓	✓	✓		TFA10120	Ø10 x 120	✓	✓	✓
	TFE08075	Ø8 x 75	✓	✓	✓		TFT06040	Ø6 x 40	✓	--	--
	TFE08080	Ø8 x 80	✓	✓	✓		TFT06050	Ø6 x 50	✓	--	--
	TFE08090	Ø8 x 90	✓	✓	✓		TFT06060	Ø6 x 60	✓	✓	--
	TFE08100	Ø8 x 100	✓	✓	✓	TFP	TFP05040	Ø5 x 40 (A)	✓*	--	--
	TFE08110	Ø8 x 110	✓	✓	✓		TFP05060	Ø5 x 60 (B)	✓*	--	--
	TFE08120	Ø8 x 120	✓	✓	✓		TFP06040	Ø6 x 40	✓	--	--
	TFE08140	Ø8 x 140	✓	✓	✓		TFP06050	Ø6 x 50	✓	--	--
	TFE10060	Ø10 x 60	✓	--	--		TFP06060	Ø6 x 60	✓	✓	--
	TFE10070	Ø10 x 70	✓	--	--		TFP06080	Ø6 x 80	✓	✓	--
	TFE10080	Ø10 x 80	✓	--	--		TFP06100	Ø6 x 100	✓	✓	--
	TFE10090	Ø10 x 90	✓	✓	✓		TFP08060	Ø8 x 60	✓	✓	✓
	TFE10100	Ø10 x 100	✓	✓	✓		TFP08080	Ø8 x 80	✓	✓	✓
	TFE10120	Ø10 x 120	✓	✓	✓		TFF	TFF05035S	Ø5 x 35 (M6)	✓*	--
	TFE10140	Ø10 x 140	✓	✓	✓	TFF06035		Ø6 x 35 (M8-M10)	✓	--	--
	TFE10160	Ø10 x 160	✓	✓	✓	TFF06040		Ø6 x 40 (M8-M10)	✓	--	--
	TFE10180	Ø10 x 180	✓	✓	✓	TFF06055		Ø6 x 55 (M8-M10)	✓	--	--
	TFE12080	Ø12 x 80	✓	--	--	TFF08050T		Ø8 x 50 (M10)	✓	--	--
	TFE12090	Ø12 x 90	✓	--	--	TFF08050W		Ø8 x 50 (M12)	✓	--	--
	TFE12100	Ø12 x 100	✓	--	--	TFM	TFM06035	Ø6 x 35 (M8)	✓	--	--
	TFE12110	Ø12 x 110	✓	✓	✓		TFM06055	Ø6 x 55 (M10)	✓	--	--
	TFE12130	Ø12 x 130	✓	✓	✓	TFN	TFN14080	Ø14 x 80	✓	--	--
	TFE12150	Ø12 x 150	✓	✓	✓		TFS	TFS06100	Ø6 x 100 (M8)	✓	✓
	TFE14080	Ø14 x 80	✓	--	--	TFS06120		Ø6 x 120 (M8)	✓	✓	--
TFE14100	Ø14 x 100	✓	--	--	TFS08110	Ø8 x 110 (M10)		✓	✓	✓	
TFE14110	Ø14 x 110	✓	--	--	TFS08130	Ø8 x 130 (M10)		✓	✓	✓	
TFE14120	Ø14 x 120	✓	✓	✓	TFS10120	Ø10 x 120 (M12)		✓	--	--	
TFE14130	Ø14 x 130	✓	✓	✓	TFS10140	Ø10 x 140 (M12)		✓	--	--	
TFE14140	Ø14 x 140	✓	✓	✓							
TFE14160	Ø14 x 160	✓	✓	✓							
TFE16100	Ø16 x 100	✓	--	--							
TFE16150	Ø16 x 150	✓	--	--							
TFE18100	Ø18 x 100	✓	--	--							
TFE18130	Ø18 x 130	✓	--	--							
TFE18160	Ø18 x 160	✓	✓	✓							
TFE18180	Ø18 x 180	✓	✓	✓							
TFE18200	Ø18 x 200	✓	✓	✓							

## 3. PARAMETRES D'INSTALLATION (BÉTON)

Paramètres généraux d'installation				Profondeur d'installation standard ( $h_{ef, std}$ )												Profondeur d'installation réduite ( $h_{ef, red}$ )													
Famille	Code	Dimension (Lettre)	Evaluation	Diamètre du foret	Diamètre du trou d'épaisseur à fixer	Version du tête	Couple de serrage maximal	Distance minimale entre axes	Distance minimale au bord	Épaisseur minimale du béton	Profondeur du trou foré	Profondeur d'installation	Profondeur effective	Épaisseur à fixer	Distance minimale entre axes (cône)	Distance critique au bord (cône)	Distance minimale entre axes (fissuration)	Distance critique au bord (fissuration)	Épaisseur minimale du béton	Profondeur du trou foré	Profondeur d'installation	Profondeur effective	Épaisseur à fixer	Distance minimale entre axes (cône)	Distance critique au bord (cône)	Distance minimale entre axes (fissuration)	Distance critique au bord (fissuration)		
[--]	[--]	[--]	ETA	$d_0$ [mm]	$d_f$ [mm]	SW/Tx [--]	$T_{inst}$ [Nm]	$S_{min}$ [mm]	$C_{min}$ [mm]	$h_{min}$ [mm]	$h_1$ [mm]	$h_{nom}$ [mm]	$h_{ef}$ [mm]	$t_{fix}$ [mm]	$S_{cr,N}$ [mm]	$C_{cr,N}$ [mm]	$S_{cr,sp}$ [mm]	$C_{cr,sp}$ [mm]	$h_{min}$ [mm]	$h_1$ [mm]	$h_{nom}$ [mm]	$h_{ef}$ [mm]	$t_{fix}$ [mm]	$S_{cr,N}$ [mm]	$C_{cr,N}$ [mm]	$S_{cr,sp}$ [mm]	$C_{cr,sp}$ [mm]		
TFE	TFE05040	Ø5 x 40(A)	✓*	5	6,5 - 8	SW 8	8	35	35	--	--	--	--	--	--	--	--	--	80	45	35	26,5	5	80	40	80	40		
	TFE05050	Ø5 x 50(A)	✓*			SW 8				5	105	53	105	53	15														
	TFE05060	Ø5 x 60(B)	✓*			SW 8				15	105	53	105	53	35														
	TFE05080	Ø5 x 80(D)	✓*			SW 8				35	105	53	105	53	45														
	TFE05100	Ø5 x 100(E)	✓*			SW 8				55	105	53	105	53	65														
	TFE06035	Ø6 x 35	✓	6	7,5 - 9	SW 10	10	35	35	--	--	--	--	--	--	--	--	--	--	100	45	35	26,0	--	80	39	90	45	
	TFE06040	Ø6 x 40	✓			SW 10				5	129	65	170	85	10														
	TFE06045	Ø6 x 45	✓			SW 10				10	129	65	170	85	15														
	TFE06050	Ø6 x 50	✓			SW 10				15	129	65	170	85	25														
	TFE06060	Ø6 x 60	✓			SW 10				35	129	65	170	85	35														
	TFE06070	Ø6 x 70	✓			SW 10				45	129	65	170	85	45														
	TFE06080	Ø6 x 80	✓			SW 10				65	129	65	170	85	65														
	TFE06100	Ø6 x 100	✓			SW 10				85	129	65	170	85	85														
	TFE06120	Ø6 x 120	✓			SW 10				100	129	65	170	85	100														
	TFE08055	Ø8 x 55	✓			8				10,5 - 12	SW 13	20	35	35	--	--	--	--	--					--					--
	TFE08060	Ø8 x 60	✓	SW 13	10		152	76	200		100				20														
	TFE08070	Ø8 x 70	✓	SW 13	20		152	76	200		100				25														
	TFE08075	Ø8 x 75	✓	SW 13	25		152	76	200		100				30														
	TFE08080	Ø8 x 80	✓	SW 13	35		152	76	200		100				40														
	TFE08090	Ø8 x 90	✓	SW 13	45		152	76	200		100				50														
	TFE08100	Ø8 x 100	✓	SW 13	60		152	76	200		100				70														
	TFE08110	Ø8 x 110	✓	SW 13	70		152	76	200		100				80														
	TFE08120	Ø8 x 120	✓	SW 13	85		152	76	200		100				100														
	TFE08140	Ø8 x 140	✓	SW 13	100		152	76	200		100				120														

\*Ø5 Approuvé uniquement pour un emploi sur le béton et sur dalles alvéolaires préfabriquées pour des systèmes non-structuraux redondants

Paramètres généraux d'installation										Profondeur d'installation standard ( $h_{ef, std}$ )								Profondeur d'installation réduite ( $h_{ef, red}$ )										
Famille	Code	Dimension (Lettre)	Evaluation	Diamètre du foret	Diamètre du trou d'épaisseur à fixer	Version du tête	Couple de serrage maximal	Distance minimale entre axes	Distance minimale au bord	Épaisseur minimale du béton	Profondeur du trou foré	Profondeur d'installation	Profondeur effective	Épaisseur à fixer	Distance minimale entre axes (cône)	Distance critique au bord (cône)	Distance minimale entre axes (fissuration)	Distance critique au bord (fissuration)	Épaisseur minimale du béton	Profondeur du trou foré	Profondeur d'installation	Profondeur effective	Épaisseur à fixer	Distance minimale entre axes (cône)	Distance critique au bord (cône)	Distance minimale entre axes (fissuration)	Distance critique au bord (fissuration)	
[--]	[--]	[--]	ETA	$d_o$	$d_f$	SW/Tx	$T_{inst}$	$S_{min}$	$C_{min}$	$h_{min}$	$h_1$	$h_{nom}$	$h_{ef}$	$t_{fix}$	$S_{cr,N}$	$C_{cr,N}$	$S_{cr,sp}$	$C_{cr,sp}$	$h_{min}$	$h_1$	$h_{nom}$	$h_{ef}$	$t_{fix}$	$S_{cr,N}$	$C_{cr,N}$	$S_{cr,sp}$	$C_{cr,sp}$	
				[mm]	[mm]	[--]	[Nm]	[mm]	[mm]	[mm]	[mm]	[mm]	[mm]	[mm]	[mm]	[mm]	[mm]	[mm]	[mm]	[mm]	[mm]	[mm]	[mm]	[mm]	[mm]	[mm]	[mm]	[mm]
TFE	TFE10060	Ø10 x 60	✓	10	12,5 - 14	SW 15	30	50	40	--	--	--	--	--	--	--	--	--	100	65	55	41,5	5	125	63	140	70	
	TFE10070	Ø10 x 70	✓			15																						
	TFE10080	Ø10 x 80	✓			25																						
	TFE10090	Ø10 x 90	✓			35																						
	TFE10100	Ø10 x 100	✓			5																						
	TFE10120	Ø10 x 120	✓			15																						
	TFE10140	Ø10 x 140	✓			35																						
	TFE10160	Ø10 x 160	✓			55																						
	TFE10180	Ø10 x 180	✓			75																						
	TFE12080	Ø12 x 80	✓	12	14,8 - 16	SW 18	50	75	45	--	--	--	--	--	--	--	--	--	120	90	75	58,0	5	174	87	190	95	
	TFE12090	Ø12 x 90	✓			15																						
	TFE12100	Ø12 x 100	✓			25																						
	TFE12110	Ø12 x 110	✓			35																						
	TFE12130	Ø12 x 130	✓			5																						
	TFE12150	Ø12 x 150	✓			25																						
	TFE14080	Ø14 x 80	✓	14	16,9 - 18	SW 21	70	80	50	--	--	--	--	--	--	--	--	--	120	90	75	58,0	5	174	87	190	95	
	TFE14100	Ø14 x 100	✓			25																						
	TFE14110	Ø14 x 110	✓			35																						
	TFE14120	Ø14 x 120	✓			5																						
	TFE14130	Ø14 x 130	✓			15																						
	TFE14140	Ø14 x 140	✓			25																						
	TFE14160	Ø14 x 160	✓			45																						
	TFE16100	Ø16 x 100	✓	16	18,9 - 20	SW24	80	80	50	--	--	--	--	--	--	--	--	--	115	100	80	58	20	174	87	180	90	
	TFE16150	Ø16 x 150	✓			70																						
TFE18100	Ø18 x 100	✓	18	20,9 - 22	SW 24	90	90	55	--	--	--	--	--	--	--	--	--	140	110	90	69,5	10	209	105	230	115		
TFE18130	Ø18 x 130	✓			40																							
TFE18160	Ø18 x 160	✓			20																							
TFE18180	Ø18 x 180	✓			40																							
TFE18200	Ø18 x 200	✓			60																							

Paramètres généraux d'installation				Profondeur d'installation standard ( $h_{ef, std}$ )														Profondeur d'installation réduite ( $h_{ef, red}$ )														
Famille	Code	Dimension (Lettre)	Evaluation	Diamètre du foret	Diamètre du trou d'épaisseur à fixer	Version du tête	Couple de serrage maximal	Distance minimale entre axes	Distance minimale au bord	Épaisseur minimale du béton	Profondeur du trou foré	Profondeur d'installation	Profondeur effective	Épaisseur à fixer	Distance minimale entre axes (cône)	Distance critique au bord (cône)	Distance minimale entre axes (fissuration)	Distance critique au bord (fissuration)	Épaisseur minimale du béton	Profondeur du trou foré	Profondeur d'installation	Profondeur effective	Épaisseur à fixer	Distance minimale entre axes (cône)	Distance critique au bord (cône)	Distance minimale entre axes (fissuration)	Distance critique au bord (fissuration)					
[--]	[--]	[--]	ETA	$d_0$	$d_f$	SW/Tx	$T_{inst}$	$S_{min}$	$C_{min}$	$h_{min}$	$h_1$	$h_{nom}$	$h_{ef}$	$t_{fix}$	$S_{cr,N}$	$C_{cr,N}$	$S_{cr,sp}$	$C_{cr,sp}$	$h_{min}$	$h_1$	$h_{nom}$	$h_{ef}$	$t_{fix}$	$S_{cr,N}$	$C_{cr,N}$	$S_{cr,sp}$	$C_{cr,sp}$					
				[mm]	[mm]	[--]	[Nm]	[mm]	[mm]	[mm]	[mm]	[mm]	[mm]	[mm]	[mm]	[mm]	[mm]	[mm]	[mm]	[mm]	[mm]	[mm]	[mm]	[mm]	[mm]	[mm]	[mm]	[mm]				
TFA	TFA05040	Ø5 x 40(A)	✓*	5	6,5 - 8	TX25	8	35	35	80	55	45	35,0	--	--	--	--	--	105	53	105	53	80	45	35	26,5	5	80	40	80	40	
	TFA05060	Ø5 x 60(B)	✓*			25																										
	TFA05080	Ø5 x 80(D)	✓*			45																										
	TFA05100	Ø5 x 100(E)	✓*			65																										
	TFA06045	Ø6 x 45	✓	6	7,5 - 9	TX30	10	35	35	--	--	--	--	--	--	--	--	--	--	100	45	35	26,0	10	78	39	90	45	78	39	90	45
	TFA06050	Ø6 x 50	✓			15																										
	TFA06060	Ø6 x 60	✓			25																										
	TFA06080	Ø6 x 80	✓			45																										
	TFA06100	Ø6 x 100	✓			65																										
	TFA06120	Ø6 x 120	✓			85																										
	TFA06140	Ø6 x 140	✓			105																										
	TFA08060	Ø8 x 60	✓			8				10,5 - 12	TX45	20	35	35	--	--	--	--	--					--								
	TFA08080	Ø8 x 80	✓	30																												
	TFA08100	Ø8 x 100	✓	50																												
TFA08120	Ø8 x 120	✓	70																													
TFA10100	Ø10 x 100	✓	10	12,5 - 14	TX50	30	50	40	135	95	85	67,0	15	201	101	210	105	100	65	55	41,5	45	125	63	140	70	125	63	140	70		
TFA10120	Ø10 x 120	✓			65																											
TFT	TFT06040	Ø6 x 40	✓	6	7,5 - 9	TX30	10	35	35	--	--	--	--	--	--	--	--	--	100	45	35	26,0	5	78	39	90	45	78	39	90	45	
	TFT06050	Ø6 x 50	✓			15																										
	TFT06060	Ø6 x 60	✓			25																										
TFP	TFP05040	Ø5 x 40(A)	✓*	5	6,5 - 8	TX30	8	35	35	--	--	--	--	--	--	--	--	--	80	45	35	26,5	5	80	40	80	40	80	40			
	TFP05060	Ø5 x 60(B)	✓*			25																										
	TFP06040	Ø6 x 40	✓	6	7,5 - 9	TX40	10	35	35	--	--	--	--	--	--	--	--	--	100	45	35	26,0	5	78	39	90	45	78	39	90	45	
	TFP06050	Ø6 x 50	✓			15																										
	TFP06060	Ø6 x 60	✓			25																										
	TFP06080	Ø6 x 80	✓			45																										
	TFP06100	Ø6 x 100	✓			65																										
TFP08060	Ø8 x 60	✓	8	10,5 - 12	TX45	20	35	35	--	--	--	--	--	--	--	--	--	100	60	50	37,5	10	113	57	130	65	113	57	130	65		
TFP08080	Ø8 x 80	✓			30																											
TFN	TFN14080	Ø14 x 80	✓	14	16,9 - 18	SW 24	70	80	50	--	--	--	--	--	--	--	--	--	120	90	75	58,0	5	174	87	190	95	174	87	190	95	

\*Ø5 Approuvé uniquement pour un emploi sur le béton et sur dalles alvéolaires préfabriquées pour des systèmes non-structuraux redondants

Paramètres généraux d'installation										Profondeur d'installation standard ( $h_{ef, std}$ )								Profondeur d'installation réduite ( $h_{ef, red}$ )									
Famille	Code	Dimension (Lettre)	Evaluation	Diamètre du foret	Diamètre du trou d'épaisseur à fixer	Version du tête	Couple de serrage maximal	Distance minimale entre axes	Distance minimale au bord	Épaisseur minimale du béton	Profondeur du trou foré	Profondeur d'installation	Profondeur effective	Épaisseur à fixer	Distance minimale entre axes (cône)	Distance critique au bord (cône)	Distance minimale entre axes (fissuration)	Distance critique au bord (fissuration)	Épaisseur minimale du béton	Profondeur du trou foré	Profondeur d'installation	Profondeur effective	Épaisseur à fixer	Distance minimale entre axes (cône)	Distance critique au bord (cône)	Distance minimale entre axes (fissuration)	Distance critique au bord (fissuration)
[--]	[--]	[--]	ETA	$d_o$ [mm]	$d_f$ [mm]	SW/Tx [--]	$T_{inst}$ [Nm]	$S_{min}$ [mm]	$C_{min}$ [mm]	$h_{min}$ [mm]	$h_1$ [mm]	$h_{nom}$ [mm]	$h_{ef}$ [mm]	$t_{fix}$ [mm]	$S_{cr,N}$ [mm]	$C_{cr,N}$ [mm]	$S_{cr,sp}$ [mm]	$C_{cr,sp}$ [mm]	$h_{min}$ [mm]	$h_1$ [mm]	$h_{nom}$ [mm]	$h_{ef}$ [mm]	$t_{fix}$ [mm]	$S_{cr,N}$ [mm]	$C_{cr,N}$ [mm]	$S_{cr,sp}$ [mm]	$C_{cr,sp}$ [mm]
TFF	TFF05035S	Ø5 x 35 (M6)	✓*	5	--	SW10	8	35	35	--	--	--	--	--	--	--	--	--	80	45	35	26,5	--	80	40	80	40
	TFF06035	Ø6 x 35 (M8-M10)	✓	6	--	SW 13	10	35	35	--	--	--	--	--	--	--	--	--	100	45	35	26,0	--	78	39	90	45
	TFF06040	Ø6 x 40 (M8-M10)	✓			SW 13				--	--	--	--	--	100	45	35	26,0	--	78	39	90	45				
	TFF06055	Ø6 x 55 (M8-M10)	✓			SW 13				100	65	55	43,0	--	129	65	170	85	--	--	--	--	--				
	TFF08050T	Ø8 x 50 (M10)	✓	8	--	SW 13	20	35	35	--	--	--	--	--	--	--	--	--	100	60	50	37,5	--	113	57	130	65
	TFF08050W	Ø8 x 50 (M12)	✓			SW 17				--	--	--	--	--	100	60	50	37,5	--	113	57	130	65				
TFM	TFM06035	Ø6 x 35 (M8)	✓	6	--	SW 13	10	35	35	--	--	--	--	--	--	--	--	--	100	65	55	26,0	--	78	39	90	45
	TFM06055	Ø6 x 55 (M10)	✓			SW 13				100	65	55	43,0	--	129	65	170	85	--	--	--	--	--				
TFS	TFS06100	Ø6 x 100 (M8)	✓	6	7,5 - 9	SW 5	10	35	35	100	65	55	43,0	35	129	65	170	85	100	45	35	26,0	55	78	39	90	45
	TFS06120	Ø6 x 120 (M8)	✓			SW 5								55									75				
	TFS08110	Ø8 x 110 (M10)	✓	8	10,5 - 12	SW 7	20	35	35	100	75	65	50,5	29	152	76	200	100	100	60	50	37,5	47	113	57	130	65
	TFS08130	Ø8 x 130 (M10)	✓			SW 7								49									75				
	TFS10120	Ø10 x 120 (M12)	✓	10	12,5 - 14	SW 8	30	50	40	120	85	75	58,5	27	176	88	190	95	100	65	55	41,5	52	125	63	140	70
	TFS10140	Ø10 x 140 (M12)	✓			SW 8								47									75				

\*Ø5 Approuvé uniquement pour un emploi sur le béton et sur dalles alvéolaires préfabriquées pour des systèmes non-structuraux redondants



4. PARAMETRES D'INSTALLATION (DALLE ALVÉOLAIRE) [Profondeur d'installation réduite /intermédiaire/standard]

Paramètres généraux d'installation				Profondeur d'installation (h <sub>ef1</sub> / h <sub>ef2</sub> / h <sub>ef3</sub> )														
Famille	Code	Dimension (Lettre)	Evaluation	Diamètre du foret	Diamètre du trou d'épaisseur à fixer	Version du tête	Couple de serrage maximal	Distance minimale entre axes	Distance minimale au bord	Épaisseur du fond de la dalle	Profondeur du trou foré	Profondeur d' installation	Profondeur effective	Épaisseur à fixer	Distance minimale entre axes (cône)	Distance critique au bord (cône)	Distance minimale entre axes (fissuration)	Distance critique au bord (fissuration)
[--]	[--]	[--]	ETA	d <sub>0</sub> [mm]	d <sub>f</sub> [mm]	SW/Tx [--]	T <sub>inst</sub> [Nm]	S <sub>min</sub> [mm]	C <sub>min</sub> [mm]	d <sub>b</sub> [mm]	h <sub>1</sub> [mm]	h <sub>nom</sub> [mm]	h <sub>ef</sub> [mm]	t <sub>fix</sub> [mm]	S <sub>cr,N</sub> [mm]	C <sub>cr,N</sub> [mm]	S <sub>cr,sp</sub> [mm]	C <sub>cr,sp</sub> [mm]
TFE	TFE05040	Ø5 x 40(A)	✓*	5	6,5 - 8	SW 8	8	35	35	25/30/40	30/40/45	30/40/45	20/22/26,5	10/--/--	60/66/80	30/33/40	80	80
	TFE05050	Ø5 x 50(A)	✓*			20/10/5												
	TFE05060	Ø5 x 60(B)	✓*			30/20/15												
	TFE05080	Ø5 x 80(D)	✓*			50/40/35												
	TFE05100	Ø5 x 100(E)	✓*			70/60/55												
	TFE06035	Ø6 x 35	✓	6	7,5 - 9	SW 10	10	35	35	25/30/40	30/40/45	30/40/45	20/22/26	5/--/--	60/66/78	30/33/39	90	45
	TFE06040	Ø6 x 40	✓			10/--/--												
	TFE06045	Ø6 x 45	✓			15/5/--												
	TFE06050	Ø6 x 50	✓			20/10/5												
	TFE06060	Ø6 x 60	✓			30/20/15												
	TFE06070	Ø6 x 70	✓			40/30/25												
	TFE06080	Ø6 x 80	✓			50/40/35												
	TFE06100	Ø6 x 100	✓			70/60/55												
	TFE06120	Ø6 x 120	✓			90/80/75												
TFE06140	Ø6 x 140	✓																
TFA	TFA05040	Ø5 x 40(A)	✓*	5	6,5 - 8	TX25	8	35	35	25/30/40	30/40/45	30/40/45	20/22/26,5	10/--/--	60/66/80	30/33/40	80	80
	TFA05060	Ø5 x 60(B)	✓*			30/20/15												
	TFA05080	Ø5 x 80(D)	✓*			50/40/35												
	TFA05100	Ø5 x 100(E)	✓*			70/60/55												
	TFA06045	Ø6 x 45	✓	6	7,5 - 9	TX30	10	35	35	25/30/40	30/40/45	30/40/45	20/22/26	15/5/--	60/66/78	30/33/39	90	45
	TFA06050	Ø6 x 50	✓			20/10/5												
	TFA06060	Ø6 x 60	✓			30/20/15												
	TFA06080	Ø6 x 80	✓			50/40/35												
	TFA06100	Ø6 x 100	✓			70/60/55												
	TFA06120	Ø6 x 120	✓			90/80/75												
	TFA06140	Ø6 x 140	✓			110/100/95												

\*Ø5 Approuvé uniquement pour un emploi sur le béton et sur dalles alvéolaires préfabriquées pour des systèmes non-structuraux redondants

Paramètres généraux d'installation										Profondeur d'installation ( $h_{ef1}$ / $h_{ef2}$ / $h_{ef3}$ )								
Famille	Code	Dimension (Lettre)	Evaluation	Diamètre du foret	Diamètre du trou d'épaisseur à fixer	Version du tête	Couple de serrage maximal	Distance minimale entre axes	Distance minimale au bord	Épaisseur du fond de la dalle	Profondeur du trou foré	Profondeur d'installation	Profondeur effective	Épaisseur à fixer	Distance minimale entre axes (cône)	Distance critique au bord (cône)	Distance minimale entre axes (fissuration)	Distance critique au bord (fissuration)
[--]	[--]	[--]	ETA	$d_0$	$d_f$	SW/Tx	$T_{inst}$	$S_{min}$	$C_{min}$	$d_b$	$h_1$	$h_{nom}$	$h_{ef}$	$t_{fix}$	$S_{cr,N}$	$C_{cr,N}$	$S_{cr,sp}$	$C_{cr,sp}$
				[mm]	[mm]	[--]	[Nm]	[mm]	[mm]	[mm]	[mm]	[mm]	[mm]	[mm]	[mm]	[mm]	[mm]	[mm]
TFT	TFT06040	Ø6 x 40	✓	6	7,5 - 9	TX30	10	35	35	25/30/40	30/40/45	30/40/45	20/22/26	10/--/--	60/66/78	30/33/39	90	45
	TFT06050	Ø6 x 50	✓			TX30								20/10/5				
	TFT06060	Ø6 x 60	✓			TX30								30/20/15				
TFP	TFP05040	Ø5 x 40(A)	✓*	5	6,5 - 8	TX30	8	35	35	25/30/40	30/40/45	30/40/45	20/22/26,5	10/--/--	60/66/80	30/33/40	80	80
	TFP05060	Ø5 x 60(B)	✓*			TX30								30/20/15				
	TFP06040	Ø6 x 40	✓	6	7,5 - 9	TX40	10	35	35	25/30/40	30/40/45	30/40/45	20/22/26	10/--/--	60/66/78	30/33/39	90	45
	TFP06050	Ø6 x 50	✓			TX40								20/10/5				
	TFP06060	Ø6 x 60	✓			TX40								30/20/15				
	TFP06080	Ø6 x 80	✓			TX40								50/40/35				
	TFP06100	Ø6 x 100	✓			TX40								70/60/55				
TFF	TFF05035S	Ø5 x 35 (M6)	✓*	5	6,5 - 8	SW10	8	35	35	25/30/40	30/40/45	30/40/45	20/22/26	--/--/--	60/66/80	30/33/40	80	80
	TFF06035	Ø6 x 35 (M8-M10)	✓	6	7,5 - 9	SW 13	10	35	35	25/30/40	30/40/45	30/40/45	20/22/26	--/--/--	60/66/78	30/33/39	90	45
	TFF06040	Ø6 x 40 (M8-M10)	✓															
	TFF06055	Ø6 x 55 (M8-M10)	✓															
TFM	TFM06035	Ø6 x 35 (M8)	✓	6	7,5 - 9	SW 13	10	35	35	25/30/40	30/40/45	30/40/45	20/22/26	--/--/--	60/66/78	30/33/39	90	45
	TFM06055	Ø6 x 55 (M10)	✓															
TFS	TFS06100	Ø6 x 100 (M8)	✓	6	7,5 - 9	SW 5	10	35	35	25/30/40	30/40/45	30/40/45	20/22/26	56/46/41	60/66/78	30/33/39	90	45
	TFS06120	Ø6 x 120 (M8)	✓											76/66/61				

\*Ø5 Approuvé uniquement pour un emploi sur le béton et sur dalles alvéolaires préfabriquées pour des systèmes non-structuraux redondants

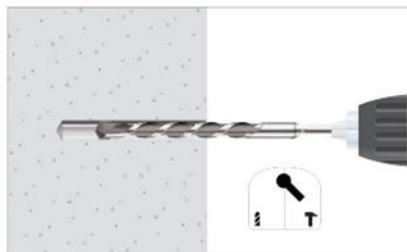
**5. PROCESSUS D'INSTALLATION****5.1. INSTALLATION DANS LE BÉTON ET DALLE ALVÉOLAIRE****1. PERCER**

Vérifier que le béton est bien compact et sans pores significatifs.

Admet des trous secs, humides ou inondés.

Perçage en mode percussion ou marteau.

Percer au diamètre et à la profondeur spécifiée.

**2. SOUFLER ET NETTOYER**

Nettoyer le trou des restes de poussière et des fragments du perçage.

Utiliser bombe d'air et brosse

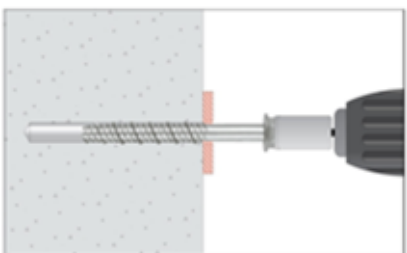
**3. INSTALLER**

Utiliser une clé à choc ou une clé dynamométrique ne dépassant pas les couples de serrage maximaux Timpact,max ou Tins,max respectivement.

Connecter la douille d'installation ou la pointe hexagonal.

Assembler la tête de la vis dans la douille/pointe.

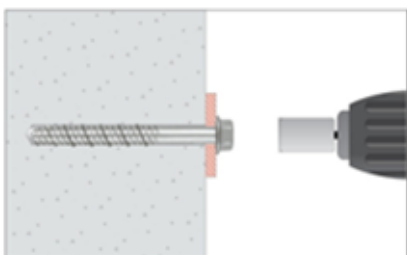
**4. APPLIQUER COUPLE DE SERRAGE**

Insérer la vis dans le trou avec une clé à choc ou une clé dynamométrique à travers la plaque d'ancrage jusqu'à ce que la tête soit en contact avec la plaque. La vis doit rester serrée après l'installation et ne doit plus être desserrée.

## 6. RÉSISTANCES (BÉTON)

Les résistances dans le béton C20 / 25 pour un ancrage isolé sans effets de la distance au bord et des distances entre les ancrages sont indiquées dans le tableau suivant :

Les valeurs *soulignées et en italique* indiquent une défaillance de l'acier, les valeurs en **gras** indiquent une défaillance par le béton et le reste indique une défaillance par extraction.

1 KN ≈ 100 kg

### 6.1 RESISTANCES CHARACTERISTIQUES (APPLICATION STRUCTURELLE) [kN]

Paramètres généraux				Béton non-fissuré				Béton fissuré											
Famille	Code	Dimension	Evaluation ETA	Traction $N_{Rk, ucr}$		Cisaillement $V_{Rk, ucr}$		Traction $N_{Rk, ucr}$		Cisaillement $V_{Rk, ucr}$									
				( $h_{ef, std}$ )	( $h_{ef, red}$ )	( $h_{ef, std}$ )	( $h_{ef, red}$ )	( $h_{ef, std}$ )	( $h_{ef, red}$ )	( $h_{ef, std}$ )	( $h_{ef, red}$ )								
TFE	TFE05040	Ø5 x 40	✓*	--	<b>6,71</b>	--	<b>6,71</b>	--	<b>4,70</b>	--	<b>4,70</b>								
	TFE05050	Ø5 x 50	✓*	<b>10,19</b>	<b>6,71</b>	<u><i>8,19</i></u>	<b>6,71</b>	<b>7,13</b>	<b>4,70</b>	<b>7,13</b>	<b>4,70</b>								
	TFE05060	Ø5 x 60	✓*																
	TFE05080	Ø5 x 80	✓*																
	TFE05100	Ø5 x 100	✓*																
	TFE06035	Ø6 x 35	✓	--	<b>5,00</b>	--	<u><i>12,53</i></u>	--	<b>4,57</b>	--	<b>9,36</b>								
	TFE06040	Ø6 x 40	✓																
	TFE06045	Ø6 x 45	✓																
	TFE06050	Ø6 x 50	✓																
	TFE06060	Ø6 x 60	✓	<b>13,87</b>	<b>5,00</b>	<u><i>12,53</i></u>	<u><i>12,53</i></u>	<b>9,71</b>	<b>4,57</b>	<b>11,17</b>	<b>9,36</b>								
	TFE06070	Ø6 x 70	✓																
	TFE06080	Ø6 x 80	✓																
	TFE06100	Ø6 x 100	✓																
	TFE06120	Ø6 x 120	✓																
	TFE08055	Ø8 x 55	✓									--	<b>11,30</b>	--	<u><i>19,57</i></u>	--	<b>7,91</b>	--	<b>14,23</b>
	TFE08060	Ø8 x 60	✓																
	TFE08070	Ø8 x 70	✓	<b>17,65</b>	<b>11,30</b>	<u><i>19,57</i></u>	<u><i>19,57</i></u>	<b>12,36</b>	<b>7,91</b>	<b>15,69</b>	<b>14,23</b>								
	TFE08075	Ø8 x 75	✓																
	TFE08080	Ø8 x 80	✓																
	TFE08090	Ø8 x 90	✓																
	TFE08100	Ø8 x 100	✓																
	TFE08110	Ø8 x 110	✓																
	TFE08120	Ø8 x 120	✓																
	TFE08140	Ø8 x 140	✓																
	TFE10060	Ø10 x 60	✓	--	<b>13,15</b>	--	<b>25,65</b>	--	<b>9,21</b>	--	<b>17,95</b>								
	TFE10070	Ø10 x 70	✓																
	TFE10080	Ø10 x 80	✓																
	TFE10090	Ø10 x 90	✓																
	TFE10100	Ø10 x 100	✓																
	TFE10120	Ø10 x 120	✓																
	TFE10140	Ø10 x 140	✓																
	TFE10160	Ø10 x 160	✓	<b>26,98</b>	<b>13,15</b>	<u><i>27,40</i></u>	<b>25,65</b>	<b>18,89</b>	<b>9,21</b>	<u><i>27,40</i></u>	<b>17,95</b>								
TFE10180	Ø10 x 180	✓																	
TFE12080	Ø12 x 80	✓																	
TFE12090	Ø12 x 90	✓																	
TFE12100	Ø12 x 100	✓	--	<b>21,73</b>	--	<u><i>37,24</i></u>	--	<b>15,21</b>	--	<b>35,44</b>									
TFE12110	Ø12 x 110	✓																	
TFE12130	Ø12 x 130	✓	<b>37,54</b>	<b>21,73</b>	<u><i>37,24</i></u>	<u><i>37,24</i></u>	<b>26,27</b>	<b>15,21</b>	<u><i>37,24</i></u>	<b>35,44</b>									
TFE12150	Ø12 x 150	✓																	
TFE14080	Ø14 x 80	✓	--	<b>21,73</b>	--	<u><i>52,72</i></u>	--	<b>15,21</b>	--	<b>38,79</b>									
TFE14100	Ø14 x 100	✓																	
TFE14110	Ø14 x 110	✓																	
TFE14120	Ø14 x 120	✓																	
TFE14130	Ø14 x 130	✓	<b>43,41</b>	<b>21,73</b>	<u><i>52,72</i></u>	<u><i>52,72</i></u>	<b>30,39</b>	<b>15,21</b>	<u><i>52,72</i></u>	<b>38,79</b>									
TFE14140	Ø14 x 140	✓																	
TFE14160	Ø14 x 160	✓																	
TFE16100	Ø16 x 100	✓									--	<b>21,73</b>	--	<b>46,50</b>	<b>30,39</b>	<b>15,21</b>	<u><i>52,72</i></u>	<b>32,55</b>	
TFE16150	Ø16 x 150	✓																	
TFE18100	Ø18 x 100	✓	--	<b>28,50</b>	--	<b>75,82</b>	--	<b>19,95</b>	--	<b>53,07</b>									
TFE18130	Ø18 x 130	✓																	
TFE18160	Ø18 x 160	✓	<b>58,31</b>	<b>28,50</b>	<u><i>80,78</i></u>	<b>75,82</b>	<b>40,82</b>	<b>19,95</b>	<u><i>80,78</i></u>	<b>53,07</b>									
TFE18180	Ø18 x 180	✓																	
TFE18200	Ø18 x 200	✓																	

Paramètres généraux				Béton non-fissuré				Béton fissuré			
Famille	Code	Dimension	Evaluation ETA	Traction $N_{Rk, ucr}$		Cisaillement $V_{Rk, ucr}$		Traction $N_{Rk, ucr}$		Cisaillement $V_{Rk, ucr}$	
				( $h_{ef, std}$ )	( $h_{ef, red}$ )	( $h_{ef, std}$ )	( $h_{ef, red}$ )	( $h_{ef, std}$ )	( $h_{ef, red}$ )	( $h_{ef, std}$ )	( $h_{ef, red}$ )
TFA	TFA05040	Ø5 x 40	✓*	--	6,71	--	6,71	--	4,70	--	4,70
	TFA05060	Ø5 x 60	✓*	10,19	6,71	<u>8,19</u>	6,71	7,13	4,70	7,13	4,70
	TFA05080	Ø5 x 80	✓*								
	TFA05100	Ø5 x 100	✓*								
	TFA06045	Ø6 x 45	✓	--	5,00	--	<u>12,53</u>	--	4,57	--	9,36
	TFA06050	Ø6 x 50	✓	--		--		--			
	TFA06060	Ø6 x 60	✓	13,87	5,00	<u>12,53</u>	<u>12,53</u>	9,71	4,57	11,17	9,36
	TFA06080	Ø6 x 80	✓								
	TFA06100	Ø6 x 100	✓								
	TFA06120	Ø6 x 120	✓								
	TFA06140	Ø6 x 140	✓								
	TFA08060	Ø8 x 60	✓	--	11,30	--	<u>19,57</u>	--	7,91	--	14,23
	TFA08080	Ø8 x 80	✓	17,65	11,30	<u>19,57</u>	<u>19,57</u>	12,36	7,91	15,69	14,23
	TFA08100	Ø8 x 100	✓								
TFA08120	Ø8 x 120	✓									
TFA10100	Ø10 x 100	✓	26,98	13,15	<u>27,40</u>	25,65	18,89	9,21	<u>27,40</u>	17,95	
TFA10120	Ø10 x 120	✓									
TFT	TFT06040	Ø6 x 40	✓	--	5,00	--	<u>12,53</u>	--	4,57	--	9,36
	TFT06050	Ø6 x 50	✓	--		--		--			
	TFT06060	Ø6 x 60	✓	13,87	5,00	<u>12,53</u>	<u>12,53</u>	9,71	4,57	11,17	9,36
TFP	TFP05040	Ø5 x 40	✓*	--	6,71	--	6,71	--	4,70	--	4,70
	TFP05060	Ø5 x 60	✓*	10,19	6,71	<u>8,19</u>	6,71	7,13	4,70	7,13	4,70
	TFP06040	Ø6 x 40	✓	--	5,00	--	<u>12,53</u>	9,71	4,57	--	9,36
	TFP06050	Ø6 x 50	✓	--		--				--	
	TFP06060	Ø6 x 60	✓	13,87	5,00	<u>12,53</u>	<u>12,53</u>	9,71	4,57	11,17	9,36
	TFP06080	Ø6 x 80	✓								
	TFP06100	Ø6 x 100	✓								
	TFP08060	Ø8 x 60	✓	--	11,30	--	<u>19,57</u>	--	7,91	--	14,23
TFP08080	Ø8 x 80	✓	17,65	11,30	<u>19,57</u>	<u>19,57</u>	12,36	7,91	15,69	14,23	
TFN	TFN14080	Ø14 x 80	✓	--	21,73	--	<u>52,72</u>	--	15,21	--	38,79
TFF	TFF05035S	Ø5 x 35 (M6)	✓*	--	6,71	--	--	--	4,70	--	--
	TFF06035	Ø6 x 35 (M8-M10)	✓	--	5,00	--	--	--	4,57	--	--
	TFF06040	Ø6 x 40 (M8-M10)	✓	--		--	--	--			
	TFF06055	Ø6 x 55 (M8-M10)	✓	13,87	--	--	--	9,71	--	--	--
	TFF08050T	Ø8 x 50 (M10)	✓	--	11,30	--	--	--	7,91	--	--
	TFF08050W	Ø8 x 50 (M12)	✓	--		--	--	--			
TFM	TFM06035	Ø6 x 35 (M8)	✓	--	5,00	--	--	--	4,57	--	--
	TFM06055	Ø6 x 55 (M10)	✓	13,87	--	--	--	9,71	--	--	--
TFS	TFS06100	Ø6 x 100 (M8)	✓	13,87	5,00	<u>12,53</u>	<u>12,53</u>	9,71	4,57	11,17	9,36
	TFS06120	Ø6 x 120 (M8)	✓								
	TFS08110	Ø8 x 110 (M10)	✓	17,65	11,30	<u>19,57</u>	<u>19,57</u>	12,36	7,91	15,69	14,23
	TFS08130	Ø8 x 130 (M10)	✓								
	TFS10120	Ø10 x 120 (M12)	✓								
	TFS10140	Ø10 x 140 (M12)	✓	22,01	13,15	<u>27,40</u>	25,65	15,41	9,21	20,34	17,95

\*Ø5 Approuvé uniquement pour un emploi sur le béton et sur dalles alvéolaires préfabriquées pour des systèmes non-structuraux redondants

6.2 RESISTANCES DE CALCUL (APPLICATION STRUCTURELLE) [kN]

Paramètres généraux				Béton non-fissuré				Béton fissuré			
Familie	Code	Dimension	Evaluation ETA	Traction $N_{Rd,ucr}$		Cisaillement $V_{Rd,ucr}$		Traction $N_{Rd,cr}$		Cisaillement $V_{Rd,cr}$	
				( $h_{ef,sta}$ )	( $h_{ef,red}$ )	( $h_{ef,sta}$ )	( $h_{ef,red}$ )	( $h_{ef,sta}$ )	( $h_{ef,red}$ )	( $h_{ef,sta}$ )	( $h_{ef,red}$ )
TFE	TFE05040	Ø5 x 40	✓*	--	4,47	--	4,47	--	3,13	--	3,13
	TFE05050	Ø5 x 50	✓*	6,79	4,47	<u>5,46</u>	4,47	4,75	3,13	4,75	3,13
	TFE05060	Ø5 x 60	✓*								
	TFE05080	Ø5 x 80	✓*								
	TFE05100	Ø5 x 100	✓*								
	TFE06035	Ø6 x 35	✓	--	2,78	--	<u>8,35</u>	--	2,54	--	6,24
	TFE06040	Ø6 x 40	✓	--		--		--			
	TFE06045	Ø6 x 45	✓	--		--		--			
	TFE06050	Ø6 x 50	✓	--		--		--			
	TFE06060	Ø6 x 60	✓	9,25	2,78	<u>8,35</u>	<u>8,35</u>	6,47	2,54	7,44	6,24
	TFE06070	Ø6 x 70	✓								
	TFE06080	Ø6 x 80	✓								
	TFE06100	Ø6 x 100	✓								
	TFE06120	Ø6 x 120	✓	11,77	6,28	<u>13,05</u>	<u>13,05</u>	8,24	4,39	10,46	9,49
	TFE08055	Ø8 x 55	✓								
	TFE08060	Ø8 x 60	✓								
	TFE08070	Ø8 x 70	✓								
	TFE08075	Ø8 x 75	✓								
	TFE08080	Ø8 x 80	✓								
	TFE08090	Ø8 x 90	✓								
	TFE08100	Ø8 x 100	✓								
	TFE08110	Ø8 x 110	✓	--	8,77	--	17,10	--	6,14	--	11,97
	TFE10060	Ø10 x 60	✓								
	TFE10070	Ø10 x 70	✓								
	TFE10080	Ø10 x 80	✓								
	TFE10090	Ø10 x 90	✓	17,99	8,77	<u>18,27</u>	17,10	12,59	6,14	<u>18,27</u>	11,97
	TFE10100	Ø10 x 100	✓								
	TFE10120	Ø10 x 120	✓								
	TFE10140	Ø10 x 140	✓								
	TFE10160	Ø10 x 160	✓								
	TFE10180	Ø10 x 180	✓								
	TFE12080	Ø12 x 80	✓	--	14,49	--	<u>24,83</u>	--	10,14	--	23,63
TFE12090	Ø12 x 90	✓									
TFE12100	Ø12 x 100	✓									
TFE12110	Ø12 x 110	✓	25,02	14,49	<u>24,83</u>	<u>24,83</u>	17,52	10,14	<u>24,83</u>	23,63	
TFE12130	Ø12 x 130	✓									
TFE12150	Ø12 x 150	✓									
TFE14080	Ø14 x 80	✓	--	21,73	--	<u>52,72</u>	--	15,21	--	38,79	
TFE14100	Ø14 x 100	✓									
TFE14110	Ø14 x 110	✓									
TFE14120	Ø14 x 120	✓	43,41	21,73	<u>52,72</u>	<u>52,72</u>	30,39	15,21	<u>52,72</u>	38,79	
TFE14130	Ø14 x 130	✓									
TFE14140	Ø14 x 140	✓									
TFE14160	Ø14 x 160	✓									
TFE16100	Ø16 x 100	✓	--	--	--	--	20,26	10,14	<u>38,65</u>	21,70	
TFE16150	Ø16 x 150	✓	28,94	14,49	<u>38,65</u>	31,00	--	13,30	--	35,38	
TFE18100	Ø18 x 100	✓	--	19,00	--	50,54					
TFE18130	Ø18 x 130	✓	--	--	--	--					
TFE18160	Ø18 x 160	✓	38,87	19,00	<u>53,85</u>	50,54	27,21	13,30	<u>53,85</u>	35,38	
TFE18180	Ø18 x 180	✓									
TFE18200	Ø18 x 200	✓									

Paramètres généraux				Béton non-fissuré				Béton fissuré			
Famille	Code	Dimension	Evaluation ETA	Traction $N_{Rd,ucr}$		Cisaillement $V_{Rd,ucr}$		Traction $N_{Rd,cr}$		Cisaillement $V_{Rd,cr}$	
				( $h_{ef,sta}$ )	( $h_{ef,red}$ )	( $h_{ef,sta}$ )	( $h_{ef,red}$ )	( $h_{ef,sta}$ )	( $h_{ef,red}$ )	( $h_{ef,sta}$ )	( $h_{ef,red}$ )
TFA	TFA05040	Ø5 x 40	✓*	--	4,47	--	4,47	--	3,13	--	3,13
	TFA05060	Ø5 x 60	✓*	6,79	4,47	5,46	4,47	4,75	3,13	4,75	3,13
	TFA05080	Ø5 x 80	✓*								
	TFA05100	Ø5 x 100	✓*								
	TFA06045	Ø6 x 45	✓	--	2,78	--	8,35	--	2,54	--	6,24
	TFA06050	Ø6 x 50	✓	--		--		--			
	TFA06060	Ø6 x 60	✓	9,25	2,78	8,35	8,35	6,47	2,54	7,44	6,24
	TFA06080	Ø6 x 80	✓								
	TFA06100	Ø6 x 100	✓								
	TFA06120	Ø6 x 120	✓								
	TFA06140	Ø6 x 140	✓								
	TFA08060	Ø8 x 60	✓	--	6,28	--	13,05	--	4,39	--	9,49
	TFA08080	Ø8 x 80	✓	11,77	6,28	13,05	13,05	8,24	4,39	10,46	9,49
	TFA08100	Ø8 x 100	✓								
TFA08120	Ø8 x 120	✓									
TFA10100	Ø10 x 100	✓	17,99	8,77	18,27	17,10	12,59	6,14	18,27	11,97	
TFA10120	Ø10 x 120	✓									
TFT	TFT06040	Ø6 x 40	✓	--	2,78	--	8,35	--	2,54	--	6,24
	TFT06050	Ø6 x 50	✓	--		--		--			
	TFT06060	Ø6 x 60	✓	9,25	2,78	8,35	8,35	6,47	2,54	7,44	6,24
	TFT08060	Ø8 x 60	✓	--	6,28	--	13,05	--	4,39	--	9,49
TFP	TFP05040	Ø5 x 40	✓*	--	4,47	--	4,47	--	3,13	--	3,13
	TFP05060	Ø5 x 60	✓*	6,79	4,47	5,46	4,47	4,75	3,13	4,75	3,13
	TFP06040	Ø6 x 40	✓	--	2,78	--	8,35	--	2,54	--	6,24
	TFP06050	Ø6 x 50	✓	--		--		--			
	TFP06060	Ø6 x 60	✓	9,25	2,78	8,35	8,35	6,47	2,54	7,44	6,24
	TFP06080	Ø6 x 80	✓								
	TFP06100	Ø6 x 100	✓								
	TFP08060	Ø8 x 60	✓	--	6,28	--	13,05	--	4,39	--	9,49
TFP08080	Ø8 x 80	✓	11,77	6,28	13,05	13,05	8,24	4,39	10,46	9,49	
TFN	TFN14080	Ø14 x 80	✓	--	14,49	--	35,15	--	10,14	--	25,86
TFF	TFF05035S	Ø5 x 35 (M6)	✓*	--	4,47	--	--	--	3,13	--	--
	TFF06035	Ø6 x 35 (M8-M10)	✓	--	2,78	--	--	--	2,54	--	--
	TFF06040	Ø6 x 40 (M8-M10)	✓	--		--	--				
	TFF06055	Ø6 x 55 (M8-M10)	✓	9,25	--	--	--	6,47	--	--	--
	TFF08050T	Ø8 x 50 (M10)	✓	--	6,28	--	--	--	4,39	--	--
	TFF08050W	Ø8 x 50 (M12)	✓	--		--	--				
TFM	TFM06035	Ø6 x 35 (M8)	✓	--	2,78	--	--	--	2,54	--	--
	TFM06055	Ø6 x 55 (M10)	✓	9,25	--	--	--	6,47	--	--	--
TFS	TFS06100	Ø6 x 100 (M8)	✓	9,25	2,78	8,35	8,35	6,47	2,54	7,44	6,24
	TFS06120	Ø6 x 120 (M8)	✓								
	TFS08110	Ø8 x 110 (M10)	✓	11,77	6,28	13,05	13,05	8,24	4,39	10,46	9,49
	TFS08130	Ø8 x 130 (M10)	✓								
	TFS10120	Ø10 x 120 (M12)	✓								
	TFS10140	Ø10 x 140 (M12)	✓	14,67	8,77	18,27	17,10	10,27	6,14	13,56	11,97

\*Ø5 Approuvé uniquement pour un emploi sur le béton et sur dalles alvéolaires préfabriquées pour des systèmes non-structuraux redondants

**6.3 CHARGES MAXIMALES RECOMMANDÉES (APPLICATION STRUCTURELLE) [kN] (avec  $\gamma_F= 1.4$ )**

Paramètres généraux				Béton non-fissuré				Béton fissuré							
Familie	Code	Dimension	Evaluation ETA	Traction $N_{rec, ucr}$		Cisaillement $V_{rec, ucr}$		Traction $N_{rec, cr}$		Cisaillement $V_{rec, cr}$					
				( $h_{ef, std}$ )	( $h_{ef, red}$ )	( $h_{ef, std}$ )	( $h_{ef, red}$ )	( $h_{ef, std}$ )	( $h_{ef, red}$ )	( $h_{ef, std}$ )	( $h_{ef, red}$ )				
TFE	TFE05040	Ø5 x 40	✓*	--	3,20	--	3,20	--	2,24	--	2,24				
	TFE05050	Ø5 x 50	✓*	4,85	3,20	<u>3,90</u>	3,20	3,40	2,24	3,40	2,24				
	TFE05060	Ø5 x 60	✓*												
	TFE05080	Ø5 x 80	✓*												
	TFE05100	Ø5 x 100	✓*												
	TFE06035	Ø6 x 35	✓	--	1,98	--	<u>5,97</u>	--	1,81	--	4,46				
	TFE06040	Ø6 x 40	✓	--		--		--							
	TFE06045	Ø6 x 45	✓	--		--		--							
	TFE06050	Ø6 x 50	✓	--		--		--							
	TFE06060	Ø6 x 60	✓	6,61	1,98	<u>5,97</u>	<u>5,97</u>	4,62	1,81	5,32	4,46				
	TFE06070	Ø6 x 70	✓												
	TFE06080	Ø6 x 80	✓												
	TFE06100	Ø6 x 100	✓												
	TFE06120	Ø6 x 120	✓	8,41	4,48	<u>9,32</u>	<u>9,32</u>	5,88	3,14	7,47	6,78				
	TFE08055	Ø8 x 55	✓												
	TFE08060	Ø8 x 60	✓												
	TFE08070	Ø8 x 70	✓												
	TFE08075	Ø8 x 75	✓	8,41	4,48	<u>9,32</u>	<u>9,32</u>	5,88	3,14	7,47	6,78				
	TFE08080	Ø8 x 80	✓												
	TFE08090	Ø8 x 90	✓												
	TFE08100	Ø8 x 100	✓												
	TFE08110	Ø8 x 110	✓	8,41	4,48	<u>9,32</u>	<u>9,32</u>	5,88	3,14	7,47	6,78				
	TFE08120	Ø8 x 120	✓												
	TFE08140	Ø8 x 140	✓												
	TFE10060	Ø10 x 60	✓												
	TFE10070	Ø10 x 70	✓	--	6,26	--	12,21	--	4,38	--	8,55				
	TFE10080	Ø10 x 80	✓	--		--		--							
	TFE10090	Ø10 x 90	✓	12,85		6,26		<u>13,05</u>		12,21		8,99	4,38	<u>13,05</u>	8,55
	TFE10100	Ø10 x 100	✓												
	TFE10120	Ø10 x 120	✓												
	TFE10140	Ø10 x 140	✓												
	TFE10160	Ø10 x 160	✓	12,85	6,26	<u>13,05</u>	12,21	8,99	4,38	<u>13,05</u>	8,55				
TFE10180	Ø10 x 180	✓													
TFE12080	Ø12 x 80	✓													
TFE12090	Ø12 x 90	✓													
TFE12090	Ø12 x 90	✓	--	10,35	--	<u>17,73</u>	--	7,24	--	16,88					
TFE12100	Ø12 x 100	✓	--		--		--								
TFE12110	Ø12 x 110	✓	17,87		10,35		<u>17,73</u>		<u>17,73</u>		12,51	7,24	<u>17,73</u>	16,88	
TFE12130	Ø12 x 130	✓													
TFE12150	Ø12 x 150	✓													
TFE14080	Ø14 x 80	✓													
TFE14100	Ø14 x 100	✓	--	10,35	--	<u>25,10</u>	--	7,24	--	18,47					
TFE14110	Ø14 x 110	✓	--		--		--								
TFE14120	Ø14 x 120	✓	20,67		10,35		<u>25,10</u>		<u>25,10</u>		14,47	7,24	<u>25,10</u>	18,47	
TFE14130	Ø14 x 130	✓													
TFE14140	Ø14 x 140	✓													
TFE14160	Ø14 x 160	✓													
TFE16100	Ø16 x 100	✓	--	--	--	--	14,47	7,24	<u>27,60</u>	15,50					
TFE16150	Ø16 x 150	✓	20,67	10,35	<u>27,60</u>	22,14									
TFE18100	Ø18 x 100	✓	--	13,57	--	36,10	--	9,50	--	25,27					
TFE18130	Ø18 x 130	✓	--		--		--								
TFE18160	Ø18 x 160	✓	27,77		13,57		<u>38,47</u>		36,10		19,44	9,50	<u>38,47</u>	25,27	
TFE18180	Ø18 x 180	✓													
TFE18200	Ø18 x 200	✓	--	--	--	--	--	--	--	--					



Paramètres généraux				Béton non-fissuré				Béton fissuré			
Familie	Code	Dimension	Evaluation ETA	Traction $N_{rec,ucr}$		Cisaillement $V_{rec,ucr}$		Traction $N_{rec,cr}$		Cisaillement $V_{rec,cr}$	
				( $h_{ef, std}$ )	( $h_{ef, red}$ )	( $h_{ef, std}$ )	( $h_{ef, red}$ )	( $h_{ef, std}$ )	( $h_{ef, red}$ )	( $h_{ef, std}$ )	( $h_{ef, red}$ )
TFA	TFA05040	Ø5 x 40	✓*	--	3,20	--	3,20	--	2,24	--	2,24
	TFA05060	Ø5 x 60	✓*	4,85	3,20	3,90	3,20	3,40	2,24	3,40	2,24
	TFA05080	Ø5 x 80	✓*								
	TFA05100	Ø5 x 100	✓*								
	TFA06045	Ø6 x 45	✓	--	1,98	--	5,97	--	1,81	--	4,46
	TFA06050	Ø6 x 50	✓	--		--		--			
	TFA06060	Ø6 x 60	✓	6,61	1,98	5,97	5,97	4,62	1,81	5,32	4,46
	TFA06080	Ø6 x 80	✓								
	TFA06100	Ø6 x 100	✓								
	TFA06120	Ø6 x 120	✓								
	TFA06140	Ø6 x 140	✓	8,41	4,48	9,32	9,32	5,88	3,14	7,47	6,78
	TFA08060	Ø8 x 60	✓								
	TFA08080	Ø8 x 80	✓								
	TFA08100	Ø8 x 100	✓								
TFA08120	Ø8 x 120	✓	12,85	6,26	13,05	12,21	8,99	4,38	13,05	8,55	
TFA10100	Ø10 x 100	✓									
TFA10120	Ø10 x 120	✓									
TFT	TFT06040	Ø6 x 40	✓	--	1,98	--	5,97	--	1,81	--	4,46
	TFT06050	Ø6 x 50	✓	--		--		--			
	TFT06060	Ø6 x 60	✓	6,61	1,98	5,97	5,97	4,62	1,81	5,32	4,46
TFP	TFP05040	Ø5 x 40	✓*	--	3,20	--	3,20	--	2,24	--	2,24
	TFP05060	Ø5 x 60	✓*	4,85	3,20	3,90	3,20	3,40	2,24	3,40	2,24
	TFP06040	Ø6 x 40	✓								
	TFP06050	Ø6 x 50	✓								
	TFP06060	Ø6 x 60	✓	6,61	1,98	5,97	5,97	4,62	1,81	5,32	4,46
	TFP06080	Ø6 x 80	✓								
	TFP06100	Ø6 x 100	✓								
	TFP08060	Ø8 x 60	✓								
TFP08080	Ø8 x 80	✓	8,41	4,48	9,32	9,32	5,88	3,14	7,47	6,78	
TFN	TFN14080	Ø14 x 80	✓	--	10,35	--	25,10	--	7,24	--	18,47
TFF	TFF05035S	Ø5 x 35 (M6)	✓*	--	3,20	--	--	--	2,24	--	--
	TFF06035	Ø6 x 35 (M8-M10)	✓	--	1,98	--	--	--	1,81	--	--
	TFF06040	Ø6 x 40 (M8-M10)	✓								
	TFF06055	Ø6 x 55 (M8-M10)	✓	6,61	--	--	--	4,62	--	--	--
	TFF08050T	Ø8 x 50 (M10)	✓	--	4,48	--	9,32	--	3,14	--	--
	TFF08050W	Ø8 x 50 (M12)	✓								
TFM	TFM06035	Ø6 x 35 (M8)	✓	--	1,98	--	--	--	1,81	--	--
	TFM06055	Ø6 x 55 (M10)	✓	6,61	--	--	--	4,62	--	--	--
TFS	TFS06100	Ø6 x 100 (M8)	✓	6,61	1,98	5,97	5,97	4,62	1,81	5,32	4,46
	TFS06120	Ø6 x 120 (M8)	✓								
	TFS08110	Ø8 x 110 (M10)	✓	8,41	4,48	9,32	9,32	5,88	3,14	7,47	6,78
	TFS08130	Ø8 x 130 (M10)	✓								
	TFS10120	Ø10 x 120 (M12)	✓								
	TFS10140	Ø10 x 140 (M12)	✓	10,48	6,26	13,05	12,21	7,34	4,38	9,68	8,55

\*Ø5 Approuvé uniquement pour un emploi sur le béton et sur dalles alvéolaires préfabriquées pour des systèmes non-structuraux redondants

COEFFICIENT DE MAJORATION A EXTRACTION POUR CHARGUES A TRACTION DANS DU BÉTON HAUTE RÉSIDENCE $\psi_c$															
Diamètre	Ø5		Ø6		Ø8		Ø10			Ø12		Ø14		Ø18	
Profondeur d'installation	( $h_{ef, red}$ )	( $h_{ef, std}$ )	( $h_{ef, red}$ )	( $h_{ef, std}$ )	( $h_{ef, red}$ )	( $h_{ef, std}$ )	( $h_{ef, 1}$ )	( $h_{ef, 2}$ )	( $h_{ef, 3}$ )	( $h_{ef, red}$ )	( $h_{ef, std}$ )	( $h_{ef, red}$ )	( $h_{ef, std}$ )	( $h_{ef, red}$ )	( $h_{ef, std}$ )
C30/37	1,00	1,00	1,16	1,22	1,21	1,22	1,22	1,17	1,22	1,16	1,22	1,21	1,20	1,22	1,17
C40/50	1,00	1,00	1,28	1,41	1,39	1,41	1,41	1,30	1,41	1,29	1,41	1,39	1,37	1,40	1,32
C50/60	1,00	1,00	1,39	1,58	1,54	1,58	1,58	1,42	1,58	1,40	1,58	1,55	1,51	1,57	1,42

## 7. RÉSISTANCES (DALLE ALVÉOLAIRE)

Les résistances dans la dalle alvéolaire creux C30/37 pour un ancrage isolé sans effets de la distance au bord et des distances entre les ancrages sont indiquées dans le tableau suivant :

Les valeurs *soulignées et en italique* indiquent une défaillance de l'acier, les valeurs en **gras** indiquent une défaillance par le béton et le reste indique une défaillance par extraction.

1 KN ≈ 100 kg

### 7.1 RESISTANCES CHARACTERISTIQUES (APPLICATION NON STRUCTURELLE) [kN]

Paramètres généraux				Dalle alvéolaire creux											
Famille	Code	Dimension	Evaluation ETA	Traction N <sub>Rk</sub>			Cisaillement V <sub>Rk</sub>								
				(h <sub>ef1</sub> )	(h <sub>ef2</sub> )	(h <sub>ef3</sub> )	(h <sub>ef1</sub> )	(h <sub>ef2</sub> )	(h <sub>ef3</sub> )						
TFE	TFE05040	Ø5 x 40	✓*	5,39	--	--	5,39	--	--						
	TFE05050	Ø5 x 50	✓*		5,39	6,22		8,22	5,39	6,22	<u>8,19</u>				
	TFE05060	Ø5 x 60	✓*			5,39		6,22		7,99	5,39	6,22	7,99		
	TFE05080	Ø5 x 80	✓*					5,39		6,22		7,99	5,39	6,22	7,99
	TFE05100	Ø5 x 100	✓*							5,39		6,22		7,99	5,39
	TFE06035	Ø6 x 35	✓	5,39			6,22					7,99		5,39	
	TFE06040	Ø6 x 40	✓		5,39		6,22		7,99			5,39			
	TFE06045	Ø6 x 45	✓			5,39	6,22		7,99		5,39				
	TFE06050	Ø6 x 50	✓				5,39	6,22	7,99				5,39		
	TFE06060	Ø6 x 60	✓					5,39	6,22	7,99					5,39
	TFE06070	Ø6 x 70	✓	5,39					6,22	7,99				5,39	
	TFE06080	Ø6 x 80	✓		5,39				6,22	7,99		5,39			
	TFE06100	Ø6 x 100	✓			5,39			6,22	7,99	5,39				
TFE06120	Ø6 x 120	✓	5,39				6,22		7,99	5,39			6,22		
TFA	TFA05040	Ø5 x 40					✓*	5,39	--				--		5,39
	TFA05060	Ø5 x 60		✓*			5,39		6,22				8,22	5,39	
	TFA05080	Ø5 x 80		✓*	5,39				6,22			7,99	5,39		
	TFA05100	Ø5 x 100		✓*		5,39			6,22		7,99	5,39			
	TFA06045	Ø6 x 45	✓	5,39					6,22	7,99	5,39				
	TFA06050	Ø6 x 50	✓					5,39	6,22	7,99					5,39
	TFA06060	Ø6 x 60	✓				5,39		6,22	7,99				5,39	
	TFA06080	Ø6 x 80	✓		5,39				6,22	7,99			5,39		
	TFA06100	Ø6 x 100	✓			5,39			6,22	7,99		5,39			
TFA06120	Ø6 x 120	✓	5,39	6,22					7,99	5,39	6,22				
TFA06140	Ø6 x 140	✓		5,39				6,22	7,99		5,39				6,22
THT	TFT06040	Ø6 x 40					✓	5,39	--					--	5,39
	TFT06050	Ø6 x 50			✓		5,39		6,22				7,99	5,39	
	TFT06060	Ø6 x 60			✓	5,39			6,22			7,99	5,39		
THP	TFP05040	Ø5 x 40	✓*		5,39			--	--	5,39		--			--
	TFP05060	Ø5 x 60	✓*	5,39			6,22	8,22	5,39		6,22	<u>8,19</u>			
	TFP06040	Ø6 x 40	✓		5,39	6,22	7,99	5,39		6,22	7,99				
	TFP06050	Ø6 x 50	✓	5,39		6,22	7,99		5,39	6,22	7,99				
	TFP06060	Ø6 x 60	✓			5,39	6,22			7,99	5,39	6,22	7,99		
	TFP06080	Ø6 x 80	✓				5,39			6,22		7,99	5,39	6,22	7,99
TFP06100	Ø6 x 100	✓	5,39		6,22			7,99		5,39		6,22		7,99	
TFF	TFF05035S	Ø5 x 35 (M6)		✓*	5,39			6,22	8,22			5,39		6,22	<u>8,19</u>
	TFF06035	Ø6 x 35 (M8-M10)		✓		5,39		6,22	7,99		5,39			6,22	7,99
	TFF06040	Ø6 x 40 (M8-M10)		✓			5,39	6,22	7,99				5,39	6,22	7,99
	TFF06055	Ø6 x 55 (M8-M10)	✓	5,39				6,22	7,99	5,39				6,22	7,99
TFM	TFM06035	Ø6 x 35 (M8)	✓		5,39			6,22	7,99			5,39		6,22	7,99
	TFM06055	Ø6 x 55 (M10)	✓			5,39		6,22	7,99		5,39			6,22	7,99
TFS	TFS06100	Ø6 x 100 (M8)	✓		5,39		6,22	7,99	5,39			6,22	7,99		
	TFS06120	Ø6 x 120 (M8)	✓	5,39		6,22	7,99	5,39		6,22	7,99				

\*Ø5 Approuvé uniquement pour un emploi sur le béton et sur dalles alvéolaires préfabriquées pour des systèmes non-structuraux redondants

7.2 RESISTANCES DE CALCUL (APPLICATION NON STRUCTURELLE) [kN]									
Paramètres généraux				Dalle alvéolaire creux					
Famille	Code	Dimension	Evaluation ETA	Traction $N_{Rd}$			Cisaillement $V_{Rd}$		
				( $h_{ef1}$ )	( $h_{ef2}$ )	( $h_{ef3}$ )	( $h_{ef1}$ )	( $h_{ef2}$ )	( $h_{ef3}$ )
TFE	TFE05040	Ø5 x 40	✓*	2,99	--	--	3,59	--	--
	TFE05050	Ø5 x 50	✓*		--	--		--	--
	TFE05060	Ø5 x 60	✓*		3,45	4,57		4,14	5,46
	TFE05080	Ø5 x 80	✓*						
	TFE05100	Ø5 x 100	✓*	2,99	--	--	3,59	--	--
	TFE06035	Ø6 x 35	✓		--	--		--	--
	TFE06040	Ø6 x 40	✓		3,45	4,44		4,14	5,33
	TFE06045	Ø6 x 45	✓						
	TFE06050	Ø6 x 50	✓						
	TFE06060	Ø6 x 60	✓						
	TFE06070	Ø6 x 70	✓						
	TFE06080	Ø6 x 80	✓						
	TFE06100	Ø6 x 100	✓						
TFE06120	Ø6 x 120	✓							
TFA	TFA05040	Ø5 x 40	✓*	2,99	--	--	3,59	--	--
	TFA05060	Ø5 x 60	✓*		3,45	4,57		4,14	5,46
	TFA05080	Ø5 x 80	✓*						
	TFA05100	Ø5 x 100	✓*						
	TFA06045	Ø6 x 45	✓	2,99	--	--	3,59	--	--
	TFA06050	Ø6 x 50	✓		3,45	4,44		4,14	5,33
	TFA06060	Ø6 x 60	✓						
	TFA06080	Ø6 x 80	✓						
	TFA06100	Ø6 x 100	✓						
	TFA06120	Ø6 x 120	✓						
THT	TFT06040	Ø6 x 40	✓	2,99	--	--	3,59	--	--
	TFT06050	Ø6 x 50	✓		3,45	4,44		4,14	5,33
	TFT06060	Ø6 x 60	✓						
THP	TFP05040	Ø5 x 40	✓*	2,99	--	--	3,59	--	--
	TFP05060	Ø5 x 60	✓*		3,45	4,57		4,14	5,46
	TFP06040	Ø6 x 40	✓	2,99	--	--	3,59	--	--
	TFP06050	Ø6 x 50	✓		3,45	4,44		4,14	5,33
	TFP06060	Ø6 x 60	✓						
	TFP06080	Ø6 x 80	✓						
	TFP06100	Ø6 x 100	✓						
TFF	TFF05035S	Ø5 x 35 (M6)	✓*	2,99	6,22	8,22	3,59	4,14	5,46
	TFF06035	Ø6 x 35 (M8-M10)	✓	2,99	3,45	4,44	3,59	4,14	5,33
	TFF06040	Ø6 x 40 (M8-M10)	✓						
	TFF06055	Ø6 x 55 (M8-M10)	✓						
TFM	TFM06035	Ø6 x 35 (M8)	✓	2,99	3,45	4,44	3,59	4,14	5,33
	TFM06055	Ø6 x 55 (M10)	✓						
TFS	TFS06100	Ø6 x 100 (M8)	✓	2,99	3,45	4,44	3,59	4,14	5,33
	TFS06120	Ø6 x 120 (M8)	✓						

\*Ø5 Approuvé uniquement pour un emploi sur le béton et sur dalles alvéolaires préfabriquées pour des systèmes non-structuraux redondants

**7.3 CHARGES MAXIMALES RECOMMANDÉES (APPLICATION NON STRUCTURELLE) [kN] (avec  $\gamma_F = 1.4$ )**

Paramètres généraux				Dalle alvéolaire creux					
Famille	Code	Dimension	Evaluation ETA	Traction $N_{rec}$			Cisaillement $V_{rec}$		
				( $h_{ef1}$ )	( $h_{ef2}$ )	( $h_{ef3}$ )	( $h_{ef1}$ )	( $h_{ef2}$ )	( $h_{ef3}$ )
TFE	TFE05040	Ø5 x 40	✓*	2,14	--	--	2,57	--	--
	TFE05050	Ø5 x 50	✓*		--	--		--	--
	TFE05060	Ø5 x 60	✓*		2,47	3,26		2,96	3,90
	TFE05080	Ø5 x 80	✓*						
	TFE05100	Ø5 x 100	✓*	2,14	--	--	2,57	--	--
	TFE06035	Ø6 x 35	✓		--	--		--	--
	TFE06040	Ø6 x 40	✓		2,47	3,17		2,96	3,80
	TFE06045	Ø6 x 45	✓						
	TFE06050	Ø6 x 50	✓						
	TFE06060	Ø6 x 60	✓						
	TFE06070	Ø6 x 70	✓						
	TFE06080	Ø6 x 80	✓						
	TFE06100	Ø6 x 100	✓						
TFE06120	Ø6 x 120	✓							
TFA	TFA05040	Ø5 x 40	✓*	2,14	--	--	2,57	--	--
	TFA05060	Ø5 x 60	✓*		2,47	3,26		2,96	3,90
	TFA05080	Ø5 x 80	✓*						
	TFA05100	Ø5 x 100	✓*						
	TFA06045	Ø6 x 45	✓	2,14	--	--	2,57	--	--
	TFA06050	Ø6 x 50	✓		2,47	3,17		2,96	3,80
	TFA06060	Ø6 x 60	✓						
	TFA06080	Ø6 x 80	✓						
	TFA06100	Ø6 x 100	✓						
	TFA06120	Ø6 x 120	✓						
THT	TFT06040	Ø6 x 40	✓	2,14	--	--	2,57	--	--
	TFT06050	Ø6 x 50	✓		2,47	3,17		2,96	3,80
	TFT06060	Ø6 x 60	✓						
THP	TFP05040	Ø5 x 40	✓*	2,14	--	--	2,57	--	--
	TFP05060	Ø5 x 60	✓*		2,47	3,26		2,96	3,90
	TFP06040	Ø6 x 40	✓	2,14	--	--	2,57	--	--
	TFP06050	Ø6 x 50	✓		2,47	3,17		2,96	3,80
	TFP06060	Ø6 x 60	✓						
	TFP06080	Ø6 x 80	✓						
	TFP06100	Ø6 x 100	✓						
TFF	TFF05035S	Ø5 x 35 (M6)	✓*	2,14	2,47	3,26	2,57	2,96	3,90
	TFF06035	Ø6 x 35 (M8-M10)	✓	2,14	2,47	3,17	2,57	2,96	3,80
	TFF06040	Ø6 x 40 (M8-M10)	✓						
	TFF06055	Ø6 x 55 (M8-M10)	✓						
TFM	TFM06035	Ø6 x 35 (M8)	✓	2,14	2,47	3,17	2,57	2,96	3,80
	TFM06055	Ø6 x 55 (M10)	✓						
TFS	TFS06100	Ø6 x 100 (M8)	✓	2,14	2,47	3,17	2,57	2,96	3,80
	TFS06120	Ø6 x 120 (M8)	✓						

\*Ø5 Approuvé uniquement pour un emploi sur le béton et sur dalles alvéolaires préfabriquées pour des systèmes non-structuraux redondants

## 8. DOCUMENTATION OFFICIELLE

Par l'intermédiaire de notre service commercial ou de notre site web [www.indexfix.com](http://www.indexfix.com), vous pouvez obtenir les documents suivants :

- Evaluation européen ETA 20/0046 pour l'installation dans du béton non fissuré selon le guide EAD 330232-01-0601, option 1, de  $\varnothing 6$  à  $\varnothing 18$ .
- Evaluation européen ETA 20/0494 pour l'installation dans le béton et sur dalles alvéolaires préfabriquées selon le guide EAD 330747-00-0601, option 1, de  $\varnothing 5$  à  $\varnothing 6$ .
- Déclaration of performance DoP THE.
- Certificat VdS CEA 4001 :2021-01(07) *Guidelines for sprinklers systems. Planning and installation for applications of water extinguishing systems on concrete elements* de  $\varnothing 8$  à  $\varnothing 18$
- Disponible pour le programme de calcul des ancrés INDEXcal.