



## CHARACTERISTICS AND APPLICATIONS

- Plugs for fixing of external thermal insulation systems.
- Different lengths (from 70 mm until 300 mm), diameters ( $\varnothing 8$  y  $\varnothing 10$ ) and thicknesses to be fixed.
- Variety of washers for different kinds of insulation.
- Two different materials, steel and polypropylene.
- Quick fixing, through the insulations, hammer installation by hitting the nylon plug and then the nylon or steel nail.
- Screw for fixing on insulation panels avoiding thermal bridges (TE).
- Suitable for a several base materials: concrete, stone, solid bricks, hollow bricks, concrete hollow blocks, etc.
- European Technical Assessment, ETA-21/0823, for use in concrete, aerated concrete, silicate bricks, clay bricks and hollow concrete blocks.
- Valid for fixing of external thermal insulation systems of different types: mineral wool, polystyrenes, glass wool, rock wool, cellulose panels, etc.
- Examples: façade rehabilitation (ETICS) and all kind of façade systems.



## BASE MATERIALS



## APPLICATION EXAMPLES



1. RANGE				
ITEM	CODE	PHOTO	COMPONENT	MATERIAL
1	AIS		Expansion plastic plug monocomponent	Polypropylene
2	AIS-C		Expansion plastic plug	Polypropylene
			Expansion plastic nail	Polyamide 6 reinforced with glass fiber
3	AIS-S		Expansion plastic plug	Polypropylene
			Expansion metal nail	Carbon steel Zinc plated $\geq 5\mu\text{m}$
4	AIS-R		Plastic washer	Polypropylene
5	AIS-W		Plastic washer	Polypropylene
6	AIS-M		Expansion metal plug monocomponent	Carbon steel pregalvanized
7	AIS-AM		Metal washer	Carbon steel Zinc plated $\geq 7\mu\text{m}$
8	TE		Plastic screw	Polyamide 6

## 2. INSTALLATION DATA

### 2.1 AIS / AIS-C / AIS-S / AIS-M



$d_o \times l_t$ : plug dimensions	[mm]
$\varnothing d \times l_v$ : nail dimensions	[mm]
$d_o$ : drillhole diameter / drill bit size	[mm]
$h_{ef} = h_{nom}$ : effective depth = installation depth	[mm]
$h_1$ : drill hole minimum depth	[mm]
$h_{min}$ : minimum thickness of material base	[mm]
$t_{fix}$ : maximum thickness to be fixed	[mm]
$\varnothing D$ : washer diameter	[mm]
$S_{min}$ : minimum spacing between anchors	[mm]
$C_{min}$ : minimum base material edge distance	[mm]

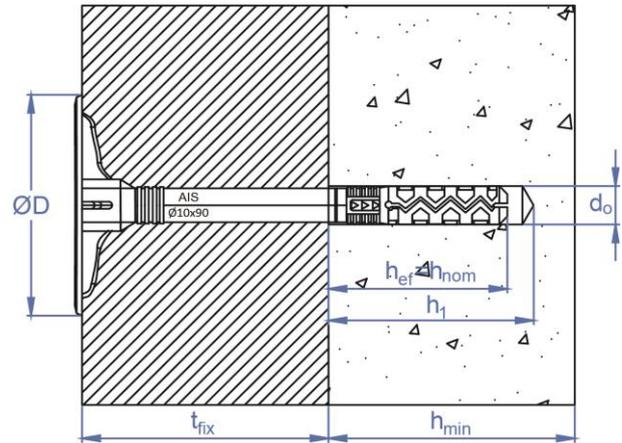

#### Installation data

CODE	ETA	$d_o \times l_t$	$\varnothing d \times l_v$	$d_o$	$h_{ef} = h_{nom}$	$h_1$	$h_{min}$	$t_{fix}$	$\varnothing D$	$S_{min}$	$C_{min}$
		[mm]	[mm]								
AIS08080		8 x 80	--	8	30	30	50	50	34	100	100
AIS08100		8 x 100	--	8				70			
AIS08120		8 x 110	--	8				80			
AIS08140		8 x 130	--	8				100			
AISC10070 / AISS10070	✓	10 x 70	5,7 / 5,5 x 75	10	50	60	100	20	60	100	100
AISC10090 / AISS10090	✓	10 x 90	5,7 / 5,5 x 95	10				40			
AISC10100 / AISS10100	✓	10 x 100	5,7 / 5,5 x 105	10				50			
AISC10120 / AISS10120	✓	10 x 120	5,7 / 5,5 x 125	10				70			
AISC10140 / AISS10140	✓	10 x 140	5,7 / 5,5 x 145	10				90			
AISC10160 / AISS10160	✓	10 x 160	5,7 / 5,5 x 165	10				110			
AISC10180 / AISS10180	✓	10 x 180	5,7 / 5,5 x 185	10				130			
AISC10200 / AISS10200	✓	10 x 200	5,7 / 5,5 x 205	10				150			
AISC10220 / AISS10220	✓	10 x 220	5,7 / 5,5 x 225	10				170			
AISC10260 / AISS10260	✓	10 x 260	5,7 / 5,5 x 265	10				210			
AISM08090		8 x 90	--	8				40			
AISM08110		8 x 110	--	8	70						
AISM08120		8 x 120	--	8	80						
AISM08140		8 x 140	--	8	100						
AISM08170		8 x 170	--	8	130						
AISM08200		8 x 200	--	8	160						
AISM08250		8 x 250	--	8	210						
AISM08300		8 x 300	--	8	260						

2.2 AIS-R / AIS-W / AIS-AM / TE



Installation data

CODE	$\varnothing D$	$\varnothing d$	L	Valid for
	[mm]	[mm]	[mm]	[--]
AISR140	$\varnothing 140$	11	--	AIS-C / AIS-S
AISW060	$\varnothing 60$	6	--	TPPO/TEX $\varnothing 5-6$
AISAM085	$\varnothing 85$	9	--	AIS-M
TE25050	25	--	50	Válido para
TE25090		--	90	[--]

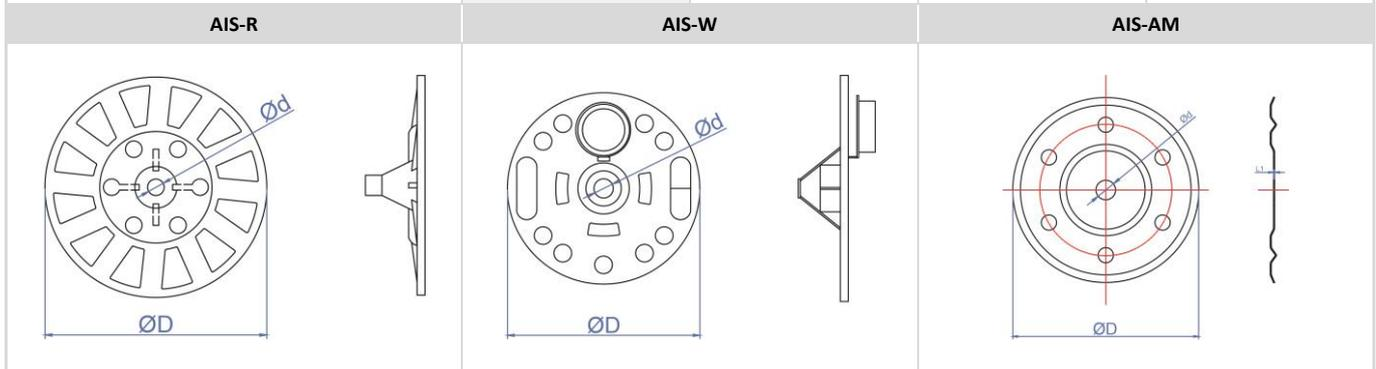

2.3 TE

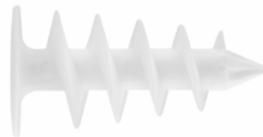

Installation data

CODE	$\varnothing D$	L	Valid for	Recess
	[mm]	[mm]	[--]	[mm]
TE25050	25	50	TPPO $\varnothing 4-4,5$	Tx40
TE25090		90		

TE

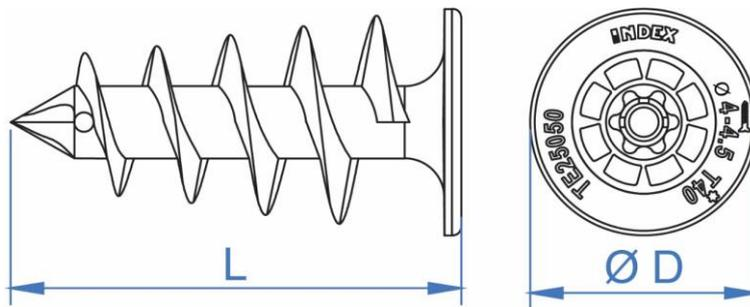

3. PRODUCT INSTALLATION

HOLLOW AND SOLID MATERIALS

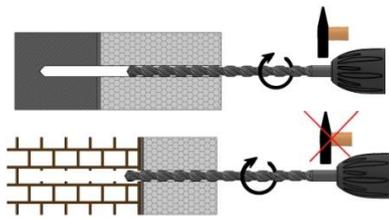

Drill to the specified diameter and depth values in previous tables. Drill position in rotary or hammer mode in case of solid material. In case of hollow materials do not use hammer mode to prevent damaging the inside of the base material. Reduce the drill speed when it seems that the drill bit is close to the inside of the base material.

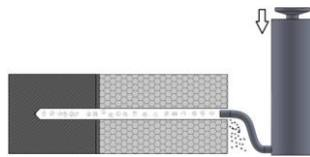

Clear the drill holes completely of dust and fragments.  
Use air pump and brush.

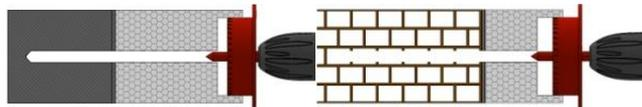

\* In case of a countersunk installation use a cutting tool to make a hole in the insulation material.

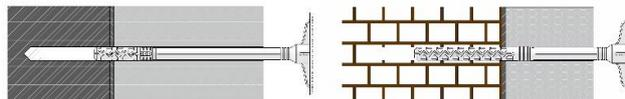

Set-in the anchor through the material to be fixed, without inserting manually, if possible, if not use a hammer.

STANDARD

CONTERSUNK

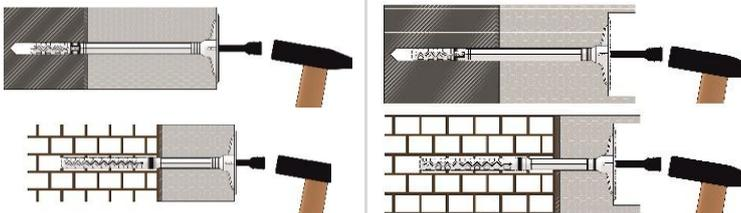

Nail-in the expansion pin by hitting it until the collar of the plug gets on the same level of the surface of the material to be fixed.

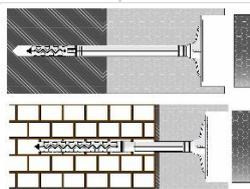

\*In case of a countersunk installation set-in a plug or the cut part of the insulation.

STANDARD

CONTERSUNK

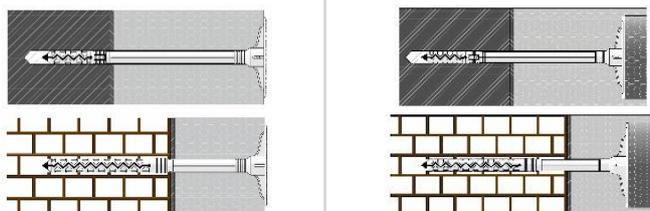

Correctly installed anchor.

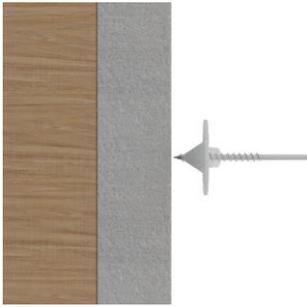
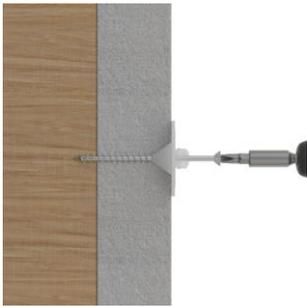
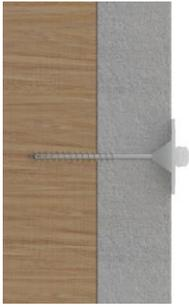
3.2 AIS-W IN WOOD	
	<p>Place the washer in the intended spot on the insulation material.</p>
	<p>Screw until the washer is in contact with the insulation material. Reduce the screwing speed when the installation is close to be finished so the washer doesn't go through the insulation.</p>
	<p>Screw through the insulation material until the wood is reached.</p>
	<p>Once the screw has reached its final position, close the washer using the plug that comes with it and the installation will be finished.</p>

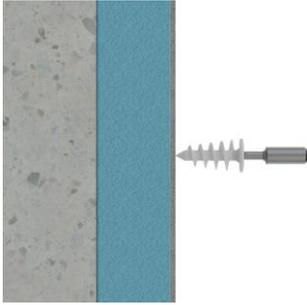
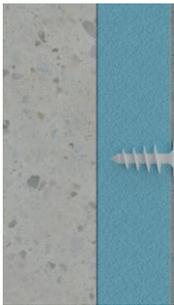
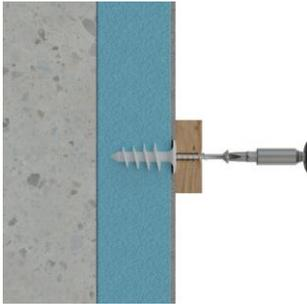
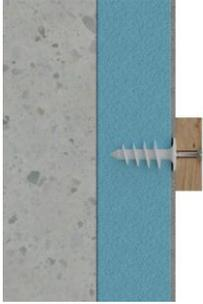
3.3 TE IN INSULATION PANELS	
	<p>Screw the spiral anchor in the insulation material. High density material is required for such fixing. Screw through the plaster layer in case of need.</p>
	<p>Screw until the anchor's head is levelled with the insulation panel. Reduce the screwing speed when the installation is close to be finished so the anchor doesn't go through the insulation.</p>
	<p>Screw through the fixture.</p>
	<p>Once the screw has reached its final position the fixing will be finished.</p>

4. MATERIAL BASE

4.1 CHARACTERISTICS

MATERIAL	PICTURE	DRILLING METHOD	STANDARD	DENSITY $\rho$ [kg/m <sup>3</sup> ]	MINIMUM COMPRESSIVE STRENGTH (N/mm <sup>2</sup> )
Concrete		Rotary + hammer	EN 206	--	C12/15
Concrete		Rotary + hammer	EN 206	--	C16/20 to C50/60
Clay brick MZ		Rotary + hammer	EN 771-1	$\geq 2,00$	$\geq 20$
Silicate KS		Rotary + hammer	EN 771-2	$\geq 2,00$	$\geq 20$
Vertically perforated clay bricks Porotherm		Rotary	EN 771-1	$\geq 0,80$	$\geq 20$
Calcium silicate hollow blocks KSL		Rotary	EN 771-2	$\geq 1,60$	$\geq 20$
Lightweight concrete blocks		Rotary	EN 771-3	$\geq 0,88$	$\geq 20$
Aerated Concrete AAC2		Rotary	EN 771-4	$\geq 0,35$	$\geq 2$

**4.2 SELECTION TABLE ETICS FIXINGS**

	Category	Material	AIS-C	AIS-S	AIS	AIS-M	AIS-W	TE
Base Material	A	Concrete	✓	✓	✓	✓	--	--
	B	Solid masonry	✓	✓	✓	✓	--	--
	C	Perforated or hollow masonry	✓	✓	--	--	--	--
	D	Lightweight concrete with open structure	✓	✓	--	--	--	--
	E	Aerated concrete	--	✓	--	--	--	--
	--	Wood	--	--	--	--	✓	--
	--	Metal	--	--	--	--	✓	--
Insulation		Expanded polystyrene (EPS)	✓	✓	✓	✓	✓	✓
		Mineral wool (MW)*	✓	✓	--	✓	--	--
		Shaped polyurethane (PUR)	✓	✓	✓	✓	✓	✓
		Extruded polystyrene (XPS)	✓	✓	✓	✓	✓	✓
		Expanded cork	✓	✓	✓	✓	--	--
Accessories		AIS-R	✓	✓	--	✓	--	--
		AIS-AM	--	--	✓	--	--	--

5. RESISTENCIAS

Characteristic resistances in materials shown, for an isolated anchor (without effects of edge distances and spacing between anchors) it is indicated in the next table (1kN ≈100kg):

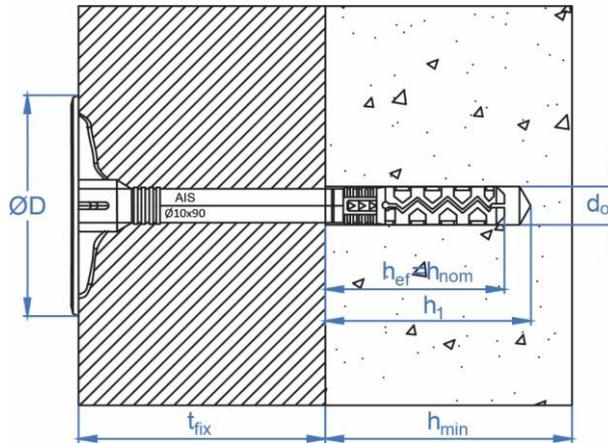

MATERIAL	PICTURE	CHARACTERISTIC RESISTENCE N <sub>Rk</sub> [kN]					MAXIMUM RECOMMENDE LOAD N <sub>rec</sub> [kN]				
		AIS	AIS-C	AIS-S	AIS-M	TE	AIS	AIS-C	AIS-S	AIS-M	TE
Concrete C12/15		0,03	0,55	0,40	0,30	--	0,01	0,20	0,14	0,10	--
Concrete C16/20 to C50/60		0,03	0,80	0,55	0,30	--	0,01	0,29	0,20	0,10	--
Clay brick MZ		--	1,00	0,65	--	--	--	0,36	0,23	--	--
Silicate KS		--	0,40	0,35	--	--	--	0,14	0,13	--	--
Vertically perforated clay bricks Porotherm		--	0,10	0,10	--	--	--	0,04	0,04	--	--
Calcium silicate hollow blocks KSL		--	0,65	0,40	--	--	--	0,23	0,14	--	--
Lightweight concrete blocks		--	0,20	0,30	--	--	--	0,07	0,11	--	--
Aerated Concrete AAC2		--	--	0,10	--	--	--	--	0,04	--	--
EPS		--	--	--	0,07	--	--	--	--	--	0,02
XPS		--	--	--	0,11	--	--	--	--	--	0,03
PUR		--	--	--	0,14	--	--	--	--	--	0,04

## 6. OFFICIAL DOCUMENTATION

The following documents are available through our Sales Department or on our official website: [www.indexfix.com](http://www.indexfix.com):

- European technical Assessments ETA-21/0823 plastic anchor for diameter 10 mm for fixing of external thermal insulation systems